

**THE
ENERGY MACHINE
OF
JOSEPH NEWMAN**

**THE
ENERGY MACHINE
OF
JOSEPH NEWMAN**

by
Joseph Westley Newman

An Invention Whose Time Has Come

Written and published by Joseph W. Newman
(*Edited by Evan R. Soule, Jr.*)
NEW ORLEANS, LOUISIANA

Copyright © 1984, 1985, 1986, 1987, 1990
by Joseph Westley Newman

SIXTH EDITION, First Issue

ISBN: 0-9613835-6-9

Library of Congress Catalogue Card No.: 84-90652

ALL RIGHTS RESERVED. Except for use in any review, the reproduction and/or utilization of this book in whole or in part in any form by any electronic, mechanical, or other means now known or hereafter invented, including xerography, photocopying and recording, or in any information storage and retrieval system, is forbidden without the permission of the author and publisher, Joseph W. Newman, Route 1, Box 52, Lucedale, Mississippi 39452.

Edited by: Evan R. Soulé, Jr.

Instructional drawings: Evan R. Soulé, Jr.

Typeset by E. Christine Munson in Garamond on a Compugraphic Editwriter & Evan R. Soulé, Jr. in Garamond on a MAC II Computer/Laserwriter

Printed by Land and Land Printing Company

Printed in the United States of America

Published and Distributed by:

Joseph Westley Newman

Route 1, Box 52

Lucedale, Mississippi 39452

Telephone: (601) 947-7147

Those companies/individuals interested in the proprietary manufacture and distribution of Mr. Newman's energy machine should contact Mr. Newman at: Route 1, Box 52, Lucedale, Mississippi 39452.

Frontispiece quotation based on an original quotation from Victor Hugo: *"No army can withstand the strength of an idea whose time has come."*

Thank You,
Joseph Westley Norman

DEDICATED TO ALL THE PEOPLES OF THE
WORLD WHO LIVE AND ARE YET TO BE BORN



Digitized by the Internet Archive
in 2009

<http://www.archive.org/details/energymachineofj00newm>

AUTHOR'S NOTE

I urge the reader to read this Book in its entirety, in the sequence of its development and presentation. This Book is developed logically from one concept to the next — just as I originally innovated the concepts which led to the creation of my energy machine. By skipping through the Book, the reader runs the risk of not thoroughly mastering the Theory upon which rests the technological innovation. The specific innovation is, in fact, less important to me than a *proper comprehension* of the Theory itself.

I also wish to assure the reader that the Editor and I are aware of accepted grammatical customs. I choose to use certain grammatical variations for purposes of conceptual emphasis and to encourage the reader to study carefully what is presented.

In Chapter One, I utilize a quotation from James Clerk Maxwell regarding the mechanical nature of a magnetic field in which he said: “In speaking of the Energy of the field, however, I wish to be understood literally. All energy is the same as mechanical energy ...” Historically, as it turns out, Maxwell has *not* been taken literally. In fact, this statement by Maxwell has been *literally ignored* by those who followed him. Perhaps James Clerk Maxwell’s statement would not have been ignored or overlooked had he written the words **I WISH TO BE UNDERSTOOD LITERALLY** with greater stylistic emphasis.

By intentionally “breaking” the flow of information (to the reader) with the use of quotation marks and parentheses, I am stylistically encouraging the reader to proceed carefully and “Master” what I teach.

The term “Master” should connote to the reader the same meaning as the historical distinction between “Master” and “Apprentice.” Please understand that I do not intend the term to have a derogatory implication to the reader. This is simply my way of encouraging the reader to understand (carefully and systematically) — rather than only memorize — what is presented in this Book.

My unorthodox treatment of certain words and grammatical devices is intended to partially counter-balance the psychological effects of a teaching system which often rewards memorization and ignores or penalizes a sincere, questioning attitude.

I must stress that my purpose is not in any way to condemn or question the intellectual ability of the reader. My sincere purpose is to question and improve the operational nature of the educational system.

EDITOR'S NOTE:

Those who understand the essential nature of Mr. Newman's energy machine may claim that its design is "simple and obvious." Of course it is. All great concepts and many major inventions throughout our history are very "simple and obvious" — but only *after* they are understood. The wheel is "simple and obvious," but it is nevertheless a very important invention that revolutionized our development as a species. One might ask: "Why was the wheel not 'obvious' to the countless human beings who lived before the inventor of the wheel?" The following quotation* from Christian Morgenstern answers this question quite elegantly:

"The obvious is that which is never seen until someone expresses it simply."

*Evan Soule, Jr. wishes to express his gratitude to physicist Andrew J. Galambos for bringing to his attention the above quotation by Christian Morgenstern, and for sensitizing him to the nature of innovation via a proper perspective for that which is "obvious." Professor Galambos has actually re-stated Morgenstern's quotation: "*The obvious is that which is never understood until someone expresses it simply.*" [Professor Galambos was originally informed of the Morgenstern quotation by Mr. Jerome Smith.]

Acknowledgements

I wish to express my deepest thanks and love to my Dear Wife, Margaret Ellen Green Newman, who has always demonstrated unending patience and faith in me and in the importance of my work. She has always eagerly offered to help in any capacity whatsoever to see such work to its completion. She has always demonstrated a deep and understanding love for me in spite of my unbending determination to achieve the completion of my work above all else. She has been and is the perfect wife for me. Her beauty, loving personality, and famed cooking ability have been an additional asset to my efforts. My love for her and with her is multiplied by our young son — Gyromas — of two years. I have named my son after my work and for him I have written a song concerning his special name which I sing to him to inspire and awaken his young mind. *Betrayed By MOST! see Page 350*

To Mr. Garland Robinette I owe a special thanks and my respect. As a top news anchorman with WWL-TV in New Orleans, Mr. Robinette has conducted himself in a more scientific manner with respect to discovering the truth of the operability of my energy machine than have most of the scientists who have seen or heard Mr. Robinette's news coverage of this invention. Mr. Robinette's extremely professional work not only *triggered* the involvement of other news media and scientists, but his work also led to financial assistance becoming available. Mr. Robinette spoke out when others were petrified to do so and his news coverage was based on *facts*, not wild speculation, biases, and prejudices. Mr. Robinette is a compliment and asset to his profession. In addition, Mr. Robinette is a very special person who truly cares about the benefits of my Invention to you, the *People*.

To Mr. Evan Soule', Jr. — a talented teacher and artist in New Orleans — I also owe special thanks and respect. Mr. Soule' has edited this Book and prepared all the finished drawings which are extremely professionally executed. Mr. Soule' has performed far more than this. He has put his very Essence into the editing, preparation, and production of this Book in order to enable it to be as appealing as possible to the reader. Mr. Soule' has fought vigorously with his pen against some of my unscrupulous adversaries. He has also vigorously discussed and endorsed my work with other scientists and members of the news media. Mr. Soule' is a special person who continuously works on behalf of my innovations becoming a reality for you, the *People*.

I wish to sincerely thank and give respect to the numerous scientifically-educated individuals listed in Chapter Seven who had the Scientific Courage to speak out on my behalf when it was not fashionable. All of these individuals are a compliment to the word "Scientist."

My very special thanks to Dr. Robert Smith of NASA, Dr. Roger Hastings of Sperry-Univac, and Engineer Milton Everett, formerly with the Mississippi Department of Energy — who spoke out first.

Joseph Westley Newman

Table of Contents

Chapter	Page
1. THE PROPER HISTORICAL PERSPECTIVE	1
2. GYROSCOPIC ACTIONS	4
3. TECHNICAL DESCRIPTION OF DRAWINGS	12
4. EXPLANATION FOR A WORKING INVENTION	15
5. DECLARATION BY DR. ROGER HASTINGS FOLLOWING EXTENSIVE TESTING ON 5,000 AND 900 LB. UNITS	22
6. DESCRIPTION OF SMALLER UNIT WITH AN AFFIDAVIT BY DR. ROGER HASTINGS	36
7. ADDITIONAL AFFIDAVITS	40
8. ANALOGIES USEFUL IN UNDERSTANDING THE TECHNICAL SYSTEM	49
9. EXPLANATION OF INTERNAL ACTION WITHIN MY ENERGY MACHINE AND DISCUSSION OF COMMUTATOR DESIGNS	60
10. QUANTUM MECHANICS	71
11. LIGHT	74
12. USEFUL "WORK, FORCE, AND POWER" EQUATIONS	80
13. THE STATIC EMBODIMENT (ENERGY MACHINE)	83
14. EFFECTS DEMONSTRATED BY PARTICLES WITHIN ELECTROMAGNETIC FIELDS	85
15. THE GAS EMBODIMENT (ENERGY MACHINE)	88
16. GRAVITY	91
17. INERTIA	96
18. HEAT AND THE THREE LAWS OF THERMODYNAMICS	102
19. ASTRONOMY	112
20. ACHIEVEMENT VS. APATHY	154
21. THE PROPER TEACHING SYSTEM	238
22. RECOMMENDED PROOF OF GOD'S EXISTENCE	243
23. THE MERGER BETWEEN MECHANIZATION AND ECONOMICS	253
24. THE PATENT SYSTEM	258
25. THE JUDICIAL SYSTEM	274
26. THE PURSUIT OF TRUTH	280
27. APPENDIX	283



Chapter 1

THE PROPER HISTORICAL PERSPECTIVE

"I cannot conceive curved lines of force without the conditions of a physical existence in that intermediate space."

— Michael Faraday

In my search for Absolute Truth over the last nineteen years, I have often questioned why the conclusions I drew from present physics, electrical engineering, and astronomy teachings were not in accord with the scientific community's conclusions.

The difference lies in the fact that during the last twenty-three years I have made my livelihood solely from inventing. This is a profession that requires continual questioning as to "HOW" and "WHY," followed by deep, creative thought concerning realistic improvements.

In contrast, the present teaching system from grammar school through college is one of *memorization*. The more capable a student is in memorizing the textbooks used within educational institutions, the better grade he or she receives. Moreover, the time allotted for learning the basics in college is very hurried. There is little or no time for deep, creative thinking as to "HOW" and "WHY." This system has been, and continues to be, very detrimental to the progress of science.

The progress of our human species is dependent upon creativity undergoing a process of *continuing physical expansion*. All technically-oriented individuals have a sensitive and moral obligation to encourage the creative individual, in whom lies the future improvement of the human race. In many instances, the technological realization of a scientific concept will precede the scientific explanation or expectation by the scientific community or other technical individuals.

The facts relative to the history of the advancement in every aspect of science — medicine, physics, chemistry, astronomy, geology, electrical engineering — clearly show that because a subject matter is taught in accordance with a given line of thought at that instant in time does not make it fact.

However, even at this late date many individuals within the scientific community and other technical individuals have clearly taken the position that anything taught in a given instant in time *is* fact.

If there were any merit to such a blind attitude, then the Earth would be flat and it would also be the center of the Universe, because such a "belief" was rigidly taught in past years. Actually, the present electric motor or generator would not exist because, prior to 1820, the teachings at that time stated that there was no connection between magnetism and electricity.

There are now and have been those who have blindly taken the position that there is no credibility to my Technical Process which describes my Pioneering Inven-

tion of Patent Application Number 179,474. Especially pertinent is the fact that I have described in extensive detail how a magnetic field consists of particles with a mechanical, *gyroscopic-type action* which can be understood and predicted and which occurs at the speed of light. Furthermore, *the energy in a magnetic field is the energy which comprises the atoms of the material from which the energy comes and is literally Einstein's Equation of $E = MC^2$* . Consequently, the mass (in the form of a gyroscopic particle) must *move* in a given direction at C , or the speed of light, and it must also *spin* at the speed of light.

"The energy in a magnetic field is the energy which comprises the atoms of the material from which the energy comes and is literally Einstein's Equation of $E = MC^2$."

I wish to pay tribute to Michael Faraday, whose work stimulated my search, and to James Clerk Maxwell. Both of these great scientists have seen even farther into the future in a way in which they have yet to receive full credit and recognition.

The following facts concerning these prestigious men were discovered by me many years after I had originally begun my search:

The following quotations are from a book entitled *Michael Faraday* by L. Pearce Williams [published by Chapman and Hall, Ltd., London, 1965]. Essentially, Michael Faraday understood the lines of force as real physical entities. His position was not shared by most other scientists of that time. This caused Faraday to remark on November 7, 1855:

"How few understand the physical lines of force! They will not see them, yet all the researches on the subject tend to confirm the views I put forth many years since. Thompson of Glasgow seems almost the only one who acknowledges them. He is perhaps the nearest to understanding what I meant. I am content to wait convinced as I am of the truth of my views." (page 507)

In correspondence between Michael Faraday and James Clerk Maxwell, Faraday disagreed at one point

with Maxwell's definition of the word "force." On page 514, Faraday states in a letter to Maxwell dated November 13, 1857:

"I [Faraday] perceive that I do not use the word 'force' as you [Maxwell] define it: 'the tendency of a body to pass from one place to another.' What I mean by the word is the source or sources of all possible actions of the particles or materials of the universe ..."

However, on the subject of the lines of force, Maxwell did agree with Faraday. On page 511, L. Pearce Williams writes:

"Maxwell, it would seem, was the only person besides Faraday who actually felt that the lines of force did exist and were not just an easy way to represent action at a distance."

The above quotations clearly show that Michael Faraday — possibly the greatest experimental genius that the world has ever known — strongly believed that the lines

at first hand. He combined the laws of electromagnetism into a simple, lucid mathematical statement — a set of famous relations known as Maxwell's equations. These provided the theoretical foundation of modern electromagnetic science — the basis of much, if not most, of our technological civilization."

Maxwell states on pages 72 and 73:

"I have hardly made a single experiment, and that the limit of my design is to show how, by a strict application of the ideas and methods of Faraday, the connection of very different orders of phenomena which he has discovered may be clearly placed before the mathematical mind."

From page 125:

"This work is Maxwell's crowning masterpiece: 'The theory I propose may ... be called a theory of the Electromagnetic Field because it has to do with the space in the neighborhood of the electric

***"How few understood the Physical lines of Force!"* — Michael Faraday**

of force of a magnet were real entities and consisted of some type of particles. He simply did not know how to mechanically explain or prove the existence of these particles.

Therefore, it is obvious from the above that Michael Faraday would have eagerly endorsed a consistent, *mechanical* explanation of these particles comprising the lines of force within a magnet which would *mechanically* explain why magnets and electrical charges attract and repel as well as why electric currents move in varying directions when a conductor moves relative to a given magnetic field.

In my original Disclosure Document (which is legally a part of my Patent Application) along with my Patent Application, I mechanically explain in detail all of the above — in addition to previously unexplained scientific observations — via *one, single mechanical explanation* of gyroscopic-type particles which comprise all matter (energy) in the Universe and generate all magnetic/electric fields. I will present a detailed, mechanical description of these particles in this Book, beginning with Chapter Three.

The following quotations are from a book entitled *James Clerk Maxwell: a Biography* by Ivan Tolstoy. [Published by Canongate Publishing, Ltd., Edinburgh, 1981.]

From pages 2 and 4:

"Maxwell was, and largely remains to this day, a physicist's physicist — appreciated and revered by those equipped to understand and savor his work

*or magnetic bodies, and it may be called a Dynamical Theory, because it assumes that in that space there is **matter in motion**, by which the observed electromagnetic phenomena are produced."* (Emphasis added.)

From page 125 continued:

"The storage of electromagnetic energy in the field is then discussed in terms which no longer require the aether model. After writing down his final relations for the electromagnetic field (Maxwell's equations), he puts it this way:

"I have on a former occasion attempted to describe a particular kind of motion and a particular kind of strain, so arranged as to account for the phenomena. In the present paper I avoid any hypothesis of this kind; and in using such words as electric momentum and electric elasticity in reference to the known phenomena of the induction of currents and the polarization of dielectrics, I wish merely to direct the mind of the reader to mechanical phenomena which will assist him in understanding the electrical ones. All such phrases in the present paper are to be considered as illustrative, not explanatory.

"In speaking of the Energy of the field, however, I wish to be understood literally. All energy is the same as mechanical energy, whether it exists in the form of motion or in that of elasticity, or

in any other form. The energy in electromagnetic phenomena is mechanical energy. The only question is, Where does it reside? On the old theories it resides in the electrified bodies, conducting circuits and magnets, in the form of an unknown quality called potential energy, or the power of producing certain effects at a distance. On our theory it resides in the electromagnetic field, in the space surrounding the electrified and magnetic bodies, as well as in those bodies themselves, and is in two different forms, which may be described without hypothesis as magnetic polarization and electric polarization, or, according to a very probable hypothesis, as the motion and strain of one and the same medium. ' ' (Emphasis added.)

It is obvious from the above facts that Maxwell believed that there is *matter-in-motion in a magnetic field* and that there was some type of mechanical property which created the observed electromagnetic phenomena. Maxwell, like Faraday, simply did not know how to physically prove or mechanically explain the phenomena.

I was in the same intellectual position during March, 1965 when I read and studied the nature of Faraday's Generator. At that time, I also concluded that a magnetic field was composed of particles that possessed some form of mechanical action which created the observed results then being taught and accepted. In addition, I also concluded that these particles moved at the speed of light. However, like Faraday and Maxwell, I could not

sight, and, as a result, *still teaches the old theory* which Maxwell referred to as: "the form of an unknown quality called potential energy, or the power of producing certain effects at a distance."

[I will discuss in this Book the actual nature of "potential" energy as opposed to kinetic energy.]

The above facts clearly show that two of the most prestigious men of science — *before the fact* — already endorsed a basic tenet of my Disclosures. The above quotations, the factual results that will be presented in this Book, and the fact that as of this writing over thirty (30) extremely qualified, scientifically-minded individuals have put forth statements verifying that my technological prototypes have a greater energy output than external energy input into my system, most certainly overcome the objections of mere disbelief on the part of others who have not studied my concepts.

It is obvious that neither Maxwell or Faraday could mechanically explain or prove the existence of these particles, which I will discuss in this Book, nor did they understand or openly predict how one could obtain greater energy from a mass or magnetic field than the energy put into the system. Yet, these great men instinctively laid the ground work of endorsement for anyone who could mechanically explain these particles and therefore expand upon their own sincere and dedicated efforts to provide a mechanical explanation for electromagnetism.

I have accomplished this understanding and much more. By their statements, Faraday and Maxwell have ef-

"In speaking of the Energy of the field, however, I wish to be understood literally. The energy in electromagnetic phenomena is mechanical energy." — James Clerk Maxwell

prove that my Hypothesis was true at that time. I then realized that one must mechanically understand the *essence of these particles* before one could efficiently harness their energy. I eagerly accepted this massive challenge and for well over a decade I studied, experimented, and put forth deep, creative thought which resulted in the (U.S. Patent Office) Disclosure Document of over 130 pages and the patent application Serial No. 179,474*. This in turn resulted in my developing a Unified Field Theory which was no longer only a theory **but a Technical Process which demonstrates and teaches the mechanical disclosure of a new source of energy and is so disclosed in this Book.**

It is historically apparent that because Faraday and Maxwell could not prove or mechanically explain these energy particles, the present scientific community has not grasped the essence of Maxwell's and Faraday's in-

fectively endorsed a basic tenet of my Disclosures before the fact, even though they had no explicit, mechanical explanation for their statements.

The importance, originality, and factual corroboration of my Disclosure will speak for itself.

SURELY I AM ENTITLED TO PIONEERING PATENT PROTECTION FOR THIS REVOLUTIONARY INVENTION.

* This application is a continuation-in-part of the prior copending application Serial No. 110,834, filed January 9, 1980, which in turn is a continuation-in-part of prior patent application Serial No. 23,136, filed March 22, 1979, and Serial No. 25,907, filed April 2, 1979.

Chapter 2

GYROSCOPIC ACTIONS

"The way in which Faraday made use of his lines of force in co-ordinating the phenomena of electric induction shows him to have been a mathematician of high order, and one from whom the mathematicians of the future may derive valuable and fertile methods."

— James Clerk Maxwell

I will begin with the scientific facts concerning my initial reading in March, 1965 on the nature of Michael Faraday's Generator.

Anyone who cannot recognize the veracity of certain conclusions that I understood when I initially studied Faraday's facts has been unjustly influenced by the teaching process which rewards one for memorization and discourages questioning of the subject matter taught.

As you read the following list of experimental facts concerning Faraday's generator, you will retrace the steps of my initial readings during March 1965. With open eyes and an open mind, question for yourself what would happen under the conditions described below.*

The facts of Faraday's Generator:

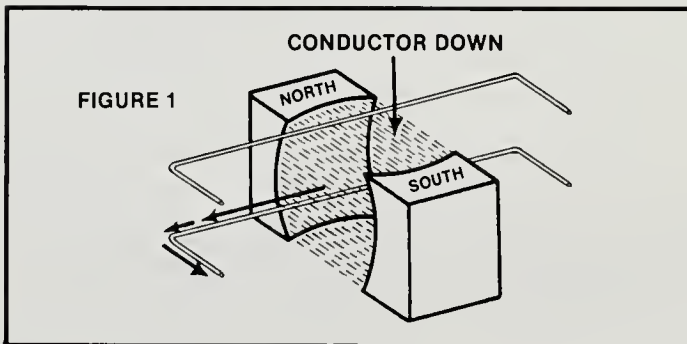

1. Push a conductor wire down and through a magnetic field at right angles to the lines of force and the electric current will flow to the left as drawn.

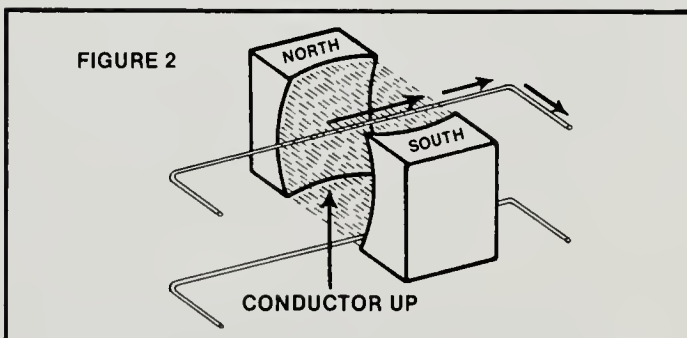

2. Push a conductor up and through a magnetic field at right angles to the lines of force and the electric current flows to the right as drawn (opposite to Figure 1 above).

*This openmindedness to new knowledge may be difficult for those taught by a system which rewards memorization and discourages the very type of questioning employed by the Author.

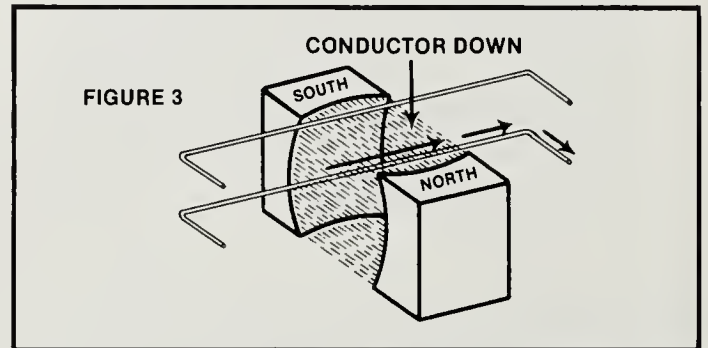

3. Flip over the magnet 180° and the direction of the electric current flow will be reversed from that of Figures 1 and 2 above, although the direction and motion of the conductor remain the same (compare Figure 3 to Figure 1 and observe opposite results).

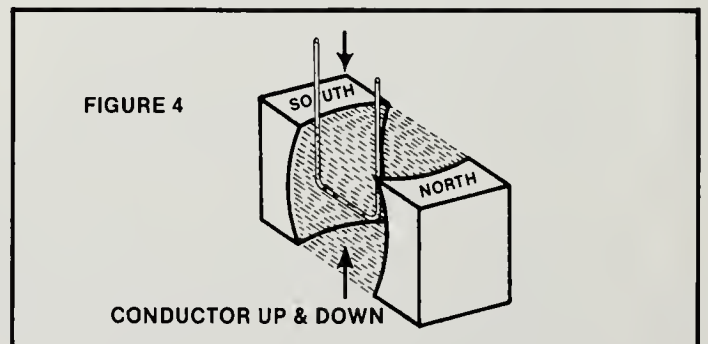

4. Push the conductor "down" or "up" in a motion *parallel* to, and through the magnetic lines of force; no electric current will flow despite a vigorous or energetic pushing effort.

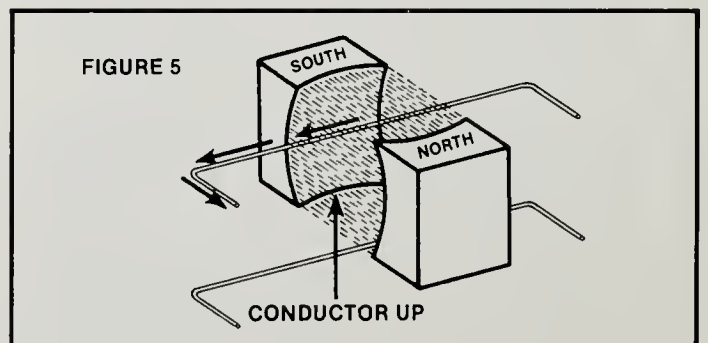

5. However, although the conductor can be very slowly pushed at right angles to the magnetic lines of force, the resulting electric current will move at the *speed of light*.

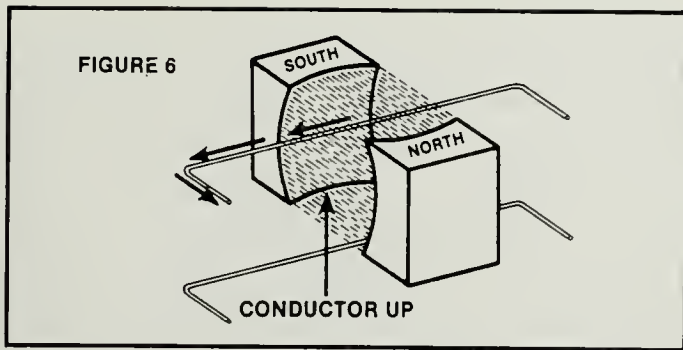

6. The conductor can be disconnected from the ammeter, flipped over 180° , reconnected to the ammeter to repeat the same motions of the conductor through, and at right angles to the magnetic lines of force (as in Figures 1-3). Identical results of the electric current flow will then be observed even though the conductor has been flipped over 180° . (See Figures 5 and 6: the conductor in Figure 6 has been flipped over 180° from that of Figure 5, yet the direction of current flow is identical.)

7. The conventional teachings would suggest that the above-discussed electric current flow was a result of electron flow in the conductor and that *nothing* came from the magnetic field. Also, conventional teachings state that the magnetic lines of force are imaginary, consisting of Potential Energy and *no* Kinetic Energy. [This claim was believed to be justified because no current flow was observed when the conductor was motionless in a magnetic field. There is no merit to this position when one knows that one can vigorously move a conductor parallel to magnetic lines of force and no current flow will occur.]

8. As I studied the above facts of Faraday's Generator, I concluded that the conventional teachings of No. 7 above were totally incorrect and that such a conclusion completely ignores the known facts presented by Faraday's Generator.

9. Facts 1-6 above clearly proved to me that a magnetic field consists of:

A. particles which have mechanical characteristics. I asked myself, "How else could these particles 'know' which way to travel and why else would the direction of current flow be so dependent upon the magnetic field and totally independent of the conductor itself?"

B. particles moving at the speed of light within the magnetic field. The facts prove to me that one did not impart the velocity of light to electric current flow by moving a conductor slowly through a magnetic field. Rather, the facts demonstrated that the resulting electric current flow consisted of an entity which already traveled at the speed of light. The slow movement of the conductor at right angles to that entity had simply mechanically deflected the particle from its normal path. [Such action is similar to that of a bullet being deflected by hitting a metal plate or body of water at

the proper angle which results in the bullet being deflected from its original path.]

However, I was still puzzled. I asked myself, "Why did the up and down motion of the deflecting conductor produce opposite-direction deflection of this mechanically-natured particle which moved at the speed of light? Why did the deflection reverse when the magnet was flipped over 180° ? And why, when the conductor moved parallel to these mechanically-natured particles (which were moving at the speed of light), was no current flow produced?" This latter question indicated to me that no proper deflection of the particles occurred in the mechanical position of force of the conductor.

Also, I asked myself, "When the conductor was motionless in the magnetic field (consisting of particles with mechanical characteristics and moving at the speed of light), why was no current flow produced?" This observation indicated that there was no proper deflection of the particles occurring in the mechanical position of the conductor.

10. Summation of my thoughts in the early months of 1965:

Faraday had invented an important invention — the electric generator — but he had invented an *inefficient* invention because one always obtained less energy from a system than the energy put into that system: yet, the facts clearly showed that the system consisted of an orderly flow of *Kinetic Energy*. This Kinetic Energy consists of a mechanically-oriented particle which moves at the speed of light. Therefore I knew that in order to construct the proper technological mechanism which could utilize this energy, I must simply understand the essence of the entire system.

In addition to making my living by other successful inventions, the next three years consisted of thousands of hours of testing, studying, and thinking to search for the truth concerning the nature of this mechanically-oriented particle. During this time, the same question dominated my thoughts: How did the particles of a magnetic field "know" which way to travel? In retrospect, the answer is extremely simple, but seemed very difficult to me at the time since I had never taken a physics course and had been teaching myself many varied subjects.

At this time in my life, I began to work on another invention consisting of a flywheel which acted as a "mechanical storage battery" for a bicycle. This flywheel caused the bicycle to automatically react as a "wheelie." Such "stored mechanical energy" within the flywheel suggested to me the stabilizing influence of a gyroscope. I then became fascinated with understanding the essence of the gyroscope and thereafter I learned the answer to the questions dominating my thoughts concerning the explicit, mechanical characteristics of the particles comprising a magnetic field and traveling at the speed of light.

11. These particles consist of a gyroscopic mechanical action which can be operationally (mechanically) understood and predicted! Let the following facts prove or disprove this Theory:

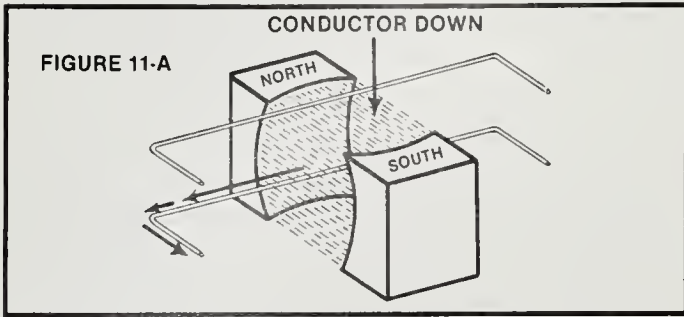

Figure 11-A Move a conductor down at a right angle to a magnetic field and *the current flow moves left.*

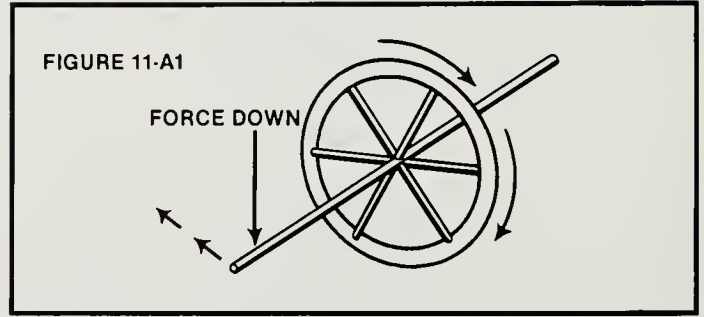

Figure 11-A1 Apply a downward force to the axis of a spinning gyroscope and it will pivot at a right angle to the force (in this case *pivot left*). Now imagine that this gyroscope has a forward direction at the speed of light.

THE ANALOGY OF THE ABOVE TWO EXAMPLES IS SCIENTIFICALLY EXACT!

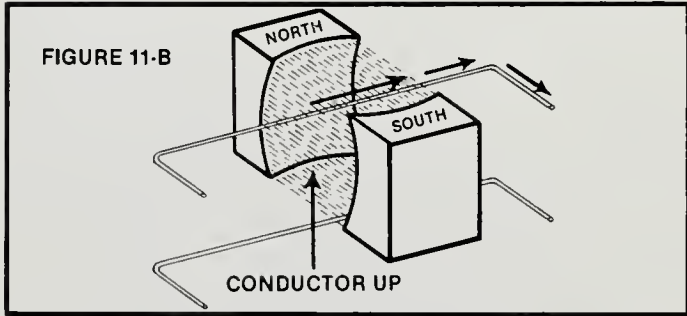

Figure 11-B Move the conductor "up" at right angles to the magnetic field and *the current flows right and opposite to Figure 11-A above.*

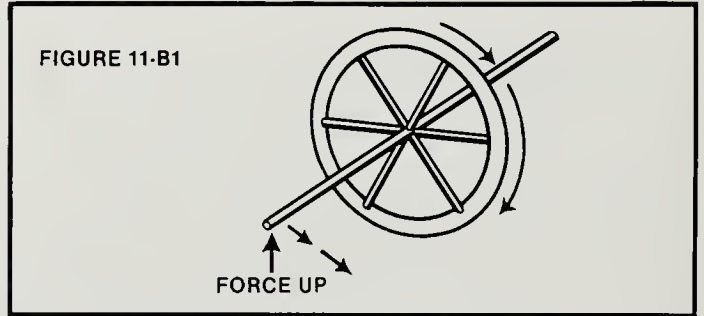

Figure 11-B1 Apply an upward force to the axis of the spinning gyroscope and it will pivot at right angles to the force. In this case, the gyroscope *pivots right* and opposite to Figure 11-A1 above. Now imagine that this gyroscope has a forward direction at the speed of light.

AGAIN, THE ANALOGY OF THE ABOVE TWO EXAMPLES IS SCIENTIFICALLY EXACT!

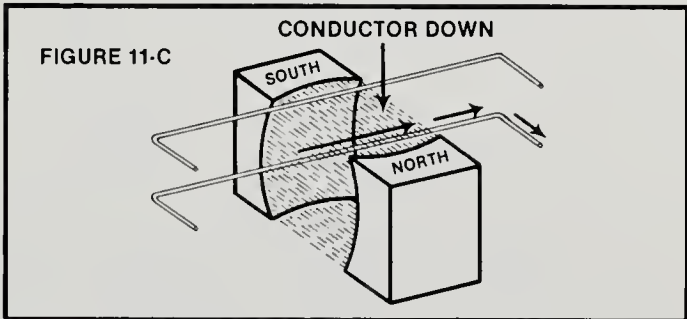

Figure 11-C Flip the magnets over 180° and repeat the actions of Figure 11-A above. The current flow direction will be *right and opposite to that of Example 11-A even though the force direction is the same.*

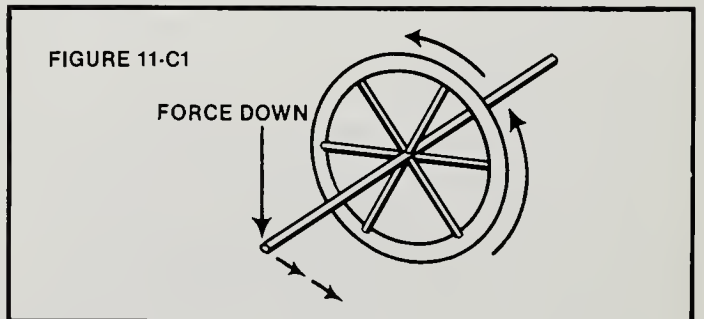

Figure 11-C1 Flip the spinning gyroscope over 180°. Repeating the actions of Figure 11-A1 above, *the gyroscope will pivot at right angles to the force, but will now pivot right and opposite to that of Figure 11-A1 above, even though the force direction is the same.* Now imagine that this gyroscope has a forward direction at the speed of light.

AGAIN, THE ANALOGY OF THE ABOVE TWO EXAMPLES IS SCIENTIFICALLY EXACT!

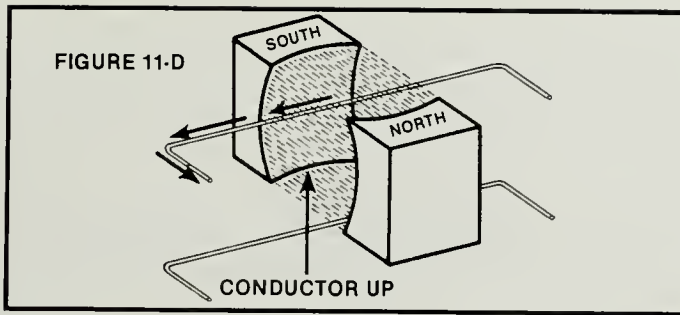

Figure 11-D Repeat the actions of Figure 11-B and the current flow will be left and opposite to Figure 11-B even though the force direction is the same.

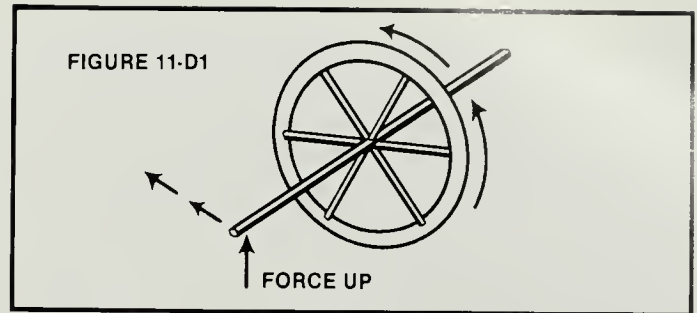

Figure 11-D1 Repeat the actions of Figure 11-B1: the gyroscope will pivot at right angles to the force, but will now pivot left and opposite to Figure 11-B1 even though the force direction is the same. Now imagine that this gyroscope has a forward direction at the speed of light.

AGAIN, THE ANALOGY OF THE ABOVE TWO EXAMPLES IS SCIENTIFICALLY EXACT!

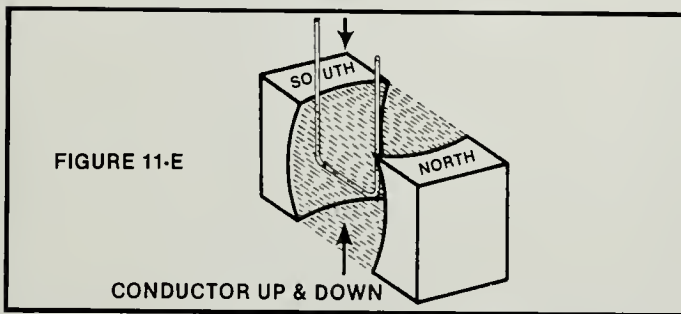

Figure 11-E Move the conductor vigorously “up” and “down” through the magnetic field, maintaining the conductor force parallel to the magnetic lines of force and no current flow will result.

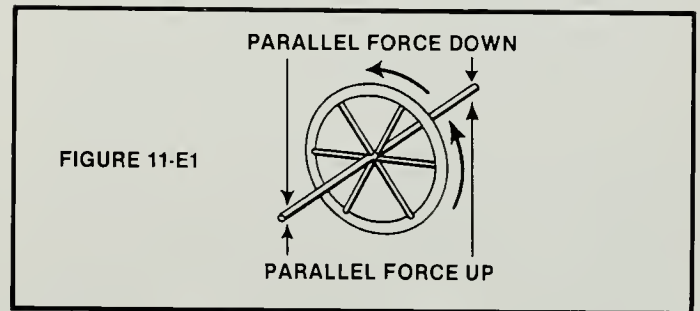

Figure 11-E1 Apply an “up” and “down” force parallel to the axis of the spinning gyroscope. Regardless of how energetically the force is applied, as long as the force remains parallel, the gyroscope will not pivot even though it has a forward motion at the speed of light.

AGAIN, THE ANALOGY OF THE ABOVE TWO EXAMPLES IS SCIENTIFICALLY EXACT!

“These particles consist of a ‘gyroscopic mechanical action’ which can be operationally (mechanically) understood and predicted!”

¹¹
F. The reason that a stationary conductor in a magnetic field (generated by and consisting of gyroscopic particles spinning and moving at the speed of light) does not produce current flow is very simple. The fundamental Laws for the Mathematics of Probability (Statistics of Large Numbers) states that as many of the gyroscopic particles will pivot left as pivot right due to the random motion of the atoms comprising the conductor. Such action causes a cancellation effect. The same is true if, from all directions, one randomly applies a force to the axis of a spinning gyroscope. It simply will *not* pivot if the random forces are fast.

AGAIN, THE ANALOGY OF THE ABOVE TWO EXAMPLES IS SCIENTIFICALLY EXACT!

¹¹
G. When one brings a conductor “down” or “up” at right angles to a magnetic field, the random motion of the atoms within the conductor does not affect the system because there is a general drift direction of the “up” and “down” force applied to the gyroscopic particles comprising a magnetic field. This effect is similar to an airflow consisting of gas molecules in random motion within the airflow, but also possessing a general drift direction which will apply a force to a windmill, etc. If the airflow ceases, however, the windmill will not turn even though the molecules of gas — while still moving at high velocities — are nonetheless in a random motion which cancels the force applied to all sides of the windmill.

The same effect is true if one applies a random force to the axis of a gyroscope. *If the random force has a given drift direction of force, the gyroscope will pivot at right angles to that drift directional force.*

AGAIN, THE ANALOGY OF THE ABOVE TWO EXAMPLES IS SCIENTIFICALLY EXACT!

At this point in time, the facts I had assembled had convinced me that my initial thoughts in 1965 were indeed correct. A magnetic field *does* consist of discrete particles which move forward at the speed of light and possess mechanically-identifiable characteristics which are identical to those possessed by a gyroscope. Such characteristics can be mechanically understood and predicted.

By this time, however, I also mechanically explained other questions which I had conceived regarding the nature of a magnetic field. Questions such as:

Why, in a mechanical sense, does a magnet attract and repel other magnets?

Why, in a mechanical sense, do electric charges attract and repel?

What is the energy in a magnetic field and what is its source?

Did the energy used in creating a permanent magnet have any bearing upon the strength or energy contained within a magnetic field emitted from the permanent magnet once it was made?

12. In the early part of 1965, I eagerly researched the known facts concerning the creation of a permanent magnet. Because I instinctively knew that if the strength of a magnetic field was solely relative to the energy input, then I would know I was incorrect. But if the strength of the magnetic field was *independent* of the energy input, then I would be even more assured that I was correct.

Upon examining the known facts concerning permanent magnets, I again knew I *was* correct and such facts are listed as follows:

12
A. For a given energy input into varying materials of identical volume, the generated strength of the magnetic field varies drastically!

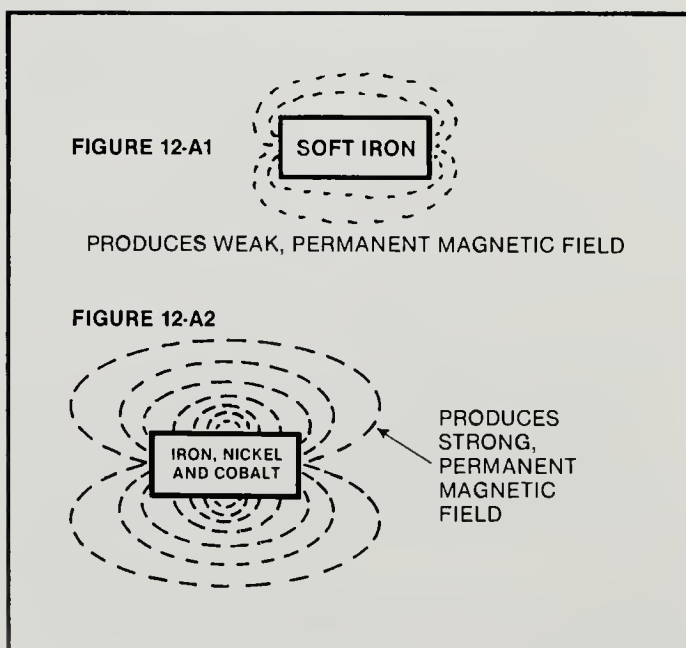

The same electrical energy input created extremely variable field strengths! I therefore instantly knew that the strength of the magnetic field had to be a result of the nature of the atoms comprising the material and *not* a result of the electrical energy input.

12
B. The facts further demonstrated that the strength of the magnetic field was observed to increase as more atoms within the material became aligned!

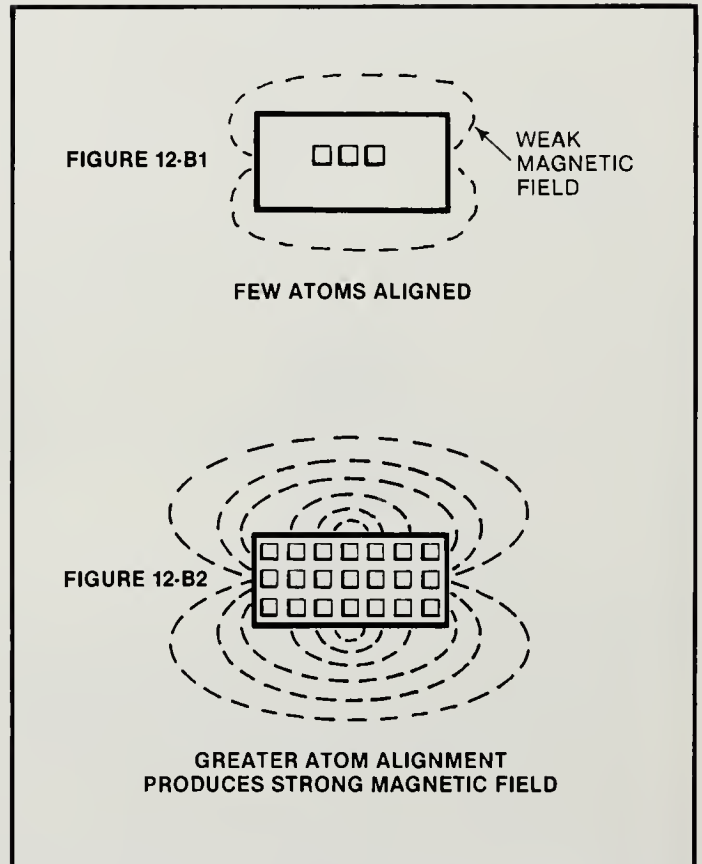

FACT B therefore further corroborated FACT 12-A above as being correct.

12
C. The facts also taught that once the maximum atom alignment of a given material was achieved, then *no* amount of electrical input would continue to increase the magnetic field of that material! (See Figure 12-B2 above.)

It was obvious to me from this conclusion that the strength of the magnetic field of a given material was not relative to the electrical energy input. Once the maximum atom alignment of a material was achieved, one could increase the energy input 1000 times and there would be *no* increase in the strength of the magnetic field of the permanent magnet. Therefore, FACT 12-C further corroborated FACT 12-A above.

12
D. The facts also taught that if one took a permanent magnet (such as in Figure 12-D1 below) which has a strong magnetic field and heated the magnet to its Curie temperature, the magnetic field would virtually disappear! (See Figure 12-D2 below.)

FIGURE 12-D1

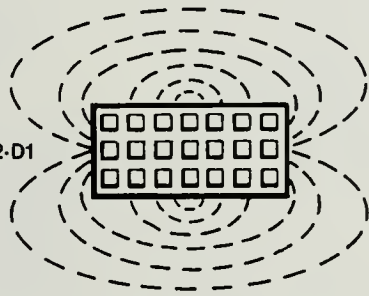

STRONG MAGNETIC FIELD PRODUCED BY GREATER ATOM ALIGNMENT

FIGURE 12-D2

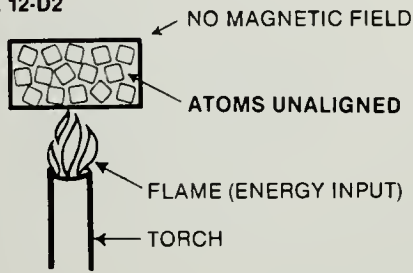

Again, it was obvious to me that the magnetic field disappeared in Figure 12-D2 because the heat input created a random atomic motion and non-alignment within the material. One can clearly see that in Figure 12-D2 one is transferring energy into the system of the magnetic material, *i.e.*, one is not taking energy from the magnetic material and yet the magnetic field virtually disappears.

13. The conclusions which I drew from the above FACTS I - 12D clearly proved to me the following:

A. The energy in a magnetic field is the energy which comprises the component parts of the atoms from which the energy comes!

B. The energy in a magnetic field is therefore literally Einstein's Equation of $E = MC^2$!

C. The energy in a magnetic field must be moving in a direction at the speed of light and must also have a gyroscopic spin at the speed of light: *herein lies the mechanical essence of $E = MC^2$!*

The Kinetic Energy of a moving particle is $\frac{1}{2}MV^2$. If the particle is moving with speed V and also rotating about its axis at speed V , then the total Kinetic Energy is $\frac{1}{2}MV^2$ (for forward motion) plus $\frac{1}{2}MV^2$ (for the rotational motion [not $\frac{1}{2}I\omega^2$]) which equals MV^2 . If V is equal to C , then the total Kinetic Energy is equal to MC^2 . (Hypothetically, this particle is mathematically

an infinitely small entity which, in a literal and mechanical sense, moves laterally and rotationally to generate a gyroscopic [spiral] helix effect.)

D. The literal and mechanical configuration of a magnetic field is simply a result of the summation of atom alignment within the material from which the magnetic field is generated.

E. At this time, I had also mechanically explained why electric charges as well as magnets attracted and repelled. (Conventional teachings only state that "like" magnetic poles repel and "unlike" magnetic poles attract. It is also said that "like" electrical charges repel and "unlike" electrical charges attract. This is a superficial analysis.) The answer to such attraction/repulsion is simple. The gyroscopic spin has a mechanical action which causes the observed results and can be mechanically understood and predicted.

F. The same conventional and superficial analysis was also applied to electric charges, *i.e.*, "like" charges repel and "unlike" charges attract. My mechanical explanation concerning electric charges was developed 1 1/2 years before I understood the gyroscopic composition of magnetic fields. In essence, I mechanically viewed the electric charges as rotating arrows  similar to the mechanics of gear interaction. This enabled me to easily envision and draw the mechanical effects of attraction and repulsion. However, I did not call this mechanical effect of attraction and repulsion a gyroscopic effect since (at that time) I had still not studied gyroscopes. Upon understanding gyroscopes, I instantly understood that the mechanics I had originally drawn for electric charges was a gyroscopic action. The fact that the same mechanical explanation for gyroscopic action explained *both* magnetism and electric charges made me even more certain of the correctness of the mechanical explanation. [Electric charges consist of millions (plus) of gyroscopic particles and such charges will be discussed in more detail in a later chapter (Sections 29 A-M) discussing gravity.] At this point, you should first intellectually master the concept and mechanical nature of magnetism.

The following two pages of drawings describe MAGNETS IN REPULSION and MAGNETS IN ATTRACTION, (as well as electrical repulsion and attraction), visually explaining the discussion in 13 A-E. These drawings have been unselfishly produced for me by Mr. Evan R. Soule', Jr. (talented artist and teacher). See also the following pages presenting a Technical Description of the drawings. This Technical Description was also unselfishly written by Mr. Evan R. Soule', Jr. from information developed by me, with the purpose being that if Mr. Soule' could understand what I have taught, then as an experienced teacher he could put forth this information so that you, the reader, would also understand.

MAGNETIC FIELDS IN REPULSION

QUALITATIVE REPRESENTATION OF THE KINETIC ENERGY OF A MAGNETIC FIELD: GYROSCOPIC FUNDAMENTAL PARTICLES SIMULTANEOUSLY ROTATING (ON AN AXIS CONSISTING OF A GIVEN "LINE OF FORCE") AT THE SPEED OF LIGHT AND TRAVELING AT THE SPEED OF LIGHT ALONG THESE "LINES* OF FORCE" IN ACCORDANCE WITH EINSTEIN'S EQUATION OF $E=MC^2$

—*ACTUALLY "SHELLS OF FORCE"
IT IS THE GYROSCOPIC SPIN THAT PLAYS THE MAJOR ROLE OF ATTRACTION AND REPULSION IN MAGNETIC FORCES (EXACTLY AS SHOWN IN STATIC ATTRACTION AND REPULSION — SEE "PROOF A")

© COPYRIGHT, 1984, JOSEPH NEWMAN (LUCEDALE, MS)

Drawn by Evan Soule, Jr. (New Orleans, LA) based upon the original and copyrighted concepts of JOSEPH NEWMAN.

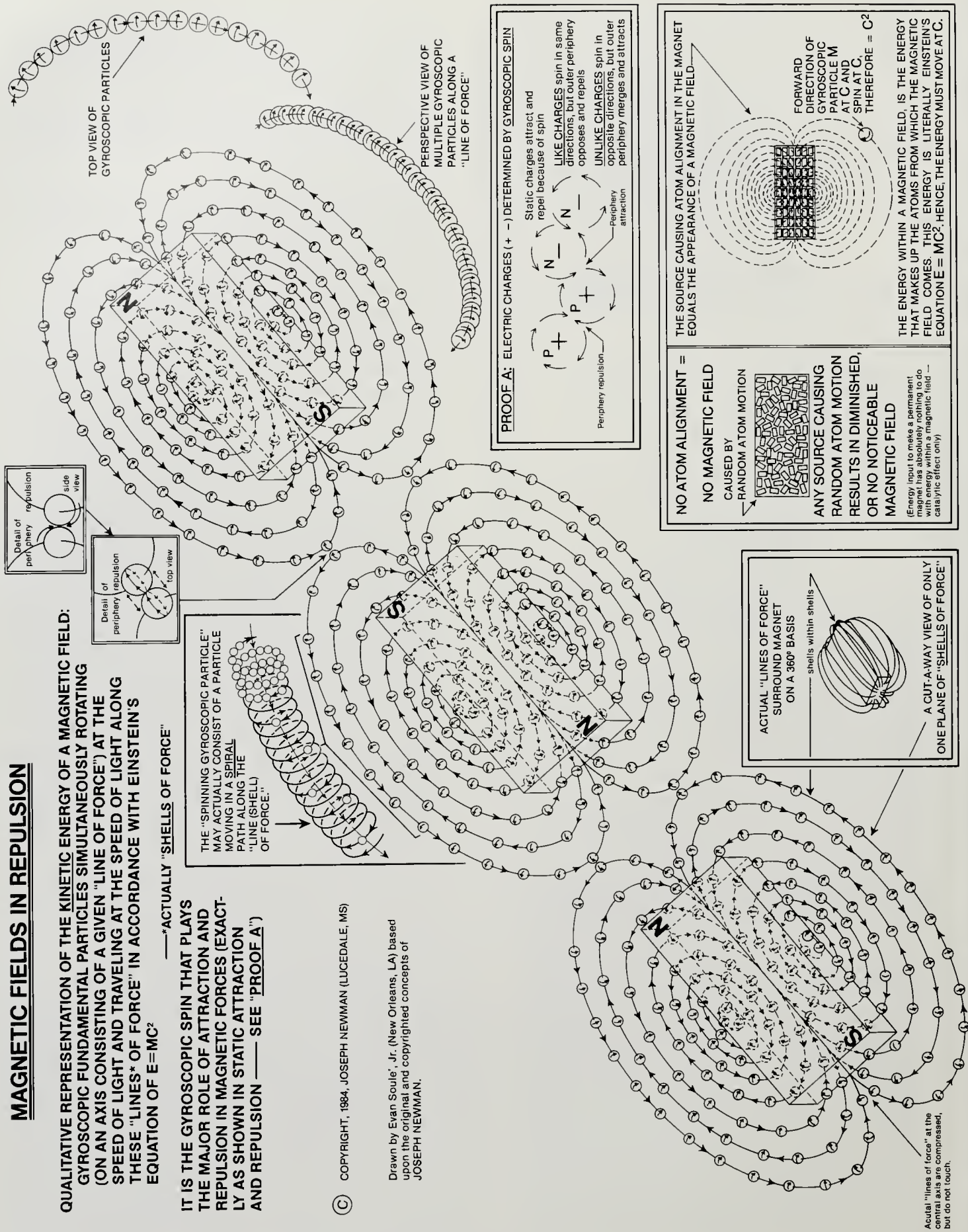

TOP VIEW OF GYROSCOPIC PARTICLES

PERSPECTIVE VIEW OF MULTIPLE GYROSCOPIC PARTICLES ALONG A "LINE OF FORCE"

THE "SPINNING GYROSCOPIC PARTICLE" MAY ACTUALLY CONSIST OF A PARTICLE MOVING IN A SPIRAL PATH ALONG THE "LINE (SHELL) OF FORCE."

PROOF A: ELECTRIC CHARGES (+ -) DETERMINED BY GYROSCOPIC SPIN
 Static charges attract, and repel because of spin
 LIKE CHARGES spin in same directions, but outer periphery opposes and repels
 UNLIKE CHARGES spin in opposite directions, but outer periphery merges and attracts

NO ATOM ALIGNMENT = NO MAGNETIC FIELD
 CAUSED BY RANDOM ATOM MOTION
 ANY SOURCE CAUSING RANDOM ATOM MOTION RESULTS IN DIMINISHED, OR NO NOTICEABLE MAGNETIC FIELD
 (Energy input to make a permanent magnet, or to give a substance energy within a magnetic field — catalytic effect only)

THE SOURCE CAUSING ATOM ALIGNMENT IN THE MAGNET EQUALS THE APPEARANCE OF A MAGNETIC FIELD.
 FORWARD DIRECTION OF GYROSCOPIC PARTICLE M AT C AND SPIN AT C, THEREFORE = C²
 THE ENERGY WITHIN A MAGNETIC FIELD, IS THE ENERGY THAT MAKES UP THE ATOMS FROM WHICH THE MAGNETIC FIELD COMES. THIS ENERGY IS LITERALLY EINSTEIN'S EQUATION $E = MC^2$. HENCE, THE ENERGY MUST MOVE AT C.

ACTUAL "LINES OF FORCE" SURROUND MAGNET ON A 360° BASIS
 shells within shells
 A CUT-AWAY VIEW OF ONLY ONE PLANE OF "SHELLS OF FORCE"

Actual "lines of force" at the central axis are compressed, but do not touch.

MAGNETIC FIELDS IN ATTRACTION

QUALITATIVE REPRESENTATION OF THE KINETIC ENERGY OF A MAGNETIC FIELD: GYROSCOPIC FUNDAMENTAL PARTICLES SIMULTANEOUSLY ROTATING (ON AN AXIS CONSISTING OF A GIVEN "LINE OF FORCE") AT THE SPEED OF LIGHT AND TRAVELING AT THE SPEED OF LIGHT ALONG THESE "LINES* OF FORCE" IN ACCORDANCE WITH EINSTEIN'S EQUATION OF $E=MC^2$

IT IS THE GYROSCOPIC SPIN THAT PLAYS THE MAJOR ROLE OF ATTRACTION AND REPULSION IN MAGNETIC FORCES (EXACTLY AS SHOWN IN STATIC ATTRACTION AND REPULSION — SEE "PROOF A")

© COPYRIGHT, 1984, JOSEPH NEWMAN (LUCEDALE, MS)

Drawn by Evan Soule, Jr. (New Orleans, LA) based upon the original and copyrighted concepts of JOSEPH NEWMAN.

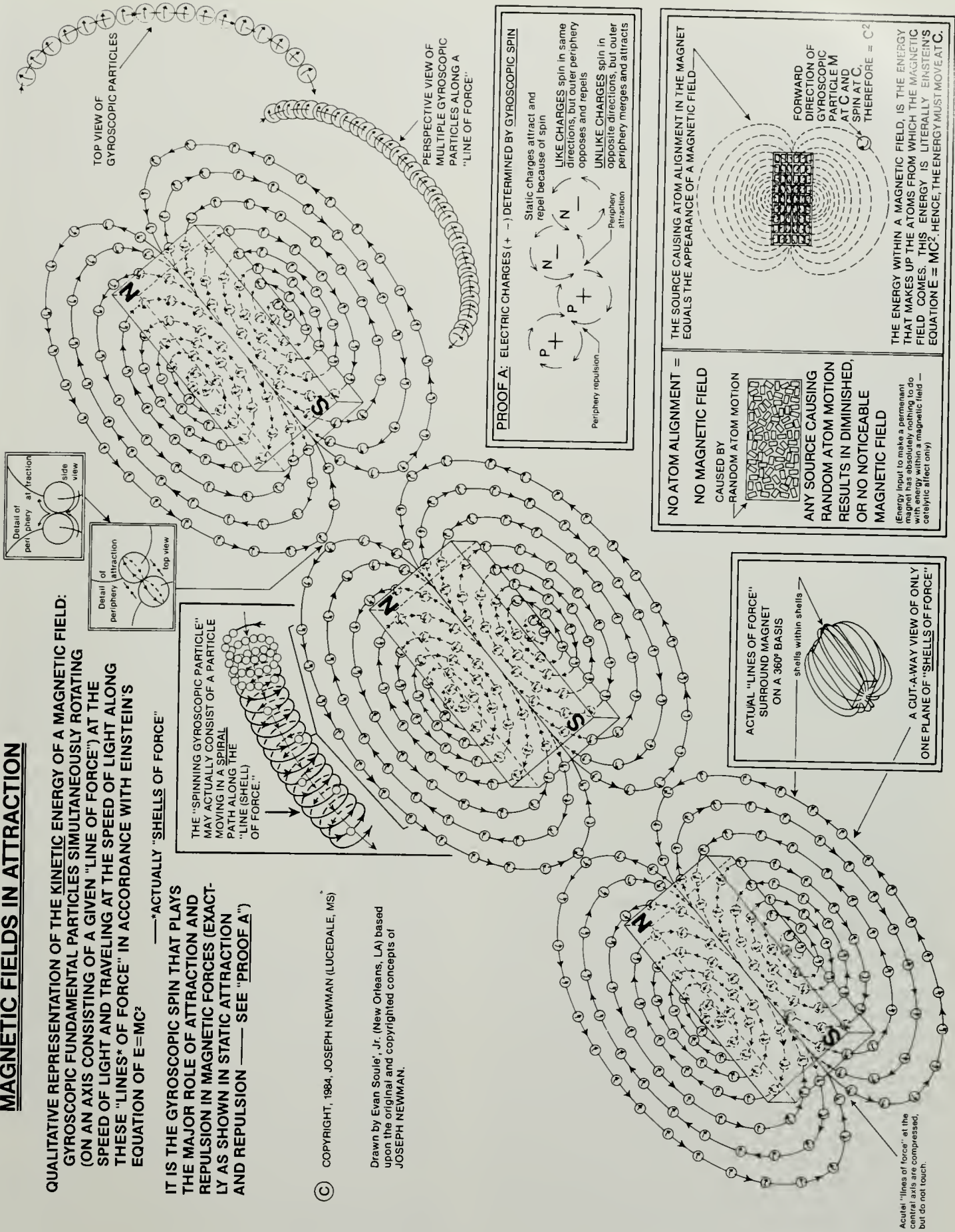

Detail of periphery attraction top view

Detail of periphery attraction side view

THE "SPINNING GYROSCOPIC PARTICLE" MAY ACTUALLY CONSIST OF A PARTICLE MOVING IN A SPIRAL PATH ALONG THE "LINE (SHELL) OF FORCE."

PROOF A: ELECTRIC CHARGES (+ -) DETERMINED BY GYROSCOPIC SPIN
 Static charges attract and repel because of spin
 LIKE CHARGES spin in same directions, but outer periphery opposes and repels
 UNLIKE CHARGES spin in opposite directions, but outer periphery merges and attracts

NO ATOM ALIGNMENT = NO MAGNETIC FIELD
 CAUSED BY RANDOM ATOM MOTION

ANY SOURCE CAUSING RANDOM ATOM MOTION RESULTS IN DIMINISHED, OR NO NOTICEABLE MAGNETIC FIELD

(Energy input to make a permanent magnet has absolutely nothing to do with energy within a magnetic field — catalytic affect only)

THE SOURCE CAUSING ATOM ALIGNMENT IN THE MAGNET EQUALS THE APPEARANCE OF A MAGNETIC FIELD

FORWARD DIRECTION OF GYROSCOPIC PARTICLE M AT C AND SPIN AT C THEREFORE = C^2

THE ENERGY WITHIN A MAGNETIC FIELD, IS THE ENERGY THAT MAKES UP THE ATOMS FROM WHICH THE MAGNETIC FIELD COMES. THIS ENERGY IS LITERALLY EINSTEIN'S EQUATION $E = MC^2$. HENCE, THE ENERGY MUST MOVE AT C.

ACTUAL "LINES OF FORCE" SURROUND MAGNET ON A 360° BASIS

shells within shells

A CUT-A-WAY VIEW OF ONLY ONE PLANE OF "SHELLS OF FORCE"

Actual "lines of force" at the central axis are compressed, but do not touch.

Chapter 3

TECHNICAL DESCRIPTION OF DRAWINGS

"... it is impossible for anyone to begin to learn what he thinks he already knows."

— Epictetus

Described above are the technical drawings for one aspect of Joseph Newman's theories. The two drawings — MAGNETIC FIELDS IN REPULSION and MAGNETIC FIELDS IN ATTRACTION — describe three bar magnets in a three-dimensional configuration surrounded and penetrated by circulating gyroscopic particles, each of which spins while traveling upon "lines (shells) of force (direction)" that consecutively alternate in opposite directions. [The difference between the two drawings is that the central magnet is reversed.]

According to Mr. Newman, these gyroscopic particles are the smallest particles known and comprise all atoms within the universe. The technical drawings are *qualitative* in nature; quantitatively, there are trillions of such gyroscopic particles flowing in the described paths to generate the magnetic field. Although sub-atomic particles will be shielded by lead, the effects of magnetic fields can be observed through lead shielding. According to Mr. Newman, this is one proof that these particles are the most fundamental particles known.

These drawings represent the *first* time in the history of physics that there is presented in an explicit pictorial fashion (via the concepts innovated by Mr. Newman) a precise, mechanical explanation of the phenomena of magnetism and the principle of "action at a distance." In his researches on magnetism, James Clerk Maxwell (as well as Michael Faraday) *explicitly* described the lines of force surrounding a magnet as *kinetic, mechanical energy*. (Maxwell called electromagnetism "matter in motion.") This description by Maxwell has been forgotten in the past 100 years. While Maxwell could not explain in detail the action of a magnet, he did recognize that such action *is* mechanical in nature.

As one passes a conductor wire in front of and across the end of a bar magnet, one will observe the current to flow first in one direction, then become neutral, then reverse itself and flow in the opposite direction. This occurs due to the nature of the flow of the gyroscopic particles as they flow from each end of the bar magnet (see drawings above). On one side of the south (S) end of the bar magnet, for instance, the particles flowing in and out along the "lines of force" spin "up," while on the other side of the *same* south end, the particles flowing in and out along the "lines of force" spin "down." A spinning gyroscope will move at right angles to the force acting upon it; hence, as the gyroscopic particles encounter the particles composing the conductor wire, they

move "up" or "down" the conductor (at right angles to the direction that they first encounter the conductor).

Mr. Newman indicates that it is principally the *spin* of the gyroscopic particle (and *not* the direction of flow for the gyroscopic particles along the "lines of force") that determines magnetic repulsion and attraction. The interaction of the peripheries of the particles actually effects such repulsion and attraction (see PROOF A). Although the drawings depict space between the particles flowing in a given "line of force," in actuality the particles are more like individual spirals upon a strand of beads in the shape of a helix which results in a gyroscopic action — each particle "bumping against the next." [According to Mr. Newman, between each particle there is a very small amount of space created by the electromagnetic force surrounding each particle.]

As the drawings depict, the actual "lines of force" are really *shells of force* which envelop the magnets as discrete shells of gyroscopic particles which lie concentrically within other shells. These "lines of force" (as depicted in one plane on the drawings) or shells of force (in actuality) travel (rotate) in opposite directions relative to one another. The effect of such motion is to place the peripheries of respective gyroscopic particles (from one "line of force" to the next) at opposition (or repulsion) to one another and consequently keep each "line of force" separated from each adjoining (concentric) "line (shell) of force."

In addition, there are as many "lines of force" emanating from each end of the bar magnet as there are atoms aligned magnetically across the width and height of the N and S ends of the magnet. Because of the large size of iron filings relative to the sub-atomic size of the gyroscopic particles, the particles within the "line of force" congeal clumps of the filings into (via the naked eye) a relatively few number of such lines. With more finely-ground iron filings, more "lines of force" would become visible to the human eye.

Each particle (M) travels along the "line (shell) of force" at the speed of light (C) and also individually spins at the speed of light (C). Consequently, such motion results in energy (E) since $E = MC^2$.

It should also be noted that, based on the theories of Mr. Newman, I constructed three-dimensional models of two bar magnets to study how the gyroscopic particles interact. Using simple styrofoam (for the bar magnet), wire (for the "lines of force"), and wooden beads (for

the gyroscopic particles), I was able to construct these models as shown in the technical drawings. (This is only an analogous construction. Mr. Newman does not state there is a solid particle spinning on its axis as it moves, but probably is a particle moving [in effect, spinning] in a circular [spiraling helix] configuration at the speed of light and moving forward at the speed of light [within the general helix action]; such combined motion equals C^2 .) (See Figure 13-G.)

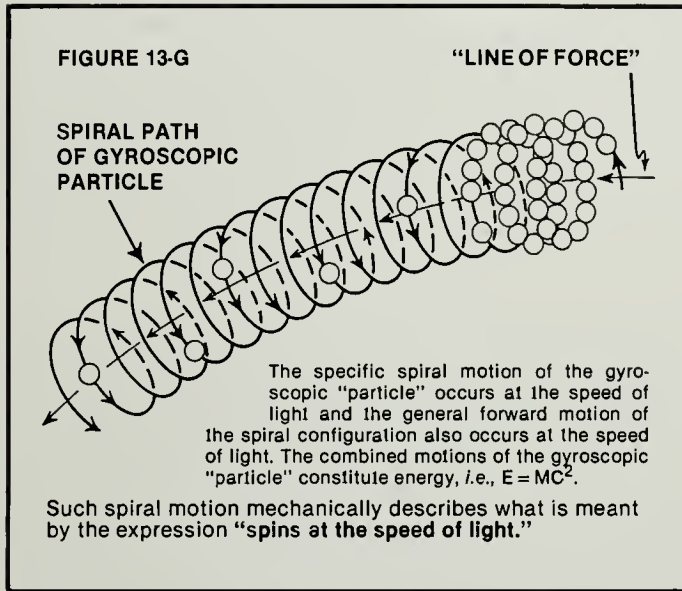

An interesting observation occurred following construction and study of these two models: while the N and S pole faces of two magnets (see Figure 13-H1) attract

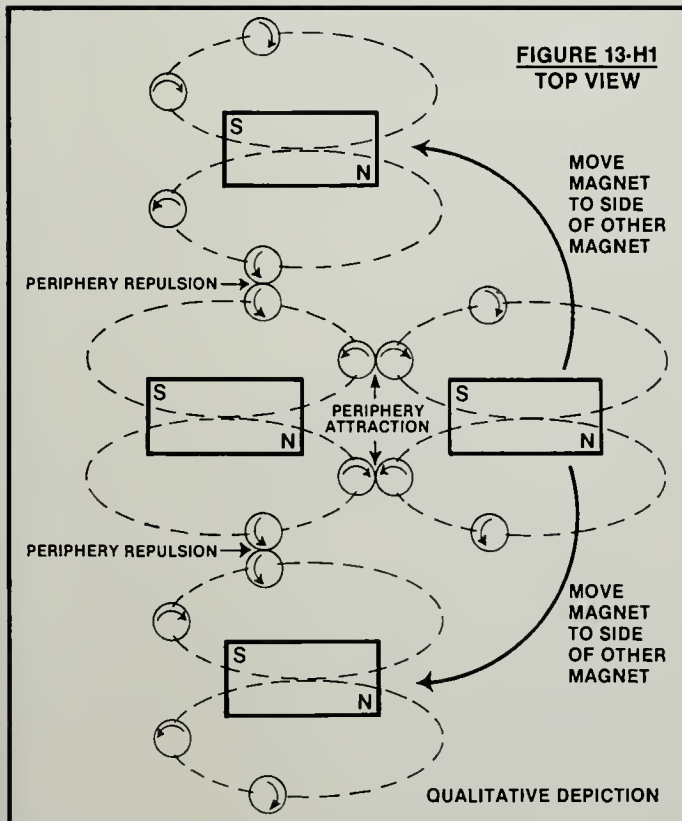

when placed directly *end-to-end*, if one shifts the same faces to the *side of one another* (keeping them in the same plane), one will notice that the periphery spin of the gyroscopic particles flowing from N and S will interact to *repel* one another, even though opposite poles normally attract one another in a *head on* position.

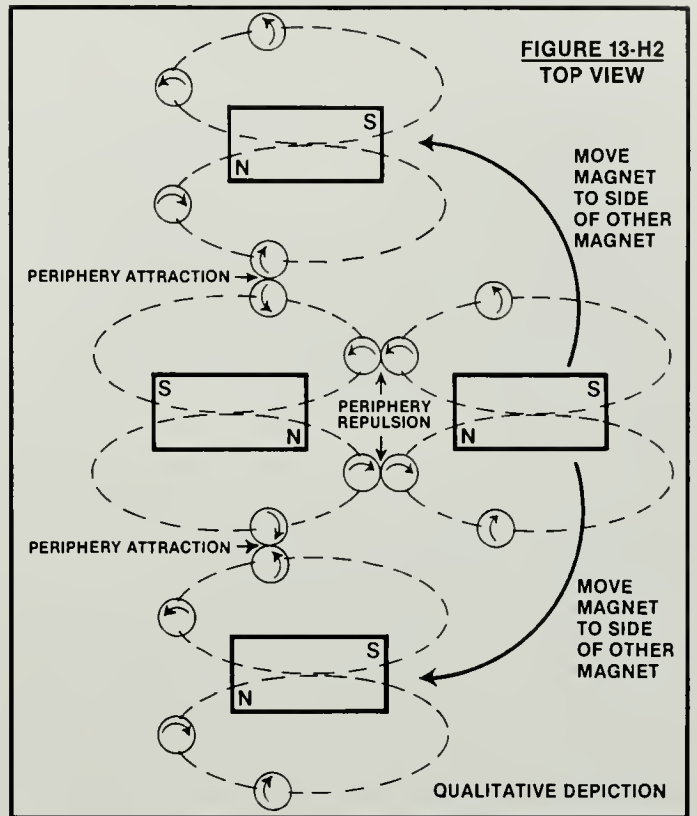

Similarly, with two like poles (see Figure 13-H2) brought together (N to N or S to S) — while they repel each other when placed *head on*, the models appeared to indicate that the magnets would attract each other when

This simple experiment to test the validity of an explanation for a previously unobserved (or if observed, then unexplained) magnetic phenomenon is a powerful corroboration for the rightness of Mr. Newman's theories.

the ends are placed slightly side to side (alongside one another and overlapping in the same plane.) For this writer, the *real test* was whether actual magnets behaved in this manner. In testing such magnets, I found that such *side* attraction (with N to N) and *side* repulsion (with N to S) was observed *exactly* as the mechanical descriptions of Mr. Newman would predict and indicate. This simple experiment to test the validity of an explanation for a previously unobserved (or if observed, then unexplained) magnetic phenomena is a powerful corroboration for the rightness of Mr. Newman's theories.

Technically speaking, like a water wheel harnessing the mechanical action of a river, Mr. Newman has effectively designed a machine capable of harnessing the above-described magnetic energy and converting it to useful electrical energy. Therefore, the produced electrical energy comes from the gyroscopic particles comprising the atoms of the magnet. A magnetic field is created (as the drawings indicate) when the atoms of a given material become aligned. According to Mr. Newman, the motion of the gyroscopic particles about the "lines (shells) of force" surrounding a magnet are a precise reflection of the interior, structural interaction of these particles within a given atom. The larger particles (quark, neutrino, meson, electron, proton, neutron, etc.) are various configurations and agglutinations of *the* gyroscopic particle. As the atoms become aligned within a magnet-to-be, they begin to act upon (and magnify) one another's individual, atomic, magnetic fields to integrate with one another until such fields completely mesh and expand to become the magnetic field of the complete magnet.

One may wonder that, if the magnets are depleted of their gyroscopic particles during the course of the operation of Mr. Newman's machine, will they not eventually lose their mass completely? The answer is yes, although because Mr. Newman's energy machine operates at 100% conversion efficiency (there being no radiation, heat, light, etc., as in nuclear fission reactions which operate at less than 1% efficiency), and because there are trillions plus gyroscopic particles within *each* atom, Mr. Newman estimates that it would literally be thousands of years before one would detect any significant, measurable amount of mass loss within a magnet.

It should be noted that Mr. Newman has worked on these ideas for 19 years. Mr. Newman submitted his theoretical discussion and proofs to the patent office several years *before* he constructed the actual working prototype of his energy machine. Mr. Newman was totally convinced of the rightness of his theories and did not need an operating machine to prove such rightness to himself. From his perspective, such a machine was needed as proof to everyone else.

It is Mr. Newman's position that from his various theories (of which this discussion about the [magnetic-field-creating] gyroscopic particles is only a *single* aspect of his theories) one should be able to understand that it would be possible to construct an energy machine that was capable of harnessing such (gyroscopic) energy if one could visualize the proper configuration of the materials necessary to effect such harnessing. Such configuration is the technical aspect of the Patent itself — technically independent of, but theoretically dependent upon, understanding the nature of the gyroscopic particles and how they interact with one another, especially since all atoms in the universe are composed of such particles.

Although this would be a separate (but physically-related) theoretical discussion, Mr. Newman has indicated that gravitation is the observed effect of the

interaction of unobserved electromagnetic fields (composed of gyroscopic particles) surrounding bodies in space. [Mr. Newman has theoretical concepts appropriate to this subject.]

As the drawings also indicate, positive and negative electrical charges are determined by the gyroscopic spin of individual particles, and such charges are repelled or attracted to one another according to periphery attraction (see PROOF A).

The fundamental, gyroscopic particle is, therefore, the unifying factor for the nuclear, electric, magnetic, and gravitational fields.

Evan R. Soule', Jr.
New Orleans, Louisiana (1984)

NOTE: To date, over thirty individuals have signed Affidavits attesting to the rightness of Mr. Newman's invention. These individuals include electrical engineers, physicists, inventors, scientists, and explicitly: Mr. Milton Everett (biomass energy specialist with the Mississippi Department of Energy), Dr. Roger Hastings (principal physicist for Sperry-Univac in St. Paul, Minnesota), and Mr. Eike Mueller (West German scientist and European Space Agency mission coordinator with the National Aeronautics and Space Administration).

Chapter 4

EXPLANATION FOR A WORKING INVENTION

"When a mathematician engaged in investigating physical actions and results has arrived at his own conclusions, may they not be expressed in common language as fully, clearly, and definitely as in mathematical formulae? If so, would it not be a great boon to such as well to express them so — translating them out of their hieroglyphics that we might also work upon them by experiment?"

— Michael Faraday to James Clark Maxwell, 1857

I will now present an explanation for a working invention which utilizes the energy within magnetic fields and produces more energy than is introduced into the system from an external energy input. Do not at this point reflect poorly upon yourself and blindly state "perpetual motion." Simply put, the technological process which I will discuss converts mass into energy on a 100% conversion process via $E = MC^2$.

14. I believe it is imperative to reiterate that the energy in any magnetic field is the energy which composes the elements of the atom and is literally Einstein's Equation of $E = MC^2$. Such energy in the form of gyroscopic particles is the basic building block of all matter and provides the basis for the conceptual interface between energy and matter.

The following facts will clearly demonstrate a fundamental understanding which prepares the reader for a more thorough comprehension of how one technological embodiment of this Pioneering Invention can be built.

14

A. The prior teachings indicate that copper is non-magnetic and that the resulting magnetic field associated with current flow in copper is the result of the current.

14

B. Those teachings are totally wrong. Copper is extremely magnetic! It is so magnetic that it deceives the observer. *Example:*

Turn the current on as in Figure 14-B1 and a magnetic field will occur very quickly. Then turn the current off as in Figure 14-B2 and the magnetic field very quickly disappears with no remnant of the magnetic field observed in the copper material. If one then places a magnet close to the copper, it is not observed to be noticeably magnetic. Therefore, one is easily deceived since conventional, *so-called* magnetic materials generate a different result. *Example:*

FIGURE 14-B3

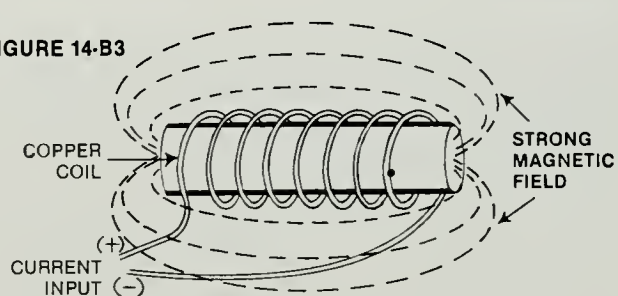

FIGURE 14-B4

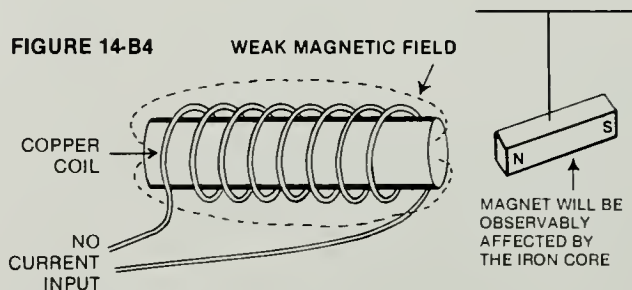

FIGURE 14-B1

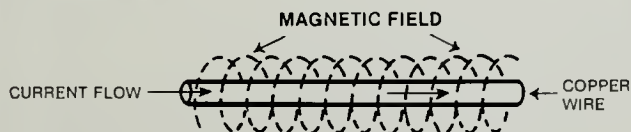
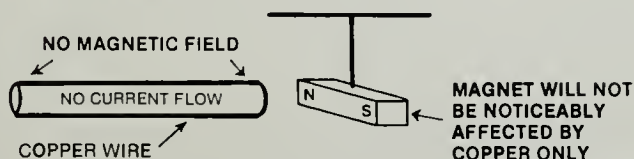

FIGURE 14-B2



By placing an iron core within a copper coil (as in Figure 14-B3) and turning the current on, a significantly stronger magnetic field will be generated than in Figure 14-B1 [for the same energy input]. Now, turn off the current as in Figure 14-B4 and there will be a small, remnant magnetic field surrounding the iron core. If a magnet is placed near the iron core, the magnet will be visibly affected. However, one is easily deceived by these tests and can be misled into believing that copper is non-magnetic. This is exactly what happened to Hans Christian Oersted in 1820 when he first discovered that an electric current produced a magnetic field which would cause a magnet to align at right angles to the conducting wire. Oersted noted that the deflection of the magnet lasted only as long as the current was flowing through the conducting wire and hence, such magnetic action could not be

caused by the (copper) wire, but must be a result of the current itself. This same incorrect conclusion is still rigidly taught to this day.

The following facts will clearly prove that copper is *highly magnetic* relative to the speed of atom alignment/unalignment as well as the action/reaction effect of the energy release (in the form of the gyroscopic particles previously discussed) from the atoms comprising the copper wire!

“The prior teachings indicate that copper is non-magnetic and that the resulting magnetic field associated with current flow in copper is the result of the current. Those teachings are totally wrong. Copper is extremely magnetic! It is so magnetic that it deceives the observer.”

¹⁴ C. What the Prior Art teaches: Hypothetically, if one imposes current into a (copper*) conductor coil of pure inductance, the same current would be returned as that which was initially placed into the (copper*) conducting coil. (See Figures 14-C1 and 14-C2.)

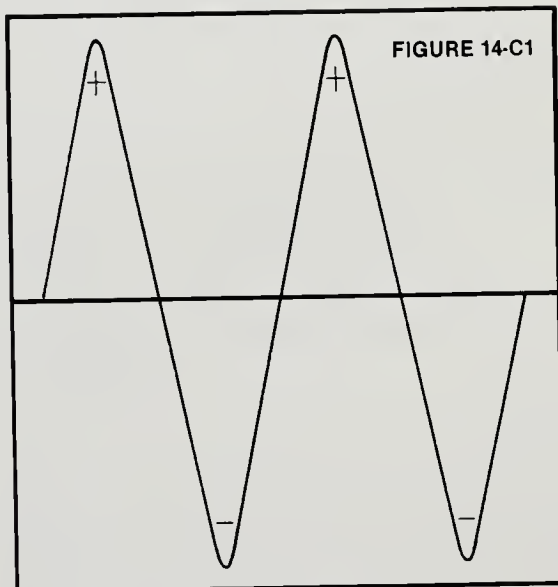

FIGURE 14-C1

GRAPH POWER IN PURE INDUCTANCE

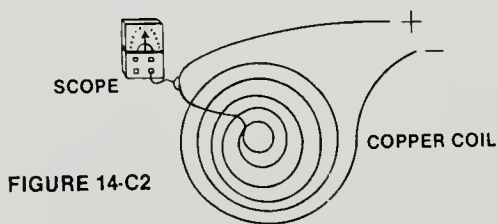

FIGURE 14-C2

[*This process is in no way limited to copper. Actually, one can utilize *any* suitable materials for conducting, e.g., super-conducting materials such as niobium tin, etc.]

Physically speaking, this simply means that the energy contained within the magnetic field — when generated by positive (+) current flow in one direction — is returned by the collapsing magnetic field as negative (-) current flow when the current flow reverses direction.

¹⁴ D. The Prior Art also teaches Kirchhoff's Law which states: the same amount of current placed into a system (as a copper conductor) for a given-instant of time has the same amount of current flowing from that system (copper conductor) for the same given-instant of time. (See Figure 14-D.)

FIGURE 14-D

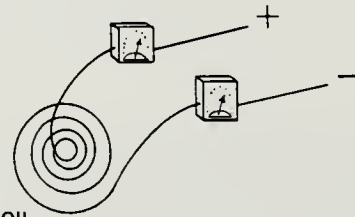

COPPER COIL

METERS SHOW SAME CURRENT OUT OF COIL AS CURRENT INTO COIL IN THE SAME INSTANT OF TIME

¹⁴ E. The above FACTS of 14C and 14D totally contradict the prior teaching that the magnetic field generated by the current flowing in a (copper) conductor is solely a result of the current itself and that copper is non-magnetic.

Look at the facts and open your mind!

The facts demonstrate the following: 14C above shows that if one inputs a given amount of current (X) into a copper coil during a given-instant of time then, as described in 14D above, the same amount of current (X) outputs from the copper coil during the same instant of time. In addition, 14C above also shows that if the current is then *cut off* and the coil shorted with meters in the line, then the same amount of current (X) will *now come from the copper coil*.

The facts therefore demonstrate: (X) current in and (X) current out *plus* (X) current out again when the (X) current input is stopped. These facts are therefore equivalent to 1 (X) amount of current *into* the coil (copper) and 2 (X) amount of current *out of* the (copper) coil.

QUESTION: *From where did the extra (X) amount of current coming from the copper coil emanate?*

ANSWER: By analogy, the Prior Teachings indicate that current is equivalent to the volume of water and that

voltage is equivalent to the pressure of water. Therefore, one should understand the essence of this analogy relative to the facts discussed above. (See Figures 14-E1 and 14-E2.)

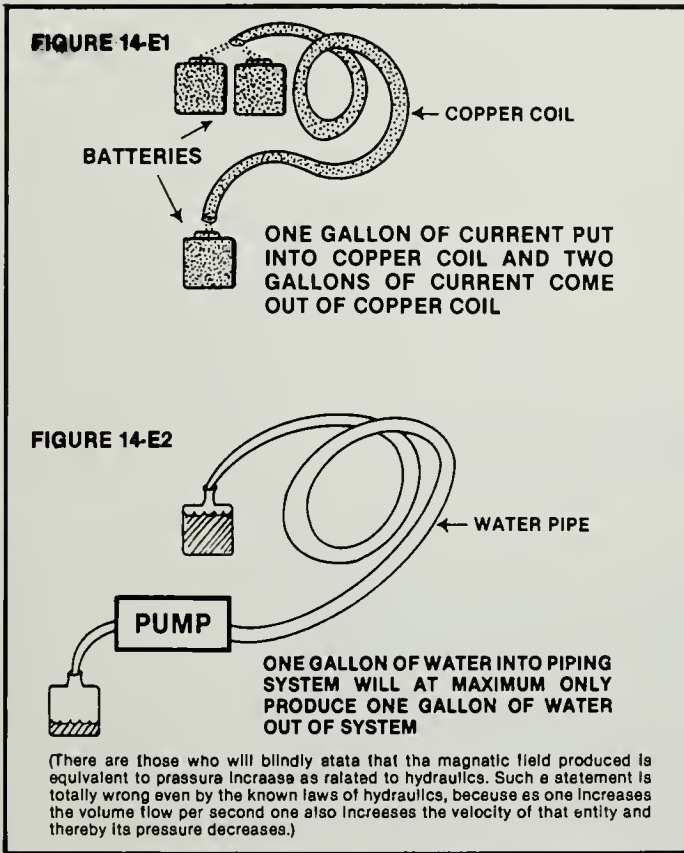

The facts clearly demonstrate that in Figure 14-E1, one "gallon" of current came from the copper coil itself and most definitely not from the initial one "gallon" of current put into the copper coil. (This is an analogy only. The mass or volume of the electric current input or output cannot be seen or weighed because it is composed of gyroscopic particles and is the mechanical essence of $E = MC^2$.)

¹⁴ F. The Prior Teachings distort the above facts and would indicate that the analogy of one "gallon" of current has no pressure when coming from the coil in Figure 14-E1, and that one "gallon" of current has a pressure which is thereby equivalent to one "gallon" of current with the input pressure. Furthermore, such teachings would indicate that because of the resistance within the coil and other losses, not even the latter pressure will occur in reality.

Even I was misled by these teachings for many years, and I finally came to the realization that copper was highly magnetic by a completely different means than outlined above. These means included: (1) my general comprehension which originated with my recognition that the basic building block of all matter was the *gyroscopic particle*, and (2) a test I conducted using a single piece of copper wire 800 feet long, which was doubled-back 400 feet to the

starting point and hooked to a meter and dry cell battery. (See Figures 14-F1 and 14-F2.)

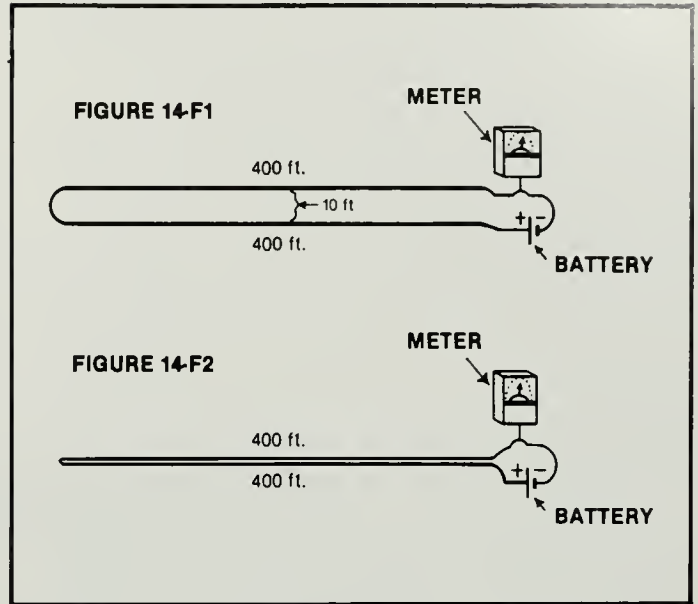

The test shown in Figure 14-F1 has the parallel positions of the wire 10 feet apart, with no "Unobvious Force" between the parallel portions of the wire. The test shown in Figure 14-F2 has the parallel portions of the wire extremely close, with an "Unobvious Force" between the parallel parts of the single wire.

The results of these two tests demonstrated the same current input for both tests. Prior to these results I had recognized that the words "Work," "Force," and "Power" are implicit engineering statements and do not represent precise, scientific terms based upon observational reality. I conceptually altered such macroscopic, engineering statements to "Obvious work," "Obvious Force," and "Obvious Power." I would microscopically describe what occurs internally, within matter as "Unobvious Work," "Unobvious Force," and "Unobvious Power." (I will explain these concepts later in this Book.) Such semantic clarification enabled me to know — upon completing the above tests in Figures 14-F1 and 14-F2 — that copper is extremely magnetic.

¹⁴ G. Returning to the above test of Figure 14-E1 and 14-E2: by my teaching, the facts clearly show that in the above analogy, one gallon of current "matter" (consisting of gyroscopic particles) was released from the atoms of the copper coil! This extra one gallon of current (gyroscopic particles) comes from the component parts of the atoms comprising the copper coil and simply utilizes Einstein's Equation of $E = MC^2$. (I must stress that this is an analogy only. The volume or mass of matter via the gyroscopic particles represents the mechanics of $E = MC^2$ and such particles cannot be seen or weighed by conventional means. Their existence can be inferred, however, based on their mechanical behavior combined with known, observational facts.)

QUESTION: How can this *extra* one gallon of current exist?

ANSWER: The current input (gyroscopic particles) simply *acts as a catalyst* relative to the atoms comprising the copper coil — atoms which align and unalign extremely fast compared to the atoms of conventional, magnetic materials — thereby releasing virtually immeasurable portions of the gyroscopic particles comprising the atoms of the coil. This release generates the magnetic field. When the input current is turned off, the collapsing (gyroscopic particles of the) magnetic field within the coil results in the gyroscopic particles attempting to return to the atoms from which they initially emanated. Such mechanical action results in the gyroscopic particles striking other atoms within the copper coil at some degree of a right angle and moving *at right angles to that force*. This gyroscopic mo-

“Such mechanical action results in the gyroscopic particles striking other atoms within the copper coil at some degree of a right angle and moving at right angles to that force.”

tion explains the source for the additional “one gallon” of current (gyroscopic particles) discussed in the above water analogy. Because of the “conversion efficiency” of this process via $E = MC^2$, there will be *no* observable change in the mass of the copper coil even after decades of use.

I should add that there is an important conceptual distinction between two meanings of the word “efficiency.” To state that a given invention is 8.2 efficient, *i.e.*, it produces over eight times as much energy as it consumes, is different from stating that the invention is 100 percent efficient, *i.e.*, it completely converts the gyroscopic particles within the magnet from “magnet mass” to electrical energy. The former process involves *production* efficiency and the latter process involves *conversion* efficiency.

15. Now to discuss the practical usage for this new understanding of the gyroscopic particles which are the mechanical essence of the equation $E = MC^2$ and comprise the component parts of the atoms within all matter, conductors, and copper. By understanding the teachings (of this Pioneering Invention), one can build a physical embodiment of this Pioneering Invention by using a conducting coil which will produce more energy out of the system than that put into the system from an outside source such as battery, generator, etc.

I wish to thank Dr. Roger Hastings, Senior Physicist for Sperry-Univac, for calculating by conventional mathematics the quantitative measurements for the following test which I had proposed. Dr. Hastings is an exceptional scientist who had the character to come forth in my behalf when many others were fearful or close-minded.

For “mind-opening purposes” (to use the current vernacular) carefully study the following two tests:

15

A. Take 40-gauge copper wire which has a resistance of 1,049 Ohms for 1000 feet with a total weight (of atoms composed of gyroscopic particles) of a mere .02993 lbs., turning same into a coil with a 10-foot interior diameter and 8.32 feet in height. One would therefore have approximately a mere 31.8 turns of copper wire (copper atoms, *i.e.*, gyroscopic particles). (See Figure 15-A.)

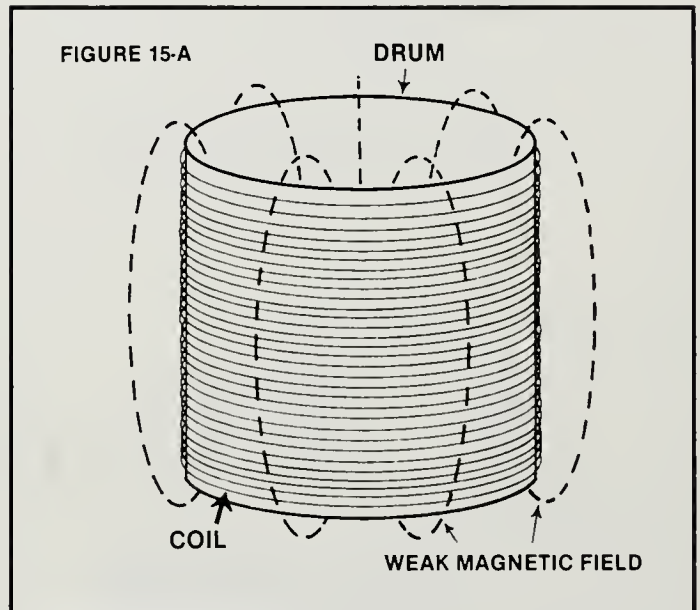

If 100 volts is connected to coil 15-A, then a current flow of approximately 95MA would occur with total power input of 9.5 watts and a resulting weak, magnetic field of .012 Gauss or a mere .000014 Joules of energy stored in this weak, magnetic field.

An insignificant current flow would now occur if the current input was stopped and coil 15-A was shorted-out to collapse a weak magnetic field and provide an inductance of only .003 Henries.

15

B. Now, conduct another test with 5-gauge copper wire which has a resistance of .3133 Ohms for 1000 feet. However, to equal the same resistance as in 15-A above, one must now use 3,348,000 feet of 5-gauge wire with a massive, total weight (of atoms composed of gyroscopic particles moving and traveling at the speed of light, *i.e.*, the mechanical essence of Einstein's Equation $E = MC^2$) of 335,469.6 lbs. or 16.77 tons. Such wire is turned into a coil with a 10-foot interior diameter and 8.32-foot height. This structure would have approximately a phenomenal 90,000 turns of 5-gauge (copper atoms). If 100 volts were now connected to coil 15-B (see drawing below), then a current flow of approximately 95MA could occur with a total power input of 9.5 watts and a resulting, phenomenally larger magnetic field of 23.7 Gauss, or 1,905 times larger for coil 15-B than for coil 15-A, and 116 Joules of energy stored in the magnetic field of Figure 15-B below. This represents a phenomenal 8 million times more energy than in the 40-gauge coil of 15-A above.

FIGURE 15-B

PHENOMENALLY STRONGER MAGNETIC FIELD

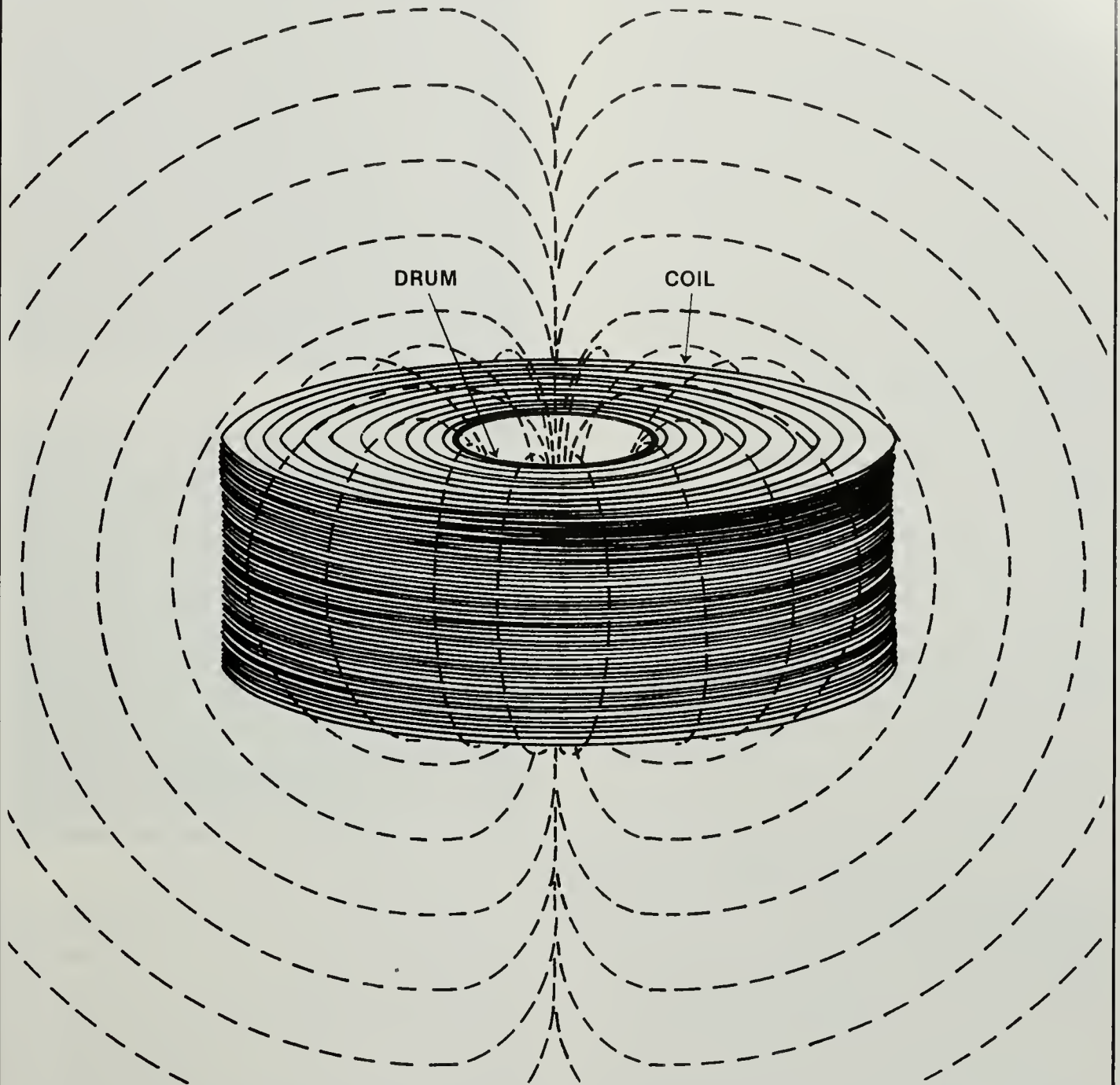

A phenomenally larger current flow would now occur if the current input was stopped and coil 15-B was shorted-out as a result of the collapsing, much greater magnetic field of the 5-gauge wire in coil 15-B. Such shorting would generate an inductance of 25,700 Henries, which is better than *8 million times the inductance of the 40-gauge coil in Figure 15-A above.*

Clearly, these facts — combined with the above FACTS 1 through 14 — prove beyond any doubt that Oersted's conclusion in 1820 (which is still taught to

this day): "that the magnetic field came only from the current and not the conductor" to be totally false. [Although his conclusion is incorrect, I remain grateful to Hans Christian Oersted for being the first to notice and attempt to explain an observed connection between an electric current and a magnetic field.]

When coupled with FACTS 1 through 14, tests 15-A and 15-B clearly prove that the phenomenal difference in strength for the resulting magnetic fields (implying great differences in stored energy) and additional current flow when the input current was stopped (induc-

tance), had to come from the gyroscopic particles comprising the component parts of the atoms within the copper coil.

*The current flow input was the same in both tests, but the number of atoms (lbs. of copper) varied considerably from test 15-A to test 15-B correlating precisely with the phenomenal difference in the strength of magnetic fields produced, the extreme difference in the stored energy (gyroscopic particles), and the great difference (inductance) in the additional current flow produced when the input current was stopped in test 15-A and test 15-B. These phenomenal differences represent the mechanical essence of $E = MC^2$: **gyroscopic particles.***

All of the above FACTS 1 through 15 scientifically establish the position that the mathematical formulas employed in the calculation of the energy within a magnetic field (intended to represent the potential energy or stored energy of Joules in a magnetic field) are totally incorrect. The FACTS above clearly indicate that the magnetic field consists of *gyroscopic-type particles* which are the mechanical essence of $E = MC^2$ and represent an orderly flow of kinetic energy.

I will go further and state that "potential" energy, as such, does not exist! All energy is *kinetic* in nature, since the gyroscopic particles continue, under all conditions, to move and spin at the speed of light in accordance with $E = MC^2$.

The above FACTS prove beyond question that the proper mathematical equation (concerning the "kinetic" energy which makes up a magnetic field) must be relative to $E = MC^2$. A proper mathematical equation would recognize that the "Unobvious Force" produced represents the Joules of the "Unobvious Power" activated at that instant-in-time and as so used would diminish the mass of the source of the

Maxwell explicitly stated his debt to Faraday:

*"The methods are generally those suggested by the processes of reasoning which are found in the researches of Faraday, and which, though they have been interpreted mathematically by Prof. Thomson and others, are very generally supposed to be on an indefinite and unmathematical character, when compared with those employed by the professed mathematicians. By the method which I adopt, I hope to render it evident that I am not attempting to establish any physical theory of a science in which I have hardly made a single experiment, and that the limit of my design is to shew how, by a strict application of the ideas and methods of Faraday, the connexion of the very different orders of phenomena which he has discovered may be clearly placed before the mathematical mind." **

¹⁵
C. In 1979, I filed a patent for this Pioneering Invention of which several embodiments have been taught and disclosed since that time. The use of a conducting coil is one of those embodiments and the original patent and continuing patent applications were filed before *any* physical prototypes based on the Theory were built. The physical prototypes were thereafter built for the benefit of others, not for myself, since I knew such prototypes would operate as I had predicted. Scientifically, one should find pertinent the fact that when these prototypes were constructed, they performed *exactly* as I had conceptually predicted in the patent applications for this Pioneering Invention.

See below picture 15-C1 featuring one of these early prototypes utilizing 5-gauge, insulated copper wire with a total weight of approximately 4,200 lbs. of copper atoms (or over two tons), 300 lbs. of No. 30

"... the magnetic field consists of gyroscopic-type particles which are the mechanical essence of $E = MC^2$ and represent an orderly flow of kinetic energy."

magnetic field via a 100% utilization (*conversion* efficiency) of Einstein's Equation $E = MC^2$, since the magnetic field consists of kinetic energy having a gyroscopic action which represents the mechanical essence of $E = MC^2$.

I leave the task of determining the nature of such equations to a thinking, questioning mathematical mind, as I do not have the mathematical expertise. It should be noted, however, that the mechanical comprehension of a natural phenomenon has often historically preceded a mathematical model. James Clerk Maxwell acknowledged the importance of Michael Faraday's mechanical and experimental abilities. Maxwell also recognized that such mechanical aptitude constituted a major intellectual input to his later mathematical theories. In his paper 'On Faraday's Lines of Force,' read before the Cambridge Philosophical Society on December 10, 1855 and February 11, 1856,

Gauge copper wire (atoms) wrapped over the outside of the 5-gauge wire (atoms), and a permanent magnet containing approximately 600 lbs. of atoms (or slightly less than $\frac{1}{3}$ of a ton). [I am deliberately referring to the wire as "atoms" and describing the magnet as 600 lbs. of "atoms" in order to accustom the reader to a mechanical perspective concerning the nature of the action of the gyroscopic particles contained within all atoms.]

The massive, permanent magnet had an approximate 20-inch diameter and was slightly less than 4 feet long. The large, conducting copper coil had an approximate I.D of 4 feet, was approximately 3 feet in height, and was wrapped upon a large fiberglass tube. The total weight of the system was approximately 5,000 lbs.

*L. Pearce Williams, *Michael Faraday*, Chapman and Hall, Ltd. London, 1965, pages 510-511.



PHOTO 15-C1 (SIDE VIEW)

PHOTO BY MATT ANDERSON



PHOTO 15-C1 (TOP VIEW)

PHOTO BY MATT ANDERSON

The photographs shown in 15-C1 simply represent a primitive, handmade prototype made (in the backwoods of Lucedale, Mississippi, by me and my lovely, devoted wife) to prove to others that the Technical (Theoretical) Process which I originally developed and taught is correct. *I consider the Technical Process to be 10,000 times more important than the primitive, working prototypes.*

With only 1 ½ watts input, the back power (emf) produced would generate a spark at the commutator of such heat magnitude that the back power would, in a short period of time, explode and destroy a ceramic insulator from a 5-watt resistor placed on the commutator at the point of current reversal. Dr. Roger Hastings estimated the back emf to be in excess of 80,000 watts.

The rotating, handmade, 600 lb. (of atoms), 4-foot magnet permitted a slow RPM. At 200 RPM it was calculated by others that the centrifugal force would be 10,000 lbs. of force attempting to pull the magnet apart.

Everyone who initially viewed the massive unit in 15-C1 above was then asked the question: "Based on your expertise, how much power would be necessary to simply operate this device mechanically?" Answer: from 200 to 1000 watts. Other skilled individuals — upon learning that the unit had only copper in the coil — stated that in their expert opinion, the unit would be highly inefficient since it contained no iron core.

However, the facts pertaining to the unit's operation in 15-C1 do clearly prove that the unit could operate on *less than 1 ½ watts and that it was phenomenally efficient, i.e., far in excess of 100% production efficiency* relative to the power out of the system compared to the external power into the system, and exactly 100% *conversion efficiency* relative to the conversion of the mass (gyroscopic particles) of copper atoms to electrical and rotational energy output.

I must stress that this process is not "perpetual motion." Anyone who follows my teachings is simply

"The energy out of the total system is equivalent to the small amount of electrical energy input (acting as a pure catalyst) plus the extant magnetic energy (in the form of gyroscopic particles) within the system."

converting (on a 100% *conversion efficiency* basis) mass into energy via a 100% (or more) *production efficiency* process. *Therefore, the energy out of the total system is equivalent to the small amount of electrical energy input (acting as a pure catalyst) plus the extant magnetic energy (in the form of gyroscopic particles) within the system.* Due to this latter combination of energies, it may be said that the external energy output is greater than the external energy input.

I will again turn to Dr. Roger Hastings (Senior Physicist with Sperry-Univac) who has conducted more tests on different occasions upon my working prototypes than anyone else. I reemphasize the point that Dr. Hastings is an exceptional scientist who has courage and the true scientific attitude. As a result, he came forth in my behalf when many others were frightened or closeminded.

The verification of the operation of the unit in 15-C1 above, as well as other prototypes, and the qualitative scientific ability and fortitude of Dr. Hastings are clearly demonstrated via the test described in Chapter Five. Such a healthy, scientific attitude is even more exemplified by the fact that Dr. Hastings went on record as having once had the attitude that, before he traveled to Lucedale to meet me, to listen to my concepts, and to conduct tests, he was of the belief that he would be confronting a "crack-pot inventor." Fortunately, Dr. Hastings' skepticism was tempered with genuine curiosity. I have discovered that without such curiosity, skepticism will rapidly decay into cynicism.

Dr. Roger Hastings' statements and tests follow.

Chapter 5

DECLARATION BY DR. ROGER HASTINGS

FOLLOWING EXTENSIVE TESTING ON 5,000 AND 900 LB. UNITS

DECLARATION

The Honorable Commissioner
of Patents and Trademarks
Washington, D. C. 20231

Gentlemen:

This letter represents a disclosure of investigations and experimentation which I have performed on Mr. Joseph Newman's energy generating machine (patent pending). The fact is that every experiment which I have performed shows that the energy output of the device is indeed larger than the energy input. Some examples are:

1.) The electrical energy output is measured at more than four times the electrical energy input. These results may be verified by examining the oscillograph records taken by Dr. F. Neff Weber in December, 1981.

2.) Acting as a motor Mr. Newman's device performed mechanical work in excess of ten times the electrical energy input.

3.) Mr. Newman's device delivers over ten times the torque of a commercial D.C. permanent magnet motor rated at 80% efficiency. However, during this test Mr. Newman's device is consuming only a fraction of the input power of the commercial motor.

These results must be taken seriously. Mr. Newman has made the observation that huge magnetic fields may be generated with minimal power input in a large coil wound with large diameter wire. This coil creates a very large torque on a suitably large permanent magnet. In operation, the batteries powering the coil consume little power and discharge at a very slow rate. Yet the motor delivers considerable mechanical and/or electrically generated power.

It is fascinating to observe that Mr. Newman has arrived at this invention on the basis of his theoretical work, coupled with years of experimentation on electromagnetic energy. The fact that Mr. Newman is self-taught, with no formal training in advanced mathematics or physics, is apparent in his writings. Yet he has been rigorously consistent in development of a model of matter and energy, and furthermore has fortified his model with experimentation. His model is based on the assumption that matter is concentrated electromagnetic energy. He predicts that this energy ($E=MC^2$) may be released in a controlled way, and his experiments verify the prediction.

In view of the benefit Mr. Newman's device could bring to mankind, I urge you to take his patent application seriously, and not to be prejudiced by the style or claims of his writings. The patent application is in order and the stated results have been verified by experts. The burden is now upon you to act, either by issuing the patent immediately, or by first conducting your own measurements on his device to verify the claim.

The future of the human race may be dramatically uplifted by the large scale commercial development of this invention. It is indeed painful to see it lying dormant.

In hope that you will act soon,

Yours sincerely,

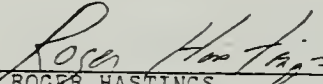
DR. ROGER HASTINGS
Principal Physicist
Sperry Univac Corporation
Former Associate Professor of Physics
North Dakota State University
Author of Scientific Literature

Waiver: I am acting on my own,
and am in no way representing
Sperry Univac Corporation.

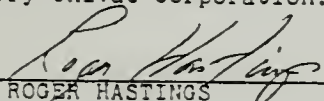
DR. ROGER HASTINGS

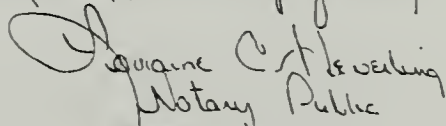
Subscribed and sworn to
February 21, 1982 State of
Mississippi, County of Itasca

Notary Public
My Comm. ...

April 26, 1982

A PERFORMANCE ANALYSIS OF THE NEWMAN MOTOR

This document compiles and analyzes the results of several experiments performed on the Newman Motor in 1981 and 82. The results of the experimental work show that this motor operates with energy output far in excess of energy input. This work is intended to characterize the motor, and to organize the experimental results. It is hoped that the document will serve as a guide in the development of the mathematical theory which explains the Newman Motor.

I. Mechanical Energy Output

A.) Test against a d.c. Permanent Magnet Motor/Rated 80% Efficient.

Date: 2-20-82

In this experiment eight fresh 1.5 Volt alkaline batteries were connected to an 80% rated efficient d.c. motor. The motor turned an oil pump at about 1 Hz. The motor ran for 6 minutes, and the final battery voltage was about 60% of the starting voltage.

Alkaline batteries were used because battery performance curves were available from the manufacturer. One such chart is plotted in Fig. 1. The performance of the d.c. motor is verified by the chart, which predicts that the batteries, when initially drained at 2 amps, will last 6 min. The measured motor drain under load was near 2 amps.

The above results allow us to estimate the power consumed by the oil pump. We find:

$$\frac{\text{initial pump output power}}{\text{initial battery input power}} = 0.8$$

$$\text{pump output} = 0.8 \times 2 \text{ amps} \times 12 \text{ volts} = 19 \text{ Watts}$$

The same pump was connected to the Newman Motor (with a 90# permanent magnet rotor) so that the pump again ran at near 1 Hz. Therefore, the pump was consuming the same power in this experiment. Eight fresh batteries were connected to the Newman Motor. (Unit designed as instructed in Patent Application, Serial No. 179,474, illustrated in Fig. 6 and stated in 1st three paragraphs of page 3 of Declaration by Joseph Westley Newman of September 19, 1981.) The batteries

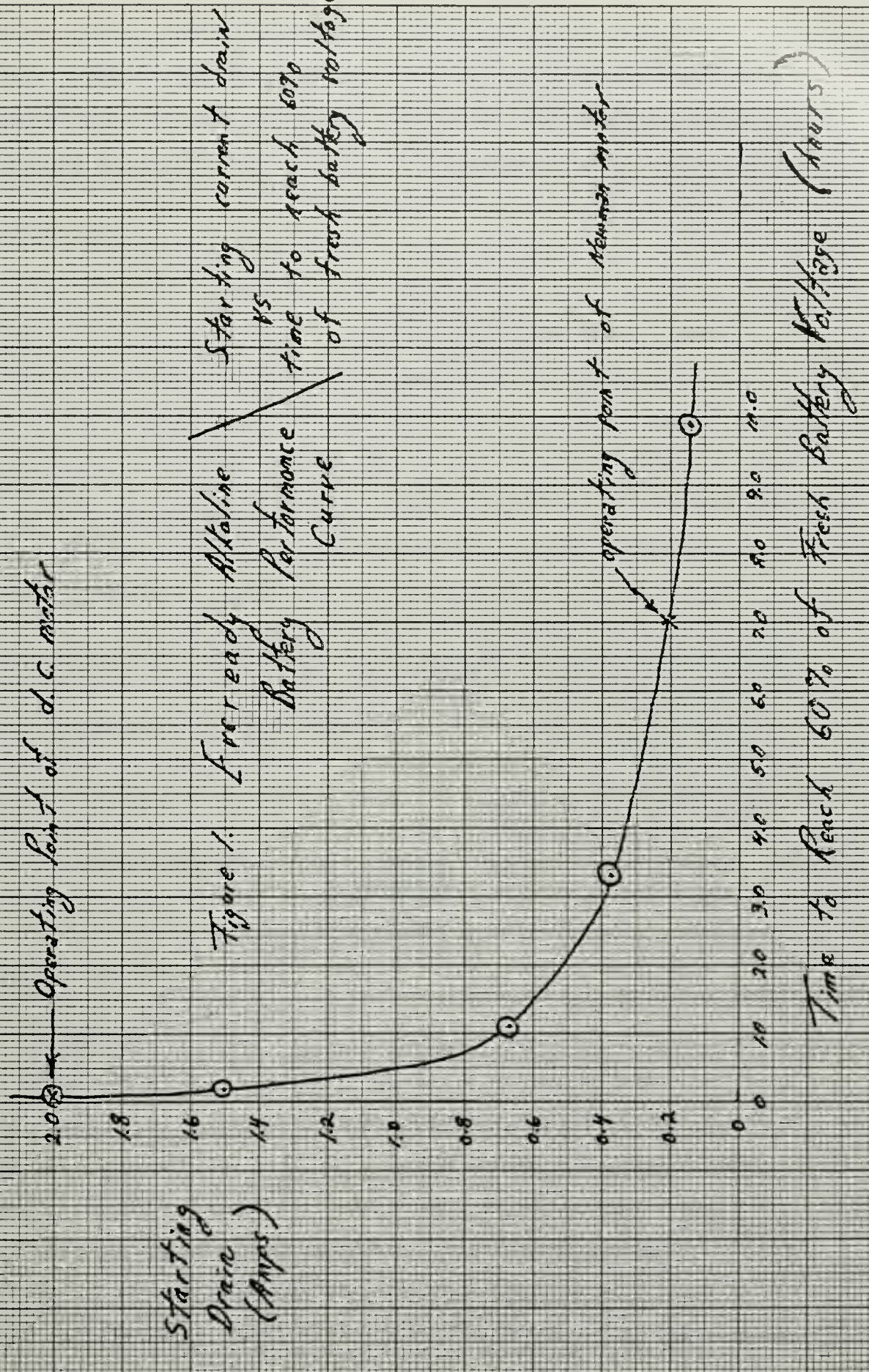

were drained to about 60% of their starting voltage after seven (7) hours! Although the input current to the Newman Motor follows a complicated waveform, we may estimate the initial average input current from the performance curve (fig. 1). Using 0.2 amps at 12 volts we find:

Initial Newman Motor Input = 2.4 Watts

Since the output is consuming 19 Watts we have:

$$\text{Newman Motor Efficiency} = \frac{19}{2.4} \times 100\% = 800\%$$

At this point we note that the intrinsic efficiency of the Newman Motor could be greatly increased. As designed now the motor has a tremendous leakage flux, and extreme mechanical losses. An efficiently designed Newman Motor would certainly have three times the efficiency quoted above, and perhaps ten times (8000%!).

B.) Static Torque Test

Date: 2-20-82

The output shafts of the d.c. motor and Newman Motor were connected in turn to a scale via a pulley and belt. The d.c. motor pulled a maximum of 1.5 lbs., while the Newman motor pulled 13 lbs. At maximum load the d.c. motor consumed about 24 Watts while the Newman Motor consumed only 2.4 Watts.

$$\text{Static Torque Ratio} \quad \frac{\text{Newman motor}}{\text{d.c. motor}} = \frac{13}{1.5} = 8.7$$

$$\text{@ input energy ratio} \quad \frac{\text{Newman Power}}{\text{d.c. motor power}} = 0.1$$

If we define a motor performance parameter under static loads by the ratio of maximum torque output to the input energy drain, we find that this number is 87 times larger for the Newman motor than for the d.c. permanent magnet motor!

C.) Battery Lifetime Tests

March/April, 1982

It has become apparent that the batteries powering the Newman motor outlive the expectations of the manufacturer. In this test 124 old alkaline batteries were used to power the (90 lb. rotor) motor. The batteries read 2/3 of their fresh voltage value at the outset of the experiment. It was found that the 90 lb. cylindrical

rotor is spun up to 6 Hz. in 21 sec. when the batteries are connected to the motor. The voltage drops from 125 V. to 70 V. when the batteries are connected, and remains at 70 V. when the rotor runs at speed. The minimum power supplied by the batteries is therefore equal to the power required to spin up the rotor.

This is:

$$P = \frac{1}{2} I W^2 / t$$

where t = time to spin up rotor = 21 sec.

W = angular speed = $2 \times \pi \times 6$ Hz.

$$I = M \left(\frac{R^2}{4} + \frac{L^2}{12} \right)$$

M = rotor mass = 41 kg.

R = rotor radius \approx .08m.

L = rotor length \approx .31 m.

This yields a minimum energy required to keep the rotor spinning at 6 Hz. of 13 Watts. Therefore the batteries must be supplying at least $13/70 = 190$ m amps. As a separate estimate it was found that a constant drain of 300 m amps. through a resistor drops the battery voltage from 125 V to 70 V. Consulting the battery charts we find that a fresh battery with a starting drain of 150 m amps. (100 m amps. when $V = 2/3$ starting voltage) will drop from $2/3$ to $1/2$ of its starting voltage in a few hours. If the batteries began at $2/3$ of their fresh voltage under a drain of 250 m amps. they would be very dead in two hours.

The Newman motor has been run for between one and four hours per day for a total of ten hours. The batteries began at $2/3$ of their fresh voltage, and after the ten hours the voltage had not dropped perceptibly. Mr. Newman intends to continue running the motor a few hours per day to test the limits of his motor. Here again the mechanical energy consumed by the spinning rotor is far in excess of the maximum possible electrical energy which could be supplied by the batteries (according to the charts). An efficiency near 1000% is indicated by the experiment to date.

April 20, 1982. On this date the old batteries have worn down to a point at which they will not even run a 1 1/2 V. small toy motor. Yet when they are connected to the Newman motor, the 90 lb. rotor is spun up to 4.5 Hz. in about 20 seconds!

II. Electrical Energy Output

The Newman motor generates electrical energy by induction. The relevant experiments have been documented elsewhere, and indicate an efficiency of about 400% in the generation of electrical power. Experiments have since been run in which mechanical energy was measured via measurement of the frequency at which the motor runs while delivering a measured torque. Electrical energy was simultaneously generated, and the sum of electrical and mechanical energy was roughly twice the energy obtained when only electrical energy was generated. In this experiment an accurate measure of the input power was not made. Instead, batteries were used and the time required to drain the batteries to a given voltage was measured. It was hoped that the battery charts could be used to estimate the input power. The result was too close to 100% efficiency to rely upon the accuracy of the charts. It should be noted that the measured output energy did not include losses in the belt used to transmit torque. In addition, the whole measurement apparatus was set into motion by the magnetic force during rotation.

III. Static Measurements

Mr. Newman has made measurements of the static torque generated by his 600# magnet at various voltages. These results agree with theoretical predictions based upon measurements of the magnetic moment of the magnet. The predicted torque is:

$$\vec{\tau} = \vec{M} \times \vec{H},$$

and the maximum torque is MH . The static field generated by the coil is:

$$H = \frac{N I}{L}$$

$$N = \# \text{ turns}$$

$$L = \text{coil height}$$

$$I = \text{coil current}$$

(Unit also designed as instructed in Patent Application, Serial No. 179,474, illustrated in Fig. 6, and described in Exhibit A of Declaration by Joseph Westley Newman, September 19, 1981, except Magnet Rotary weighed approximately 400 pounds at that time.)

The magnetic field of the 600# magnet was measured at various distances from the magnet using a Hall effect transducer (factory calibrated). These results were compared with the expression for the dipole field to yield a magnetic moment of $M = 10^7 \text{ } \gamma\text{-ft}^3$ or 100 gauss ft^3 . Therefore the maximum torque is predicted to be:

$$\tau = MH = 2.6 \times 10^{-3} \frac{(NI)}{L} \text{ ft. lbs.},$$

I in amps,

L in meters.

The length of the motor coil is .69 m. and the number of turns is 2,630. Therefore

$$\tau = 9.9 I \text{ ft. lbs. (I in amps).}$$

Mr. Newman's measurements of torque and current are listed below:

Voltage	I	τ	τ/I
6	.6	17.3/4	7.21
12	.98	33/4	8.42
18	.75	29.3/4	9.77
24	1.3	38/4	7.31
30	1.4	47/4	8.39

average 8.2

The value 8.2 for τ/I compares well with the predicted value of 9.9 considering inaccuracies in measuring devices.

It has often been noted by Mr. Newman that for a fixed power input to a coil, the torque increases with the moment of the magnet. If the magnet is made infinitely magnetic the torque becomes infinite, even if the power to the coil is very small.

IV. Dynamic Properties

A.) Inductance

To begin with, the inductance of the 600# magnet motor coil may be predicted and taken from measurement. The predicted value is:

$$L = \mu_0 N^2 \frac{A}{L},$$

A = coil area

L = coil length

N = 2630

With a coil radius of 2.5 feet and 2.25 feet length we predict $L = 23$ henries.

In operation the motor inputs a square wave voltage for a fraction of the roughly 0.5 Hz. cycle. Since the coil resistance is 13Ω , L/R should be much larger than one period, and we predict a current rise of:

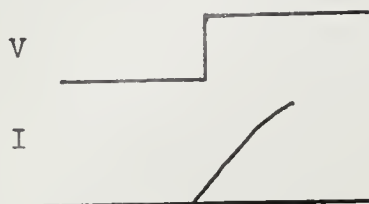

$$I = \frac{V}{R} (1 - e^{-t/L/R}) \approx \frac{V}{L} t$$

From an oscillograph photo with no load on the system, the coil current rises 0.5 amps in 0.1 sec. when 200 volts are switched across the coil. Thus:

$$L = \frac{200 (0.1)}{0.5} = 40 \text{ Henries}$$

The magnet is turning during this measurement so the approximate agreement between theory and measurement is reasonable.

B.) Motor Frequency

Under no load and assuming zero friction, the maximum theoretically possible frequency of the motor is determined by the condition that the induced voltage is equal to (-) the input voltage. The induced voltage is:

$$V_{ind} \approx -w B_{magnet} \pi R_o^2 N ,$$

B_{mag} = magnetic induction of rotating magnet

R_o = coil radius

w = 2π x frequency

With $V_{ind} = -V$ we find:

$$f = \frac{V}{2\pi \pi R_o^2 N B_{mag}}$$

Now $B_{mag} = 2\pi \frac{M}{\pi}$,

M = magnetic moment, π = magnet volume

With $m = .01 \frac{W}{m^2} (ft)^3$, $R_o = .76 m$, $N = 2630$,

$\pi = \pi (1')^2 \times 4' = 12.56 (ft)^3$ we find:

$$f = \frac{V}{4\pi^3} \frac{\sqrt{L}}{M N R_o^2} = .0067 V \text{ (Hz)}$$

$$f = .402 V \text{ (rpm)}$$

At 200 Volts we find the maximum frequency, if the motor had a 100% intrinsic efficiency (no losses), is :

$f = 80.4$ rpm, about double the 600# observed motor frequency under no load.

C.) Energy Input (Theoretical Estimate)

Assuming that:

- 1.) The voltage input and induced emf are 180° out of phase.
- 2.) The voltage input varies sinusoidally.

We have:

$$(V - V_{ind}) e^{i\omega t} = L \frac{dI}{dt} + IR$$

$$I = \frac{V - V_{ind}}{R \sqrt{1 + \left(\frac{\omega L}{R}\right)^2}} \cos(\omega t - Q)$$

$$\text{where } \tan(Q) = \omega L/R$$

The average power consumed by the coil is then:

$$P = \frac{1}{2} \frac{V (V - V_{ind})}{R \sqrt{1 + \left(\frac{\omega L}{R}\right)^2}} \cos(Q)$$

$$P = \frac{1}{2} \frac{V (V - V_{ind})}{R (1 + \left(\frac{\omega L}{R}\right)^2)} \cong \frac{V}{2\omega L} \frac{R}{\omega L} (V - V_{ind})$$

With $\omega = 2\pi \frac{40}{60} \cong 4$, $L = 50$, $\omega L = 200$, $\frac{\omega L}{R} = 20$

$V = 200$ $V_{ind} \cong \frac{1}{2} V = 100$,

$$P = \frac{100}{40} = 2.5 \text{ Watts}$$

This number agrees approximately with Mr. Newman's measurements of input power, in an experiment in which output was measured at about 5 Watts. The numbers used in the above calculation are approximate so the result represents an estimate. The expression for the input power along with the expression for V_{ind} allow a prediction of how input power varies with motor frequency and voltage. The plot is shown in Fig. 2, and the prediction is given below:

$$\text{Predicted Power Input} = \frac{450 \left(\frac{V}{200} \right)^2 \left(1 - \frac{200}{V} \frac{f}{80} \right)}{\left(1 + \left[\frac{f}{3.1} \right]^2 \right)} \quad \text{Watts}$$

V = input voltage (volts)

f = motor frequency (rpm)

This result was obtained by requiring the derived formula to match the experimental result that input power at 200 volts and 35.7 rpm. is 1.8 Watts.

V. Predicted Output Power

The output power is found by averaging the product of torque on the magnet and frequency over one cycle. The torque is given by:

$$\vec{\tau} = \vec{M} \times \vec{H},$$

and $\tau = MH \cos(wt) = \frac{MNI}{L} \cos(wt),$

Where the fact that maximum torque occurs in phase with maximum input voltage has been used. The output power is therefore:

$$P(t) = \frac{MN}{L} \left(\frac{V - V_{ind}}{R} \right) \frac{W}{\sqrt{1 + \left(\frac{wL}{R} \right)^2}} \cos(wt) \cos(wt - Q),$$

and the average power is:

$$P_{out} = \frac{1}{2} \frac{MN}{L} \frac{(V - V_{ind}) w}{R \left(1 + \left(\frac{wL}{R} \right)^2 \right)}$$

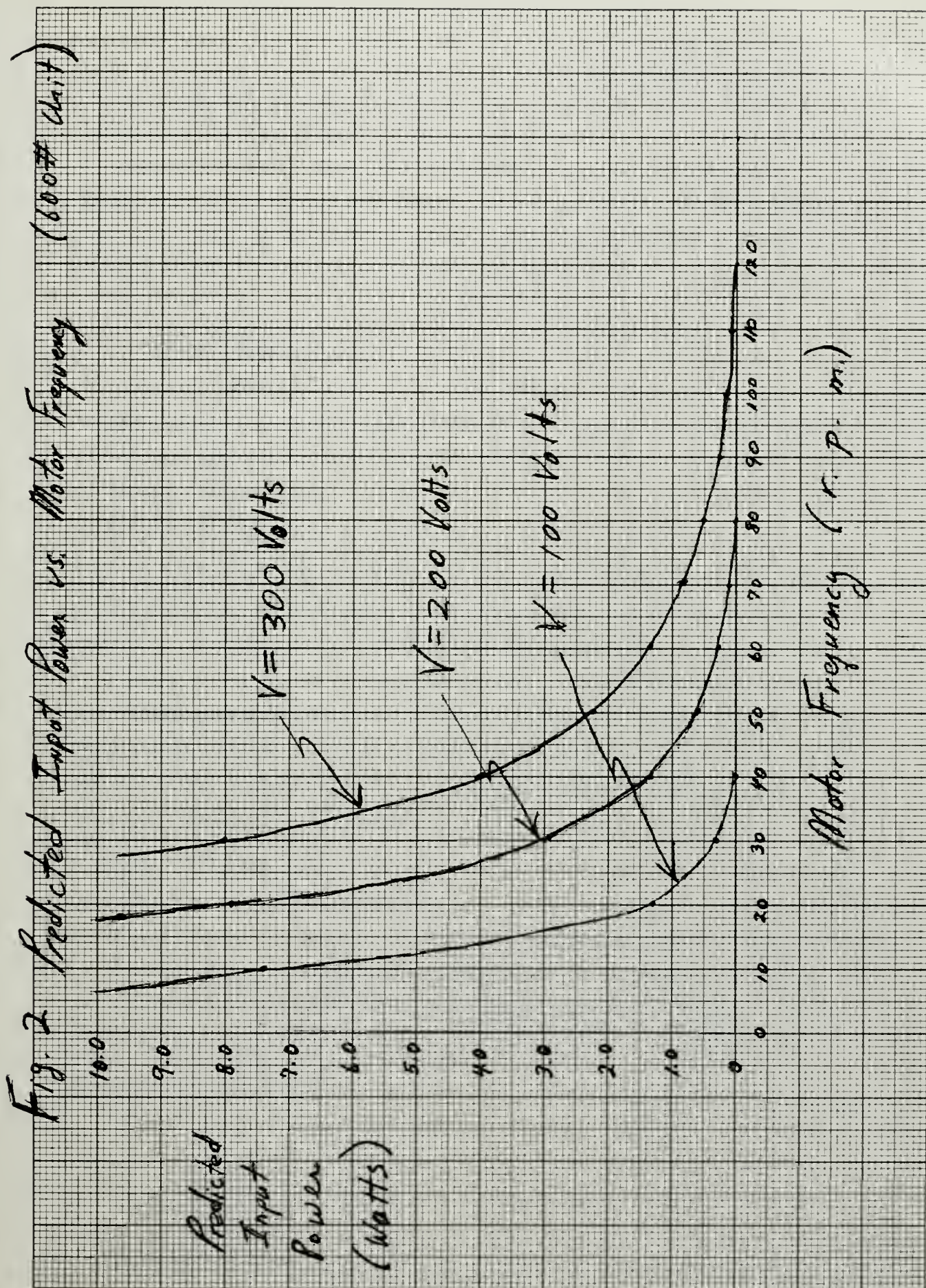

The output power goes to zero at the maximum frequency ($V = V_{ind}$), and also at zero frequency.

VI. Predicted Efficiency

Dividing the expressions for output and input power yields:

$$\text{Predicted efficiency} = \frac{MN}{L} \frac{W}{V} \times 100\%,$$

Where W cannot exceed its maximum value. Using $MN/L = 9.9$ ft. lbs. 1 amp = 13 j./amp yields the following expression for the predicted efficiency of the 600 pound Newman motor:

$$\text{Predicted efficiency} = 1.4 \frac{f}{V} \times 100\%, \quad \begin{array}{l} f \text{ in r.p.m.} \\ V \text{ in volts} \end{array}$$

Operating under no load, the above formula predicts a Newman motor efficiency of 24% (35 rpm at 200 volts). The theoretical maximum motor efficiency is obtained by using the maximum frequency of 80 rpm at 200 V., yielding a 56% upper limit in the case that the motor has zero frictional losses. Working back through the equations it can be seen that the maximum predicted efficiency is given purely in terms of geometrical factors (ratio of magnet volume to coil volume), and cannot exceed 100%.

It is clear that measured efficiencies for the Newman motor are far in excess of predicted efficiencies. The predicted input power is in agreement with measured input.

The measured output power exceeds the predicted output. For example, at 1.8 Watts input and 24% efficiency we expect 0.4 Watts output from the Newman motor. In one experiment the motor generated 5 Watts of output power with 1.8 Watts input drain. The discrepancies are far too large to be explained by experimental errors.

VII. Unusual (Non Conventional) Behavior

As seen above, a number of properties of the Newman motor follow conventional theory. In specific, the input power is as expected. The output power (in excess of input) is the non-conventional result. In my mind the most interesting motor measurement is the oscillograph photos taken around the coil showing very high voltages. This photo also shows the (to me amazing) fact that the coil current is over three times the current at the battery

when the voltage is applied. My opinion is that an excess charge is left in the coil when the input voltage is cut off. At this point a spark appears and a huge induced e.m.f. is created in the coil. This e.m.f. should disappear quickly (showing up as a spike). However, the high voltage remains, having the period of the moving magnet. This indicates that the magnet is "pushing" an excess charge around in the coil, and this appears as excess current when contact is re-established with the battery.

There is also the issue of the "anomalous" current which appears during the spark. It is unclear from the photos whether this current appears in the coil, but it has the proper sign and magnitude to drive the magnet.

VIII. Future Theoretical Research

The upcoming challenge for this writer is to explain the Newman motor output mathematically. The purpose of the above documentation, for me, is to isolate the origin of the excess energy. At that point it is likely that application of a unified theory of charge, matter, and energy, e.g. Mr. Newman's theory, will be required to mathematically describe the results. This mathematical explanation will also have to explain other various embodiments of the Newman Invention, which will obviously result from the Newman Disclosures.

Waiver: I am acting on my own, and am in no way representing Sperry Univac Corporation.

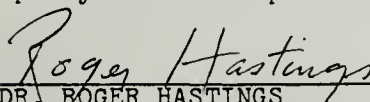
DR. ROGER HASTINGS

DR. ROGER HASTINGS
Principal Physicist
SPERRY UNIVAC CORPORATION
Former Associate Professor of Physics
North Dakota State University
Author of Scientific Literature

Chapter 6

DESCRIPTION OF SMALLER UNIT

WITH AN AFFIDAVIT BY DR. ROGER HASTINGS

The following is a smaller unit (see photograph 15-C2 below) composed of 30-gauge, insulated, copper wire weighing approximately 145 lbs. (atoms) and having a rotating magnet of 14 lbs. (atoms). This portable unit, with very little current input, clearly demonstrates an energy output which is greater than the external energy input. With 300 volts input of pressure, only 1½ milliamps of current (volume of gyroscopic particles) went into the copper coil (of atoms), which is less than ½ watt input for an energy output in excess of 10 watts.

Photograph 15-C2:

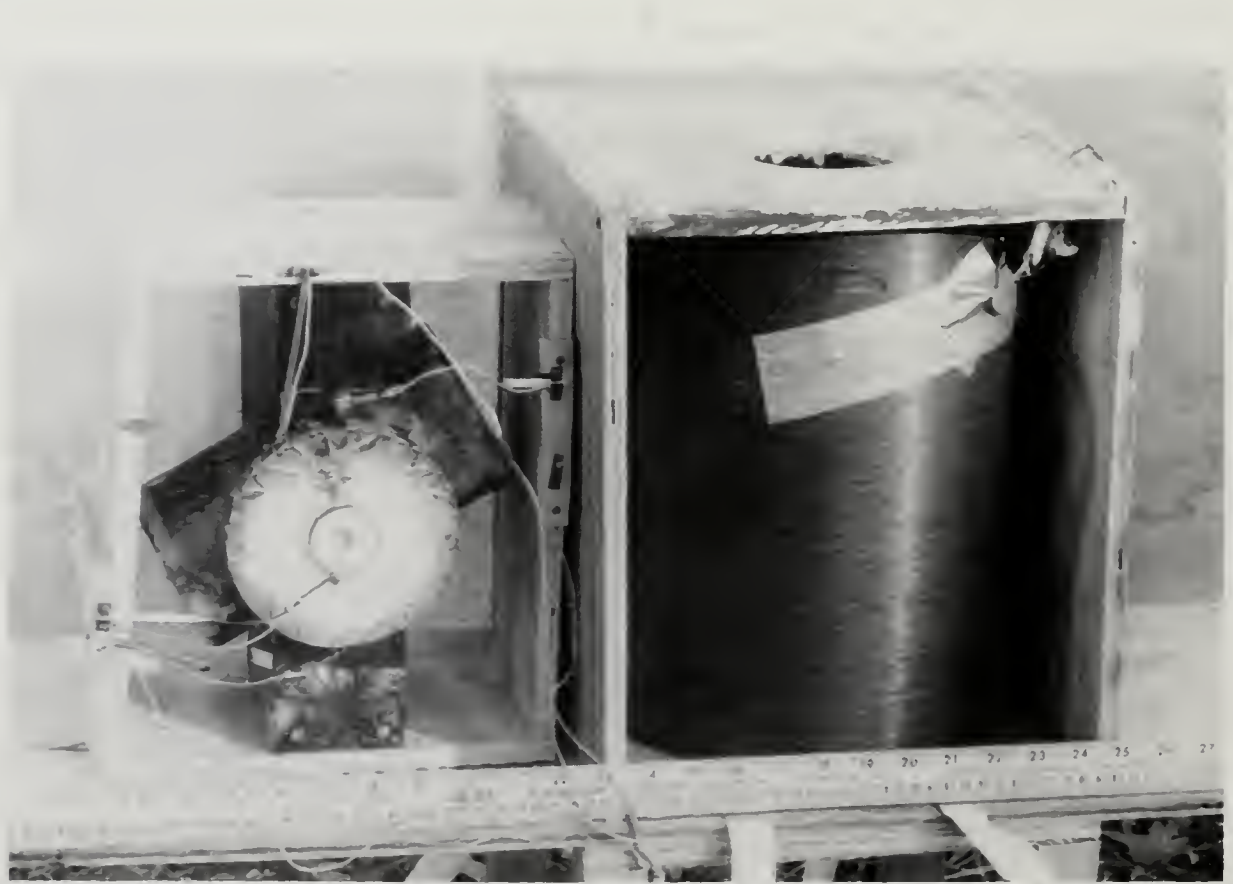

PHOTO BY MATT ANDERSON

See below copy of a test conducted by Dr. Roger Hastings utilizing the 15-C2 unit.

June 17, 1984

TO WHOM IT MAY CONCERN:

On June 16 and 17, 1984 I ran a series of tests on Joseph Newman's 145 lb. motor with 14 lb. rotary. These tests show that power is generated by the motor which greatly exceeds the battery input power. The results are summarized briefly below:

1. Demonstration of Large Current Spikes Produced by the Motor

A. Oscilloscope Readings

The oscilloscope showed large (*1 Amp) staircase current spikes of significant time duration, which were initiated when the commutator switched, and flowed both in the coil and battery portions of the circuit. A picture of this spike taken on the coil side of the commutator is attached. A block diagram of the circuit is shown below.

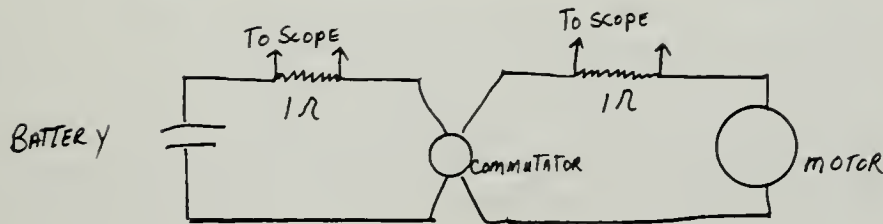

B. Circuit Breaker Tests

An ammeter which has a built in circuit breaker was placed in the circuit. When the meter was placed on the 100 ma scale, the breaker opened, both on the battery and coil side of the commutator.

The breaker did not open when the meter was placed on the one amp scale, however, it was verified that a current input of more than 1.5 times the full scale deflection did not open the breaker.

C. Temperature Rise

A five hundred ohm resistor was placed in series with the battery. The resistor was water-proofed and placed in a small thermos container with a precision thermometer. A temperature rise of approximately one degree Centigrade was observed in a period of fifteen minutes. To raise the temperature of the 21 grams of water by 1 degree in fifteen minutes requires at least an average power of:

$$P = \frac{1 \text{ cal}}{\text{gm}^\circ\text{C}} \times 21 \text{ gm} \times 1^\circ\text{C} \times 4.19 \text{ J/cal} \\ \frac{\hspace{10em}}{15 \text{ min} \times 60 \text{ sec/min}} = 0.1 \text{ Watts}$$

Since the power supplied by the current flowing in the resistor is I^2R , where I is the average current and $R = 500 \Omega$, it follows that a current of at least 14 ma on the average must flow in the circuit. This result was verified experimentally by supplying 14 ma to the 500Ω resistor via a battery and series resistors. If the current contained in the spikes (attached photo) is averaged over the cycle time, the result is consistent with an average current of 14 ma.

2. Demonstration that Large Current Spikes are not Produced by the Battery.

A. Current Readings

When a Simpson amp meter is placed in series with the batteries, a d.c. input current of 1.2 ma is registered. The battery input current is therefore 1.2 ma.

B. Expected Input Current

When the rotor is stopped, the input current from the batteries is measured to be 6 ma (this is in agreement with 304 volts and $50 \text{ K}\Omega$ coil resistance). The coil inductance, as calculated from the number of wire turns and the geometry, is 16,000 Henries. At the operating speed of 136 r.p.m., the inductive reactance of the coil is $230 \text{ K}\Omega$, which is much larger than the coil resistance. The expected battery input current is $304 \text{ V}/230 \text{ K}\Omega = 1.3 \text{ ma}$, in good agreement with the measured input of 1.2 ma.

C. Constant Battery Voltage

During four hours of continuous running of the motor, the voltage remained constant at 304 volts. If the 15 ma average current contained in the spikes came from the batteries, they would drain down significantly in the four hour period. By

draining 14 ma from a fresh 9 volt transistor battery identical to those on the motor it was found that the 14 ma drain causes the voltage to drop by 2% per hour. Thus if the 14 ma were originating at the battery, the battery voltage would drop by 24 volts in four hours. No drop was observed.

D. Larger Current Spikes on Coil Side

The current spikes, as recorded on the scope, were larger on the coil side of the commutator than on the battery side. This indicates that the spikes originate at the coil, with some loss occurring at the commutator.

E. Negative Current

A significant portion of the spike in the battery circuit is negative (opposing the battery voltage). The battery cannot generate such a negative current.

F. Dependence Upon Rotary Position

The intensity of the spikes varies greatly with the placement of the rotary. For example, when the rotor is on the side (outside) of the coil the spikes are large. They virtually disappear when the rotary is placed on top of the coil.

3. Power and Useful Output

A. Output verses Input Power

Since an average of 14 ma flows through the 50 K Ω coil, the heat dissipated in the coil is ten watts. The battery input is 1.2 ma times 304 volts, or 0.36 watts. The heat generated in the coil is 27 times the input power. Note that if the ten watts were delivered by the batteries, they would drain down very quickly. These batteries have been used in frequent demonstrations for long durations by Mr. Newman over the past several months. As mentioned above, four hours of motor operation during these tests did not measurably lower the battery voltage.

B. Useful Output

Mr. Newman placed a 75 Watt, eight foot, flourescent tube across the motor coil, and the bulb lit to perhaps 10% of full brightness. Interestingly, when the bulb was inserted, the rotary gained speed, and the motor drew less current from the batteries! The lit 75 watt tube demonstrates useful output of several watts, with a fractional watt input power.

I swear the above statements are true and accurate to the best of my knowledge.

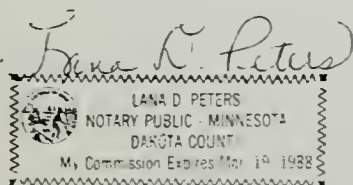

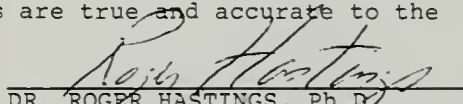
DR. ROGER HASTINGS, Ph.D.

Chapter 7

ADDITIONAL AFFIDAVITS

Additional signed Affidavits as well as television news endorsements have been provided by more than 30 competent individuals including myself. These Affidavits include physicists, a nuclear engineer, electrical engineers, aeronautical engineers, chemists, mechanical engineers, electronic/technical individuals, and others. These individuals are listed below, and these individuals should be complimented for their courage, since they were well aware of the significance of the impact of what they were saying.

ENDORSERS OF JOE NEWMAN'S DEVICE

Jerry A. Miller
16675 Spruce Circle
Fountain Valley, California 92708
Profession: Electrical Engineer

Joseph Richard Trinko, Ph.D.
4635 Dryades Street
New Orleans, Louisiana 70115
Profession: Nuclear Engineer

Bobby Matherne
5901 Marcie Street
Metairie, Louisiana 70003
Profession: Physicist

John P. Gillis
4509 Tartan Drive
Metairie, Louisiana 70003
Profession: Dentist (physics background)

Eric J. Szuter
2301 Edenborn #807
Metairie, Louisiana 70001
Profession: Mechanical Engineer

Evan R. Soule', Jr.
1135 Jackson Avenue, #305
New Orleans, Louisiana 70130
Profession: Educational Contractor (physics background)

Henry T. Dart
3636 Jena Street
New Orleans, Louisiana
Profession: Attorney (physics background)

Marc Kahgan
5014 South Prieur Street
New Orleans, Louisiana 70125
Profession: Physician (physics background)
Director of Electronic Company

Douglas R. Mapes
2544 Robert E. Lee Boulevard
Apartment 210
New Orleans, Louisiana 70124
Profession: Student (electronics background)

Leslie D. Jensen
14144 Woodland Ridge Avenue
Baton Rouge, Louisiana 70816
Profession: Chemical Engineer

Gary N. Krasnow
933-B Louisiana Avenue
New Orleans, Louisiana 70115
Profession: Architect (physics background)

Arnold R. Smythe, Jr.
234 Glendale Drive
Metairie, Louisiana 70001
Profession: Consulting Structural Engineer

James H. Wilson
1701 Beltline Highway
Mobile, Alabama 36609
Profession: Civil Engineer

Robert E. Melton
401 Firestone Drive, East
Mobile, Alabama 36601
Profession: Electrical Engineer

Roger Hastings, Ph.D.
1204 Circle Hyde Drive
Burnsville, Minnesota 55337
Profession: Physicist

Thad M. Lee
3450 Armour Drive
Mobile, Alabama 36609
Profession: Electronics Technician

Patricia Wright
3450 Armour Drive
Mobile, Alabama 36609
Profession: Electronics Technician

Wayne Powell
3450 Armour Drive
Mobile, Alabama 36609
Profession: Electronics Technician

C. Emmett Pugh
1250 Poydras Street, Suite 2200
New Orleans, Louisiana 70112
Profession: Patent Attorney/Engineer

Gregory Upchurch
611 Olene Street
St. Louis, Missouri 63101
Profession: Patent Attorney/Electrical Engineer

Milton K. Everette
Mississippi State Department of Energy
and Transportation
510 George Street
Jackson, Mississippi 39202
Profession: Mechanical Engineer

Richard Vialton
Education: M.S., M.I.T., Electrical Engineering
Profession: Engineer with major manufacturer
of oscilloscopes

Lawrence C. Gibbs
5736 Citrus Blvd.
Harahan, Louisiana 70123
Profession: Building Engineer

Mansur Nathoo, Ph.D.
4 Little Stream Close
Northwood, Middlesex, England
Profession: Solid State Physicist

Thomas J. Herold
12117 Comanche Trail
Huntsville, Alabama 36803
Profession: Ph.D. Business Administration

Eike J.W. Mueller
NASA/MSFC
Code JA11
Marshall Space Flight Center, Alabama 35812
Profession: Aero-Space Engineer

Joseph E. Bolger
1404 Alegria
Austin, Texas 78757
Profession: Nuclear Engineer

Ralph Hartwell
WWL T.V.
New Orleans, Louisiana
Profession: Electrical Engineer

Ted Saari, Jr.
WWL T.V.
New Orleans, Louisiana
Profession: Electrical Engineer

Mort Zimmerman
High Tech Company
Dallas, Texas
Profession: Electrical Engineer

In tribute to the above-listed, caring and courageous, scientifically-minded individuals who spoke out on behalf of this technology and on behalf of humanity — and who deserve the respect of all who read this book — I insert several of the most recent proofs that they and the technology I teach is correct.

[See the following pages for newspaper clippings concerning my automobile demonstration.]

The facts of my automobile presentation echo and amplify the statement made by the Special Master who was chosen as an expert by a Federal District Court and who was nominated by the U.S. Patent Office. Special Master William E. Schuyler, Jr. stated that the facts were "overwhelming" that my invention worked and that there was "no contradictory factual evidence." (See Section 7A on page 274.)

Schuyler's statements and the facts of this case provide the above-listed individuals the credit they are due. The following pages (46, 47, and 48) depict several of the genuine tests conducted by these caring individuals who are a credit to the Scientific Method and to the principles relative to the advancement of the Human Race.

Lucedale inventor hits the road



J.D. SCHWALM/The Clarion-Ledger

Joe Newman of Lucedale talks to reporters from behind the wheel of his energy car during a demonstration Wednesday. Newman drove the car a half mile down the Old Mobile Highway in the Rocky Creek community at about 4 mph.

Success! Newman's 'gyro-power' car works

By VALERI OLIVER
Clarion-Ledger Gulf Coast Bureau

LUCEDALE — Inventor Joe Newman's red, home-built car sputtered, then hissed and whirred its way down a rural backroad Wednesday, a feat Newman says will ultimately change the world.

"What y'all are seeing this morning is history," Newman told a gaggle of reporters and photographers gathered on Old Mobile Highway east of Lucedale for the demonstration.

Newman—

ability to power the 1,800-pound car Newman claims to have used more than 170 pounds of the batteries, along with 200 pounds of copper wire, to harness the energy of tiny gyroscopic particles contained within the electromagnetic field, which he said is the building block of the universe.

"The energy comes from the atoms of the conductor, the atoms of a magnet," he said.

As Newman prepared to start the car with the aid of a mechanic, he warned reporters not to touch the car's surface. "It will sure light you up," he said.

The car then sputtered to life and a sign above the back bumper reading "Gyro Power" lighted up. With Newman at the wheel, the auto heaved forward. The inventor drove the slow-moving vehicle down the highway about a half mile and back, all the time answering questions from reporters striding alongside. Then he turned the car off.

Newman said his electronic car, which ran at 4 mph, is proof of a breakthrough in physics. He brought his car to Jackson in December for a demonstration, but that test was aborted, he said, because the car was damaged on its way from Lucedale to the Mississippi Coliseum.

Newman said Wednesday he wanted to show off his energy machine-powered car closer to home to prove that his controversial theories are so basic they can be done even in the backwoods of George

County.

"If the scientific community is right, then there's no way that this battery will move this car. There is no way that a zillion of them would even turn this thing over," Newman said before he started the vehicle.

The inventor held up a tiny 1.5-volt battery that he claims is the force behind the energy machine's

See Newman, back page this section

Newman said the electronic car can travel about 4 mph and can go up slight inclines. The inventor said he first powered the car on Jan. 30 before a small group of George Countians, a demonstration that reportedly lasted 30 minutes.

If the technology were stepped up, he said, cars could be powered to a speed more practical, and even space travel could use the process.

"I'm doing all this in the backwoods of Lucedale, Mississippi. What do you think would happen if big industry got behind it?" he asked.

But industry hasn't supported the idea, and neither have the U.S. Bureau of Standards and the Patent and Trademark Office. An application by Newman for a patent has been rejected. Patent officials say his theories don't prove the machine produces more energy than it consumes.

"I support Joe Newman," said George County Chancery Clerk Jerry Harvey, among those watching the exhibition Wednesday. "The only thing I understand about electricity is if you stick your finger in a socket, you'll get it. But Joe Newman is ethical. If he says it works, it works."

About \$100,000 was spent developing the car, Newman said, and another \$800,000 has been spent fighting the patent office.

But the money's not important, he said.

Newman criticized U.S. District Judge Thomas P. Jackson, the presiding judge in the inventor's federal court case in Washington, D.C., and President Reagan for "keeping this invention from the public."

A decision on his appeal is pending. A small crew of Lucedale supporters gathered along the country road to watch the display.

Newman operates energy car

By JUNE HEYDT
 Press Register Correspondent
 LUCEDALE, Miss. — Many scientists, engineers and even the U.S. Patent Office said it couldn't be done. But on Wednesday afternoon in Lucedale, Miss., Joseph Newman ran his unique automobile.

The 1,800-pound car, which looks like a Corvette, was powered by a small, one and one-half volt transistor battery, according to Newman.

"Physics books of today say this cannot be done," Newman said about his energy machine. "However, I have taken numerous one and one-half volt transistor batteries connected in a series-manner to provide high voltage, producing a low speed, and moved an 1,800 pound automobile."

The bright red automobile was driven at approximately 10 mph over the Old Mobile Highway in the Rocky Creek community in Lucedale.

Newman said the current from the small transistor battery should not have moved his car, much less run it,

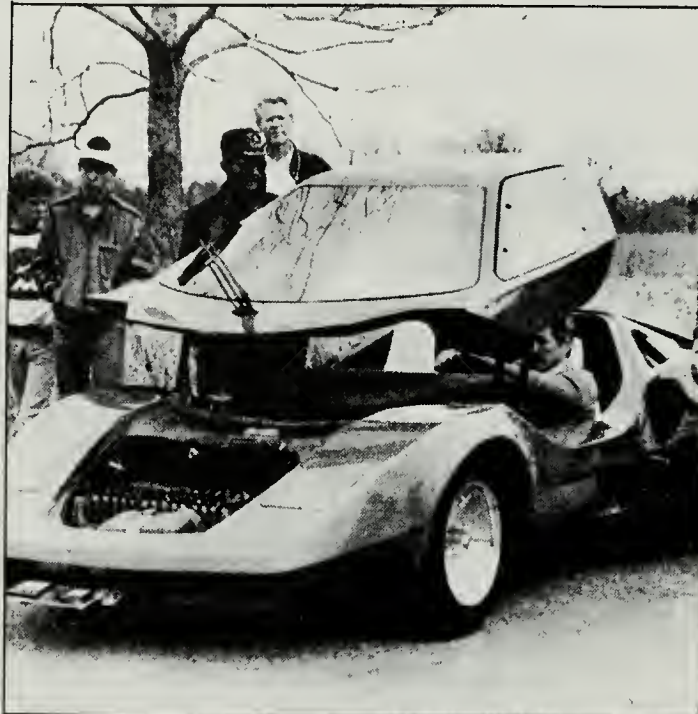

Press Register photo by Correspondent June Heydt

Joseph Newman of Lucedale, Miss., tests his energy machine-powered sports car on Old Mobile Highway in Lucedale while supporters watch.

■ Please see Page 8, Col. 5

Newman

■ Continued From Page 1

if the laws of science now taught concerning electro-magnetism were true.

"For it having done so proves that the magnetic field must have come from the basic make-up of the more than 200 pounds of atoms in the copper coil of the motor, and the 200 pounds of atoms in the permanent magnet of the motor," said Newman, adding that he has been trying to explain his theory for a decade.

Newman said the energy released from his machine more thoroughly employs Einstein's equation of E equals MC-squared than other energy-producing machines in use today. He said his machine produced more energy than it receives, and it does so without polluting the environment.

Newman is still fighting an eight-year battle with the U.S. Patent Office to get a patent for his invention.

After losing so many battles with the patent office, Newman decided he would take his invention to the best source: the public.

"People are not stupid," he

said. "They have common sense. They won't let something like this be kept down for long. This is an invention that will change the environment, the economy and the standard of living. It will do away with poverty and really make it a world of growth."

When Newman was asked why he thought the government was fighting him, he said, "This is just history repeating itself. Men in power have always resisted change. There are billions and billions of dollars invested in the oil companies. Of course, they are going to fight it. This new technology will change the whole economy of the country." He said men in power seem afraid this invention will put people out of jobs. "But, on the contrary," he said, "for every job that's lost, a thousand will be born."

Newman said that in 20 years his newly discovered technology will make space travel as common as taking an airplane trip. He said the entire universe is electro-magnetic and that this energy has always been here.

Hundreds of Lucedale residents have been supporting Newman during his attempt to patent the device.

It Does, Does Run, Run, Run—

Yes, it does run. Joe Newman's invention of a battery powered automobile, does defy the laws of physics. This invention is not developed to the extent of being able to drive like a conventional gas operated automobile of today. But, neither was the very first automobile. Neither was the Wright Brothers' first airplane ready for mass production in its early days.

Somchow, someway, Newman is proving something new has gigantic possibilities of developing into a new source of energy. For over seven years the U.S. Patent Office people have offered virtually no encouragement; they say it is impossible. The United States government has turned a deaf ear.

Our own U.S. Congressional delegation has shied away from this issue. Of course, several of our U.S. Congressmen have put potential bills for a pioneer patent in motion. But, these potential bills are dying for lack of action. A bill for a pioneer patent can become stagnant if the legislation is never acted on. A bill is a potential bill if it is never aired out in Congress!

Just think how much farther along this invention could be today if our government, our own Mississippi Congressional delegation, and our U.S. President had been forceful and actively pushing for a pioneer patent for this inventor.

Look how quick our U.S. Congress is getting their own congressional pay raise. It is a shame our U.S. Congress is not as interested in obtaining a patent for Newman as they are in getting their own

pay raise.

Last Wednesday, Feb. 4, Newman drove his energy powered automobile on the 'Old Mobile Highway' between Rocky Creek Road and Brushy Creek Road. His historic ride ranged from east of Rocky Creek Road to the intersection of Old Mobile Highway and Brushy Creek Road. He turned around at the intersection of Old Mobile Highway and Brushy Creek Road and returned to his start of beginning. His travel was at approximately five miles per hour and lasted about one hour, including his explaining of his invention. Three television stations, newspaper reporters, photographers and several supporters were on hand to witness history being made.

What he (Newman) has done is prove the experts wrong. The laws of physics says this cannot be done. Newman is improving the efficiency of the use of energy. Newman has taken approximately 200 pounds of cooper coil and a 200 pound magnet to efficiently use the power built up from these materials. He also uses a series of (numerous) one and one-half volt transistor batteries to aid in powering the vehicle.

Remember how you can hold a nail up to a magnet and make some kind of a force field. Apparently Newman is harnessing this force field.

As evidenced by the facts concerning electromagnetism, the current from this small one and one-half volt transistor battery should not have moved the car, much less run it. Newman explains "for

it having done so proves that the magnetic field must have come from the more than 200 pounds of atoms in the copper coil of the motor and the 200 pounds of atoms in the permanent magnet of the motor."

We accept this theory. We don't understand it, but, we do know that there is an untapped force field within a magnet. We also know Newman's invention is harnessing this force field. We agree it must be the atoms of this force field propelling the 1800 pound automobile.

We are sure there was a time when the theory of hydroelectric energy was not understood. But, just because it wasn't understood at that time was no reason it was never to be developed. We all know it was developed. The power source was always there. First it had to be experimented with, then it had to be developed, then it was there.

Every member of the Mississippi Congressional delegation should take the Newman pioneer patent bill off the back burner. It is time for the U.S. Congress to stop stalling and work to provide the people of the United States with the possibilities of developing a new source of energy power.

At this stage of the game we don't know if this invention will prove feasible in the (world) marketplace. But, we also don't know that it will fail, either. We do know this invention is proving the U.S. Patent Office wrong. They still say it is impossible.

Newman says it will prove to be our new source of energy. No one has proved him wrong, either. All they have done is deny him a patent. In America every man should have the opportunity to prove himself right or wrong.

It will be a crime if it takes twenty years to develop this invention (without a patent). While it may have taken less than five years (with a patent).

Without a patent it will take twenty years! With a patent it will take much, much less time. You, the consumer, will be the ones to pay the price if this invention development is delayed years and years. All at a time when America desperately needs a new energy source.

Since the OPEC Oil embargo of the early 1970's the U.S. economy has been sick. The entire free world, especially the developed countries have been staggering. A new energy source is our only answer.

Why is the Newman pioneer patent bill on a back burner?

GEORGE CO. TIMES

EDITORIAL

OPINION

Opinion

Newman merits more support

Is Lucedale, Miss., the Kitty Hawk of this generation?
Could be.

It was in that nearby municipality that former Mobilian Joseph Newman on Wednesday afternoon drove a 1,800-pound car which he said was powered by a unique battery system — something which the experts said could not be done.

They had said much the same thing about the Wright brothers' flying machine before they got it into the air in 1903. Where would we be today without the airplane?

Although Newman's sleek sports car moved at only a few miles per hour, we should remember that the flying machine devised by Orville and Wilbur Wright barely got airborne on that historic flight.

The point is that American innovation is still alive and well today, just as it was nearly a century ago.

Instead of denying Newman a patent — indeed, fighting him every step of the way — federal bureaucrats and the entire nation should give him full backing to determine if he has defied conventional theory and produced a new form of energy. We are not saying that Newman is right or wrong — simply that he should be given a chance to prove his point.

"Physics books of today say this cannot be done," Newman said of his energy machine.

Newman said it proved that "the magnetic field must have come from the basic make-up of the more than 200 pounds of atoms in the copper coil of the motor and the 200 pounds of atoms in the permanent magnet of the motor."

Whatever that means, we are convinced that Newman deserves a better shake than he has received to date from the U.S. Patent Office and others.

Alabama and Mississippi congressional delegations should add their influence to what amounts to a growing public outcry for Newman to get his patent and an opportunity to usher in a new era of energy usage.



EXHIBIT 1

INPUT ELECTRICAL ARRANGEMENT

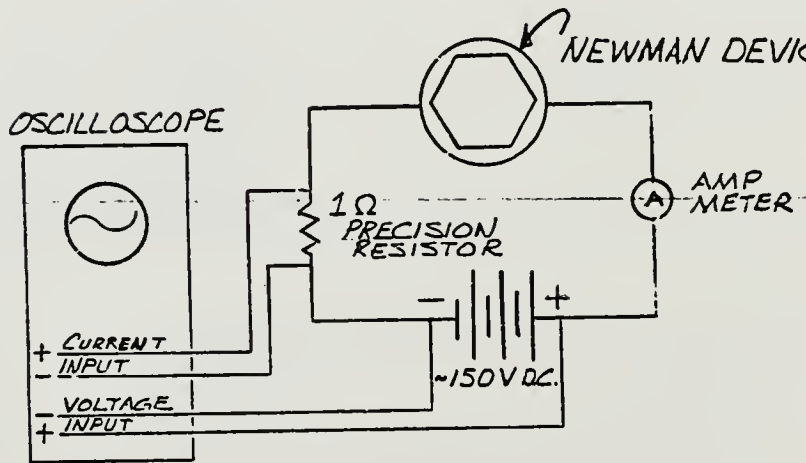
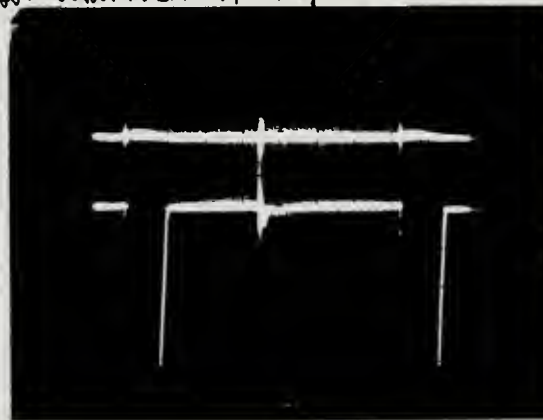

EXHIBIT 2

Volt: 50 Volts per Cent 14th May



Current = .1 Amp per Cent Sweep time = 50 MS / Cent

EXHIBIT 3

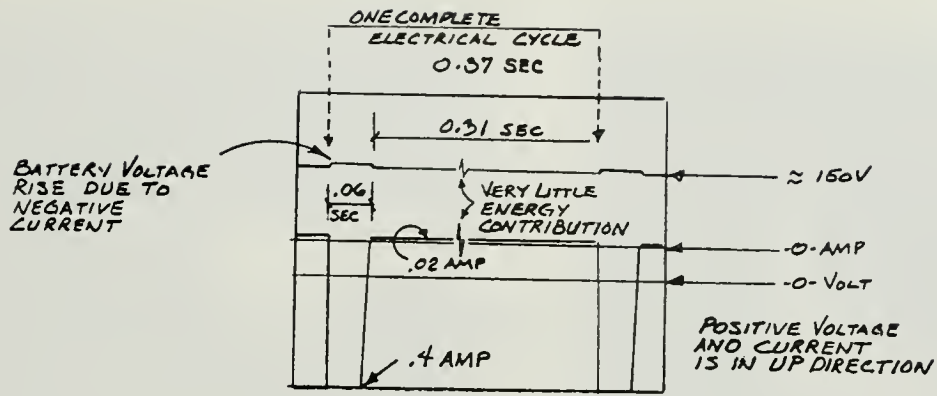
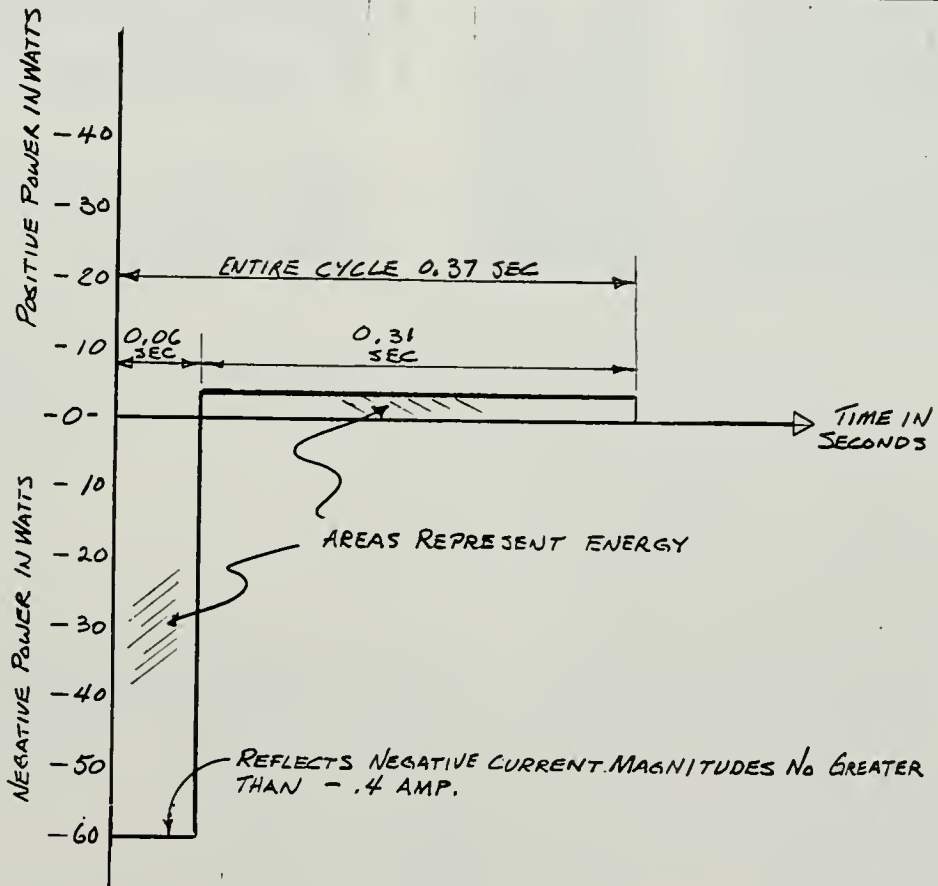

EXHIBIT 4

RECONSTRUCTION OF EXHIBIT 3



POWER IN WATTS AS A FUNCTION OF TIME
ONE CYCLE

EXHIBIT 5



EXHIBIT 6

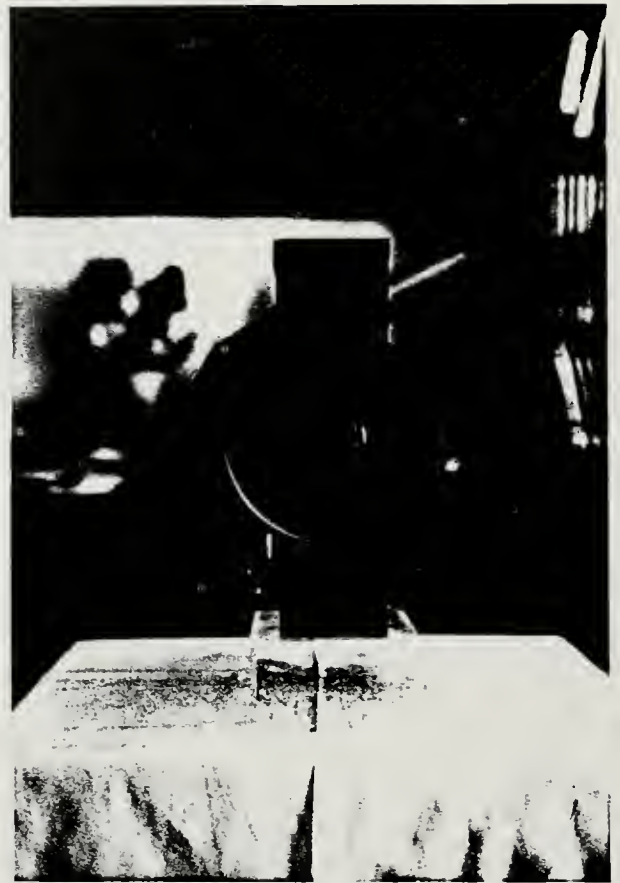

EXHIBIT 7

OUTPUT PHYSICAL ARRANGEMENT

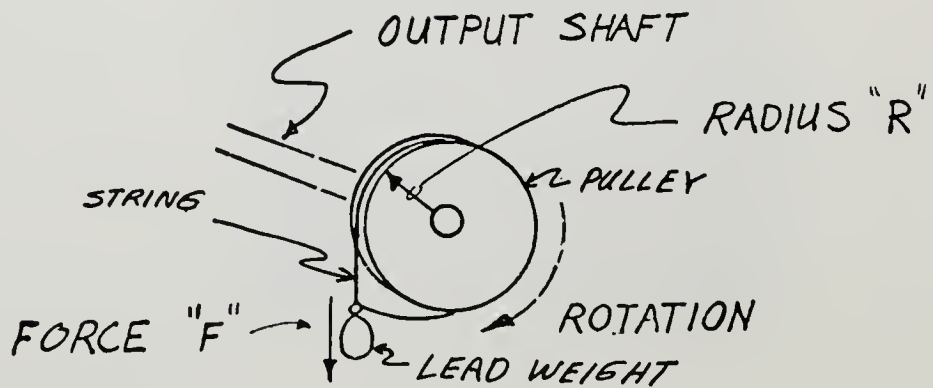

EXHIBIT 8

Chapter 8

ANALOGIES USEFUL

IN UNDERSTANDING

THE TECHNICAL SYSTEM

"A new scientific truth does not triumph by convincing its opponents and making them see the light, but rather because its opponents eventually die, and a new generation grows up that is familiar with it."

— Max Planck

I will now discuss in greater detail "how" and "why" my conducting-coil-unit operates.

16. Let us study another analogy (see 16-A and 16-B below):

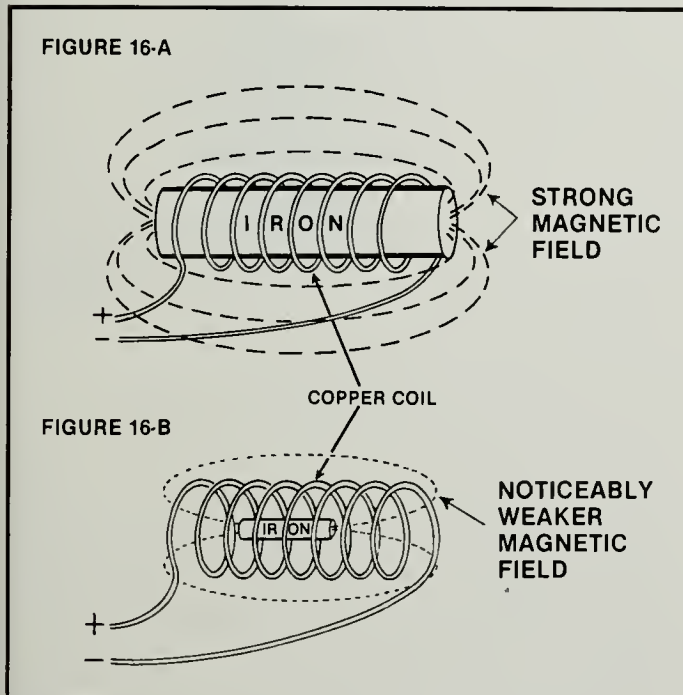

If 1 amp of current goes into Figure 16-A, a noticeably larger magnetic field occurs than in Figure 16-B (for the same current input).

QUESTION: Why the large difference in the strength of the magnetic field?

ANSWER: Simple. We have already demonstrated that the iron becomes magnetic due to atom alignment. Therefore, via the small electrical input acting as a catalyst, *we have simply caused more atoms to align in the larger mass of iron in Figure 16-A above than in the smaller mass of iron in Figure 16-B.*

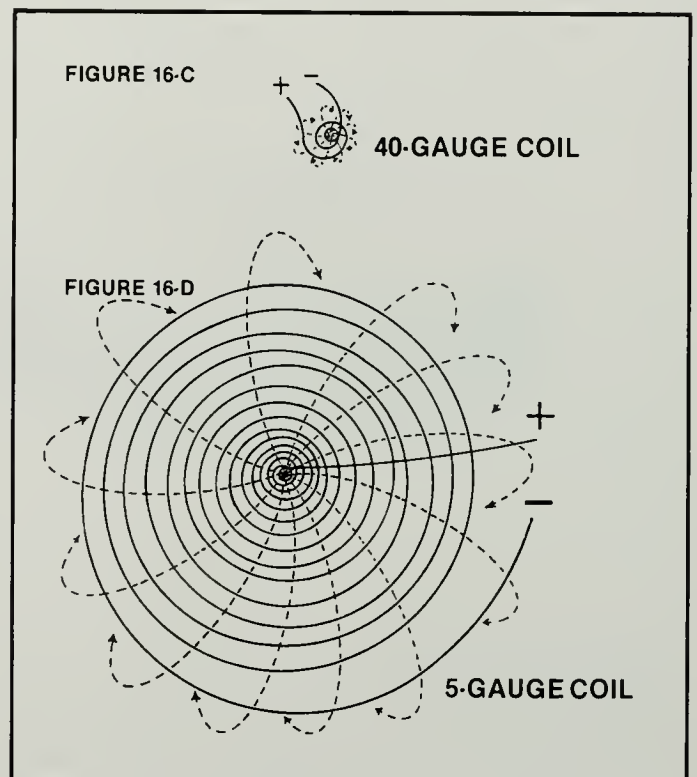

If 1 amp of current goes into Figure 16-C, a noticeably smaller and weaker magnetic field occurs than in Figure 16-D.

QUESTION: Why the difference?

ANSWER: Simple. As we have already proven, we have more copper atoms to align in coil 16-D than in coil 16-C.

16

E. All of the facts presented in Sections 1-16 clearly prove that the current (consisting of gyroscopic particles in motion) put into a conductor simply acts as a catalyst in aligning the atoms of the conductor itself. This same catalytic effect is observed if a conductor is

wrapped around iron and the current runs through the conductor. In other words, the current simply acts as a "pure catalyst!" The current input triggers the atom alignment which results in energy (gyroscopic particles) being released from the atoms aligned. However, the electrical current input does *not* participate in the magnetic field released.

¹⁶
F. There is another important mechanical effect of the gyroscopic particles comprising a magnetic field, electric field, and all matter, which I refer to as a "Hydraulic Effect." (See Figure 16-F1.)

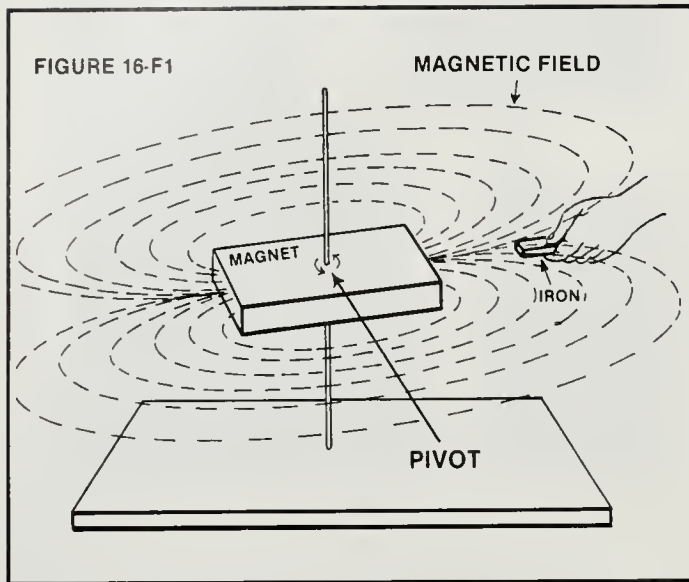

If one places a piece of iron in a magnetic field and the source (magnet) is fixed to a pivot (see Figure 16-F1 above), then, if the piece of iron is moved, the magnet will also attempt to move. It is mechanically obvious that there is a magnetic "coupling effect" generated by flowing "streams or shells" of gyroscopic particles comprising the magnetic field and originating from the atoms of the magnet. I originally asked myself: "How else could there be an action-reaction effect?" Any motion whatsoever on the part of the piece of iron will cause an attempted motion of the magnet itself. This action is the same type of effect as found in a hydraulic system. (See Figure 16-F2.)

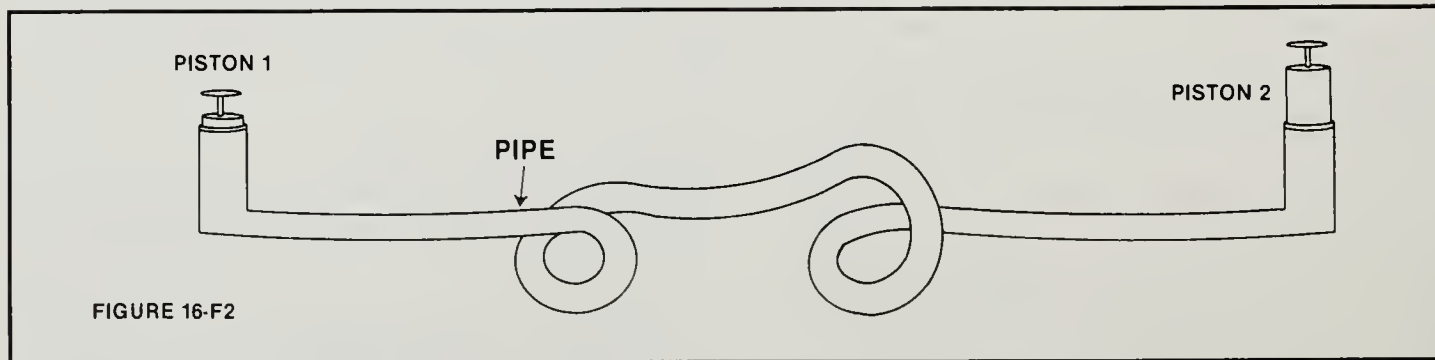

If the pipe is filled with fluid and the piston is moved, then piston 2 will also move. If the pipe is filled with a gas and piston 1 is moved, then piston 2

will also attempt to move. However, enough pressure can be imposed on piston 2, causing the gas molecules to compress into a smaller area within the pipe. *The same effect can be found in magnetics.*

¹⁶
G. The same type of hydraulic effect can be observed in the electric current (gyroscopic particles) coming from a battery or generator and flowing into a conductor to align the atoms within the conductor. The atoms of the conductor are aligned due to the pres-

"The current input triggers the atom alignment which results in energy (gyroscopic particles) released from the atoms aligned. However, the electrical current input does not participate in the magnetic field released."

sure of the voltage from the battery or generator. The current (gyroscopic particles) that is derived from the atoms of the material within the battery or the atoms within the conductor and magnet of the generator is the energy which comprises the atoms of the material from which the current (gyroscopic particles) originates. The gyroscopic particles actually create a hydraulic effect back to the atoms from which the gyroscopic particles come. This action is mechanically similar to any hydraulic pumping system.

¹⁶
H. There is a most important distinction, however, between the power source of conventional hydraulic systems and that which I have discovered and developed. The current (gyroscopic particles) which comes from a battery or generator is the energy which comprises the atoms of the materials from which current (gyroscopic particles) comes. This action is literally the mechanical essence of Einstein's Equation $E = MC^2$.

Therefore, a battery connected to the proper output system will be destroyed in accordance with $E = MC^2$! I am not referring to the present, inefficient chemical reaction within a battery, since present teachings state that all energy-producing devices (which use current) operate via the current input only. This is not true!

Such present teachings have resulted in designs for inefficient battery devices which are deliberately constructed to use relatively high current. I teach the

opposite. One should build devices to use *as little current as possible and practical* in order to restrict that current from completing the circuit and returning to the battery or generator.

EXAMPLE: Let's examine a typical battery — an electrochemical cell. These devices operate according to Faraday's Laws. Faraday's First Law states that the quantity of electricity that passes through a solution is proportional to the quantity of substance decomposed. You will note that this action is solely dependent upon the current (gyroscopic particles) completing the circuit. If the current (gyroscopic particles) does *not* complete the circuit, *there will be no quantity of substance decomposed.* (See Figures 16-H1 and 16-H2.)

duction effect would have far greater power than that which originally came from battery 16-H1 on a chemical basis only. If you, the reader, have now mastered what I have taught, you will quickly recognize that the action-reaction effect within coil 16-H2 and the hydraulic effect of battery 16-H1 all operate in accordance with $E = MC^2$.

“One should build devices to use as little current as possible and practical ...”

In effect, the current (consisting of flowing, gyroscopic particles) coming from the atoms of coil 16-H2 and battery 16-H1 are *the mechanical essence of $E = MC^2$* and, consequently, the mass of the entire system will be re-

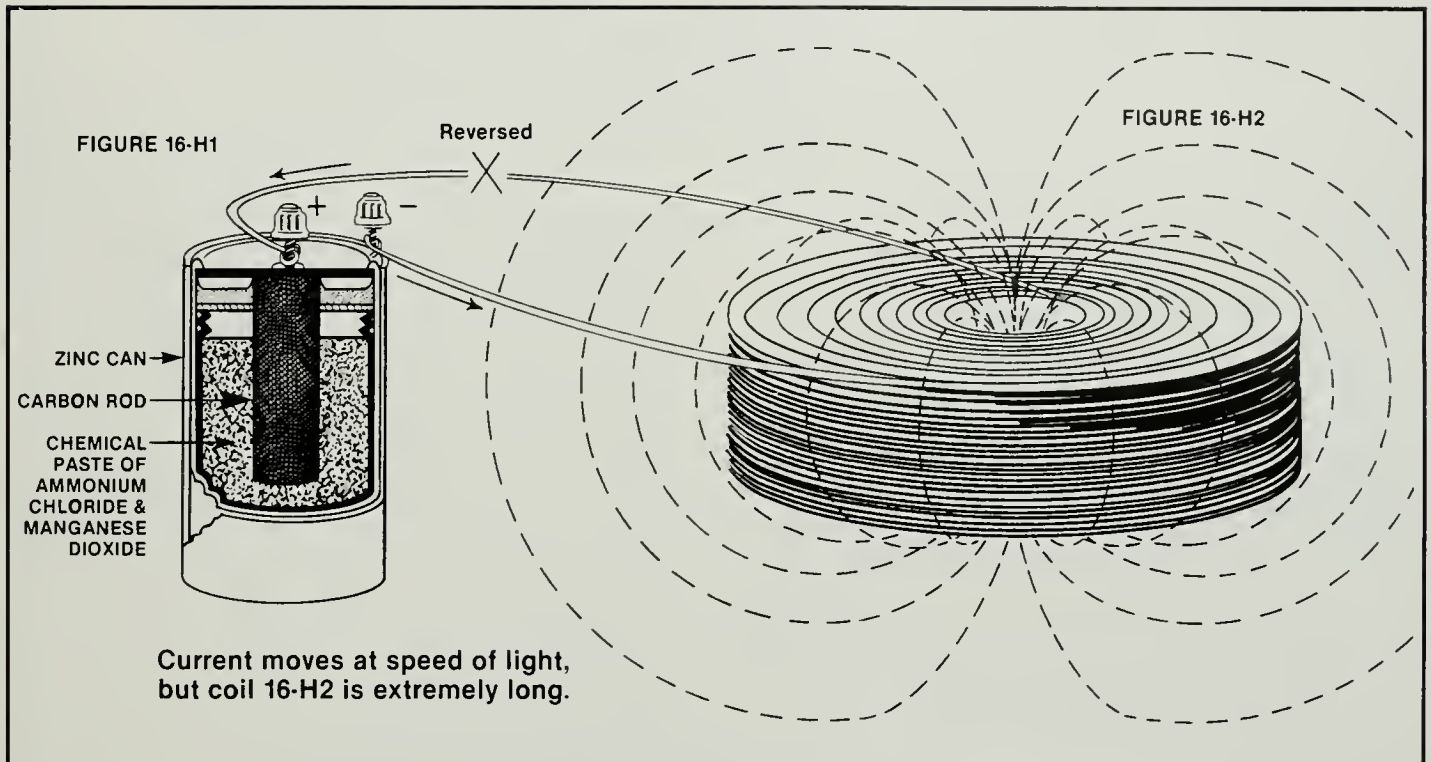

Re-examine the coil in Figure 15-B and then compare it to that in 16-H1 and 16-H2 above. Envision that if coil 16-H2 is composed of 5-gauge copper wire with such a length that its resistance is 1,000,000 ohms and the battery voltage of 16-H1 is 1000 volts, then only 1 milliamp of current could flow through coil 16-H2 and complete the circuit to return to battery 16-H1. It is obvious that the energy within the magnetic field of coil 16-H2 would be tremendous, and, if the direction of the current was reversed by a commutator (or similar mechanism) at position (X) above, *before* the current of 1 M.A. passed through the coil, then *no decomposition of the battery by chemical means would occur.* However, the *hydraulic effect* of the 1000 volts from battery 16-H1 would have already affected (catalytic effect) and aligned many atoms within coil 16-H2. Such alignment would generate a tremendous magnetic field (gyroscopic particles). When the current was reversed within coil 16-H2 by the pressure of 1000 volts from battery 16-H1, the in-

duced via $E = MC^2$ as energy is removed from the system. However, due to the high *conversion efficiency* within the process, it would actually require an extremely long period of time — measured in years — to significantly deplete the mass of the materials involved in the system.

It should be obvious to you that the electric current (gyroscopic particles) which emanates from the elements of battery 16-H1 is not depleted in coil 16-H2. If permitted, not only would the battery input current align the atoms of coil 16-H2, but once the current returns to the battery, such current would, according to Faraday's First Law, chemically decompose large quantities of matter compared to the minute size of the current (in the form of gyroscopic particles) which activates the undesirable chemical reaction.

These gyroscopic particles obey the First Law of Thermodynamics precisely: ***it appears they cannot be destroyed and it appears they possess a motion of infinite duration.***

17. You, the reader, must now obtain the proper perspective within your mind. (See Figures 17-A and 17-B.)

an electrolytic basis. Rather, what occurs is action according to $E = MC^2$ via the efficient conversion of *magnetic mass* (gyroscopic particles traveling

FIGURE 17-A

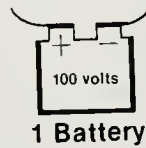

8 Batteries in Series

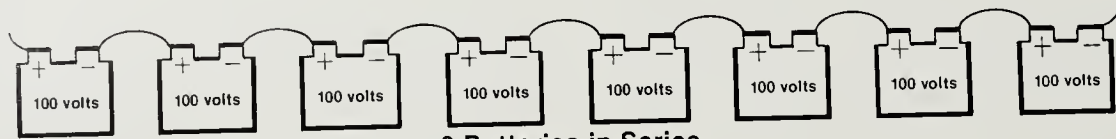

FIGURE 17-B

What distinction do you instantly detect between Figures 17-A and 17-B? You should recognize that one obtains greater energy from 17-B than from 17-A. You should recognize this fact on a chemical basis. However, you should also see that this distinction between Figures 17-A and 17-B can also be visualized according to $E = MC^2$ if properly understood and utilized.

Now examine Figures 17-C and 17-D:

throughout the space surrounding aligned atoms — also referred to as “magnetic energy”) to *electrical energy* (gyroscopic particles traveling through a conductor)*. If the technical system is properly utilized, one should not be surprised that an energy output can be achieved which is in excess of the external energy input. Consequently, one should instantly recognize that one can obtain greater energy from coil 17-D than from coil 17-C.

FIGURE 17-C



.01 lb. of 40-gauge copper wire

FIGURE 17-D

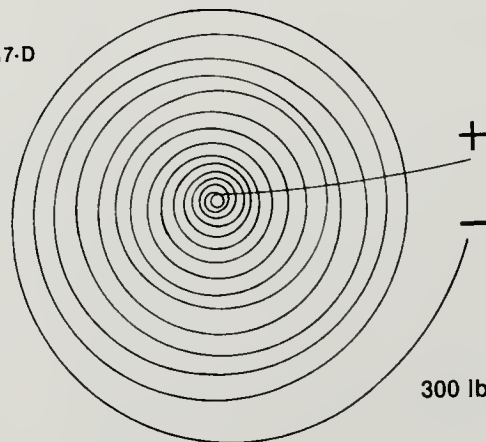

300 lbs. of 40-gauge copper wire

What difference do you recognize between Figures 17-C and 17-D? You should immediately recognize that there are 30,000 times *more* atoms in Figure 17-D than in 17-C. And you should also recognize that these atoms are — in effect — extremely small batteries (see Figures 17-A and 17-B above), except that there is *no* chemical reaction on

* *Note:* referring to energy as “electrical” or “magnetic” without understanding the essential nature of such energy can be conceptually misleading. There exists only *one* (mechanical) concept of energy: *gyroscopic particles in motion*. This single concept of energy can be observationally manifested in different forms: when traveling through a conductor (metal wire), the gyroscopic particles are commonly called “electrical” energy. When traveling throughout the space surrounding aligned atoms, the same gyroscopic particles are perceived as “magnetic” energy.

If one calculates the resistance in Figure 17-D compared to that of Figure 17-C, one finds the resistance of 17-D to be approximately 30,000 times the resistance of 17-C. Note that this fact coincides with my previous statement that the conducting coil 17-D contains 30,000 times more atoms than conducting coil 17-C.

However, to greatly increase the desired results, return to tests 15-A and 15-B. You will find in those tests that the resistance in 15-B is equal to that of 15-A, but within the coils of these two tests the number of atoms in each vary greatly. This difference is due to the fact that conducting coil 15-B has a phenomenal 110,704,968 times more atoms than conducting coil 15-A.

What is significant in Figure 18-A is the fact that when the small cylinder of niobium-tin alloy is removed from the liquid helium, the alloy instantly loses its formidable, magnetic field.

The reader should quickly recognize that in test 18-A, the niobium-tin alloy initially possessed energy (heat) which was removed from its mass when placed in liquid helium. This heat loss instantly results in a large reduction of the random atom motion within the alloy and therefore a high percentage of the alloy's atoms then align to release some of their electromagnetic energy (gyroscopic particles) throughout the formidable, magnetic field created.

You can easily see that this cryogenic process is op-

“... for a given current input ... the most efficient conducting system design is one in which the greatest number of atoms within a coil are aligned by the given current (gyroscopic particle) input.”

18. *At this point, it should be clear that for a given current input (consisting of gyroscopic particles) from a battery, generator, etc., the most efficient conducting system design is one in which the greatest number of atoms within a coil are aligned by the given current (gyroscopic particle) input.*

It is therefore obvious that a properly designed, super-conducting system would produce even greater results. As of this writing, work is being performed by other scientists in an attempt to develop a super-conducting material which can operate at temperatures higher than those previously developed.

A. Let us examine super-conducting magnets in view of what I teach. In Figure 18-A, when a small, fist-sized cylinder of niobium-tin alloy is placed in a flask of liquid helium having little or no current input, the cylinder becomes a formidable magnet of 24,000 gauss. Additional materials have been developed that are capable of producing superior results.

posite to the Curie temperature effect of heat input (energy) into a permanent magnet resulting in atom unalignment, i.e., increased random atom motion, and virtual disappearance of the magnet's field. (See Figure 12-D2 on page 9 for comparison.)

If the small, cylindrical, niobium-tin alloy is removed from the liquid helium, then heat (energy) travels into its mass from the environment which results in a significant increase in the random motion of the atoms within its mass. *This action creates the disappearance of the magnet's prior magnetic field since the gyroscopic particles which previously composed the magnetic field have now returned into the original atoms from which they came.* [These results scientifically match those of test 12-D above.]

“... I stress that it is essential that one design and establish the correct geometric configuration.”

19. *For optimal results, I stress that it is essential that one design and establish the correct geometric configuration! With such a correct configuration, the atoms of the substances involved will intersect the gyroscopic particles (composing the magnetic field of the system) at the proper angle. In some designs it may be desirable that those atoms within the system do not (or minimally) intersect the gyroscopic particles, i.e., in such instances, only gyroscopic particles should mechanically interact with one another.*

“One must pay strict attention to the mechanical essence of the gyroscopic action of these particles ...”

One must pay strict attention to the mechanical essence of the gyroscopic action of these particles

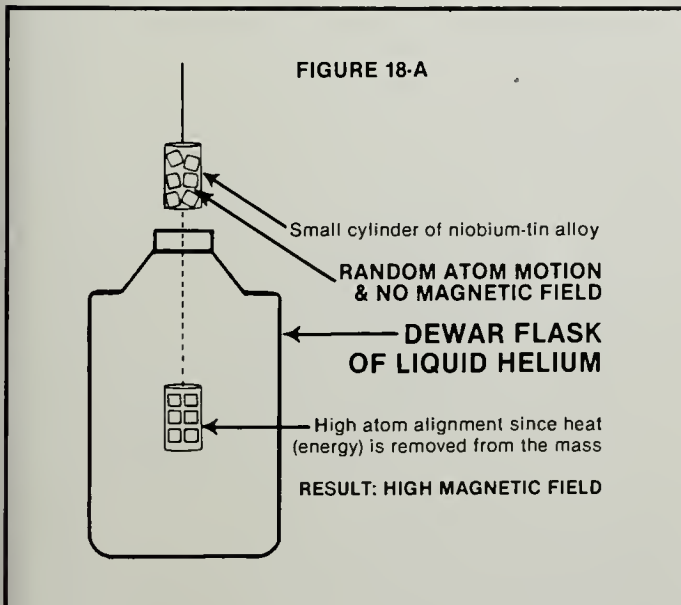

moving in a magnetic field and emanating from the atoms of the substances involved in the process. Such gyroscopic particles are the mechanical essence of the equation $E = MC^2$. (See Figure 19-A.)

FIGURE 19-A

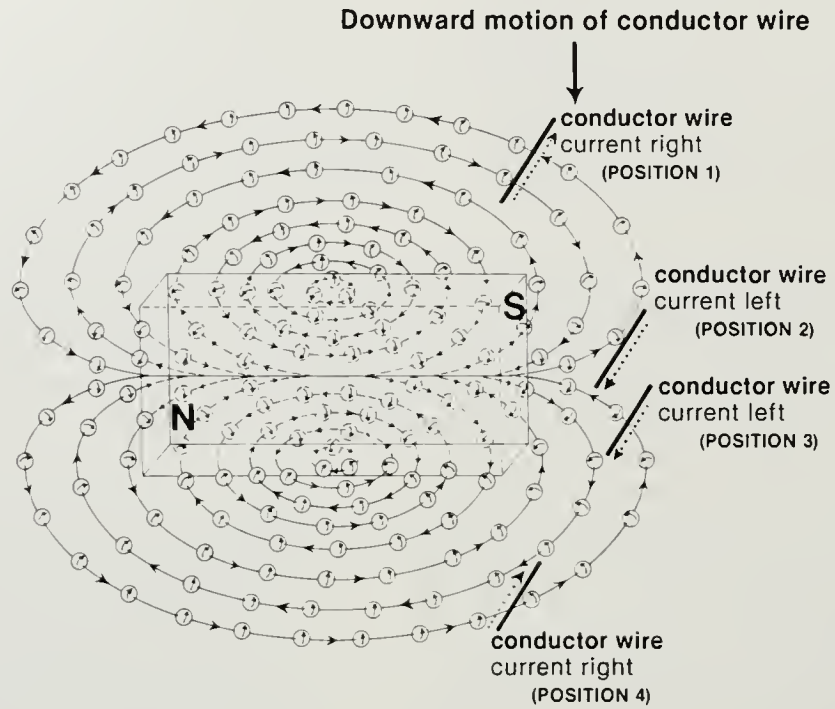

When a conductor is physically moved down and across a magnetic field as in Figure 19-A, then the current will change direction *twice*. The same is true if the conductor is moved from the South end of a magnet to the North end of the magnet. *Reason:* the direction of gyroscopic action is changing throughout the "lines (shells) of force." However, if a small, multi-looped, 38-gauge conducting-coil-wire [approximately 11/32-inch in diameter and 3/4-inch long] is moved across the end of a 6-inch diameter magnet, the current direction will alter *four* times. (See Figure 19-B.)

FIGURE 19-B

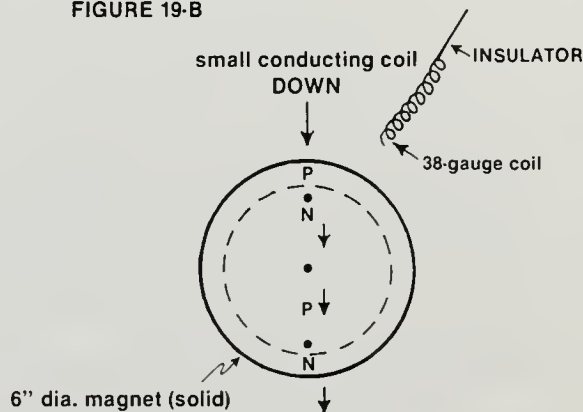
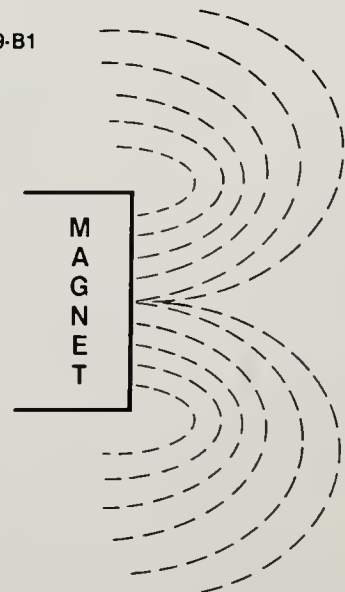

FIGURE 19-B1



By moving the 38-gauge, copper-wire coil across the end of the magnet (as shown in Figure 19-B), the current direction will now change *four times*. [P = positive and N = negative.] It is extremely important to recognize that the “lines (shells) of force” (gyroscopic particles) continuously vary in their exact direction at any given moment. Study Figure 19-B1 above and observe that the angular direction of the “lines (shells) of force” (gyroscopic particles) vary from the center of the magnet to the *left*, in one plane of the magnetic field, and to the *right*, in the opposite side of that same plane.

Also observe that at the points marked with a dot (•) in Figure 19-B above, there is no current produced even though the moving, small coil is never parallel with the “lines (shells) of force.” *Reason:* This occurs as a result of a *cancellation effect*, *i.e.*, one side of the small coil is located within one plane of gyroscopic particles possessing a given angular direction, while the opposite side of the small coil will be located in another plane of gyroscopic particles possessing a different angular direction. The identical effect will be observed if the small coil is moved from the North to the South end of the magnet.

The reader should understand that I did not observe the above results by accident. On the contrary. I utilized the small diameter coil because I expected that it would more effectively detect the varying angles of the gyroscopic particles involved. The results I obtained totally corroborated my expectations. It should now be obvious to you that relative to a magnetic field, the angular directions of the gyroscopic particles are of extreme importance with respect to a substance's given geometric design.

I would anticipate that computer technology — which is pictorially capable of depicting the mechanical essence of the action/reaction, gyroscopic effect of energies — would be very helpful in predicting more efficient designs and in computing useful mathematical formulas.

What should *not* be done is for one to simply “throw together” some design concept and then place it in a magnetic field without giving careful consideration to the mechanical essence of the energy of that magnetic field, *i.e.*, the mechanical essence of the energy (in the form of gyroscopic particles) comprising the atoms of the substance or substances of the design. Prior to my work, a lack of mechanical thought has been the norm, and, as the reader is well aware, the progress of science and the human race has suffered.

I stress to you, the reader, that there are *many* designs which will effectively release the energy in a magnetic field in accordance with the conversion of the mass from which the magnetic field emanates via $E = MC^2$.

The electromagnetic composition of the atoms of materials which initiates an input current flow is constant, is similar to hydraulic pressure, and appears to move at the speed of light. In addition, such input current behaves *solely* as a *catalyst* in interacting with the electromagnetic nature of the atoms comprising other

materials and caused such atoms to release a portion of their electromagnetic energy in the form of a magnetic field composed of gyroscopic particles. Such action increases the capacity of the system for performing “Obvious” or “Unobvious” Work, Force, or Power. The system can then react with another magnetic force or the atoms (gyroscopic particles) of that source to multiply this electromagnetic effect even further.

20. Let's examine the facts which corroborate the previous statement:

20

A. I have already proven that the greater the number of atoms aligned within a magnet, the greater the release of the magnet's energy (gyroscopic particles) in accordance with the equation $E = MC^2$. (See Figures 20-A1, 20-A2, and 20-A3.)

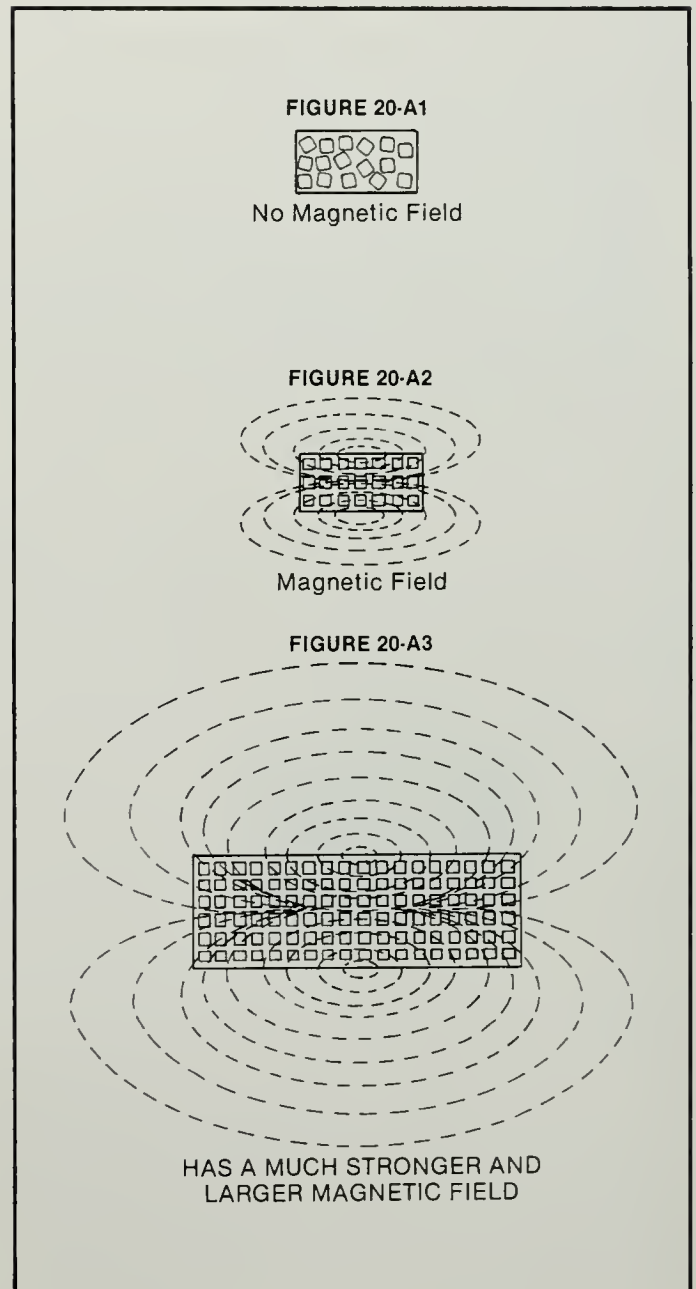

B. I have already proven that the more atoms aligned within a conductor, the greater will be the release of the energy contained within that conductor (in the form of gyroscopic particles) in accordance with the equation $E = MC^2$. (See Figures 20-B1, 20-B2, and 20-B3.)

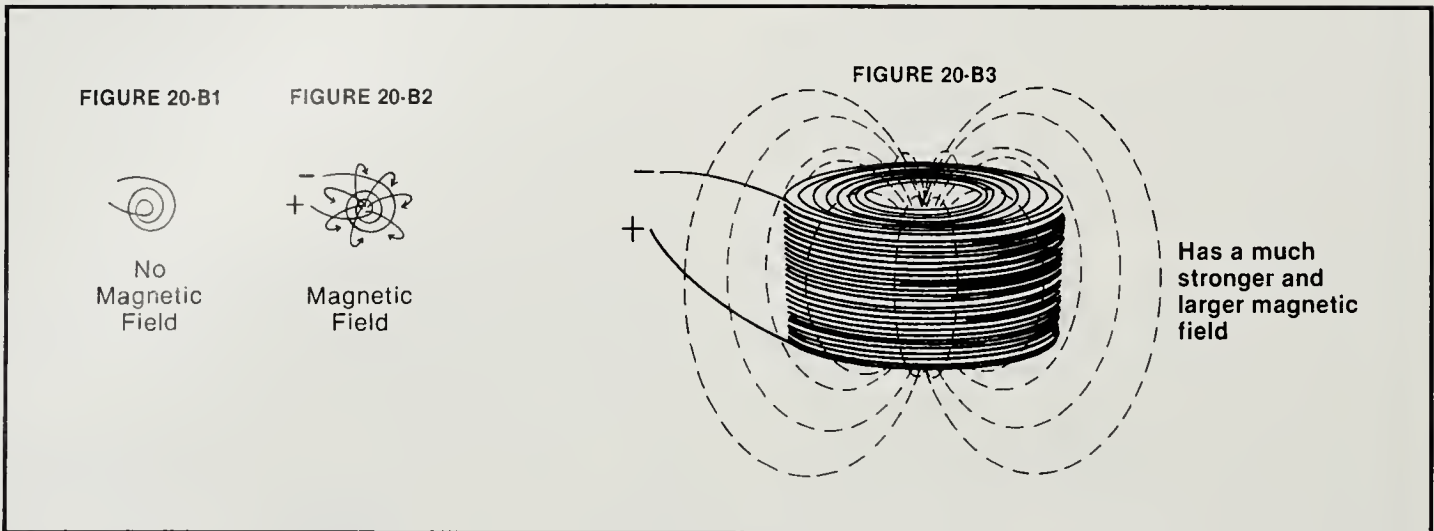

C. I have already proven that one should perceive the individual atoms (of Figures 20-A3 and 20-B3) as microscopic batteries with an energy capacity equivalent to $E = MC^2$. Realizing these facts, one then knows that the greater the number of atoms of any substance which one activates in accordance with these teachings, then the greater the energy release that can be expected. (See Figures 20-A3 and 20-B3.)

Refer back to Figure 15-B (on page 19) and imagine that Figure 20-B3 is of similar magnitude. Also, imagine Figure 20-A3 of proportional size and magnitude with Figure 20-B3. If these two systems (20-A3 and 20-B3) then react with one another, you will obtain the following: (See Figures 20-C1 and 20-C2.)

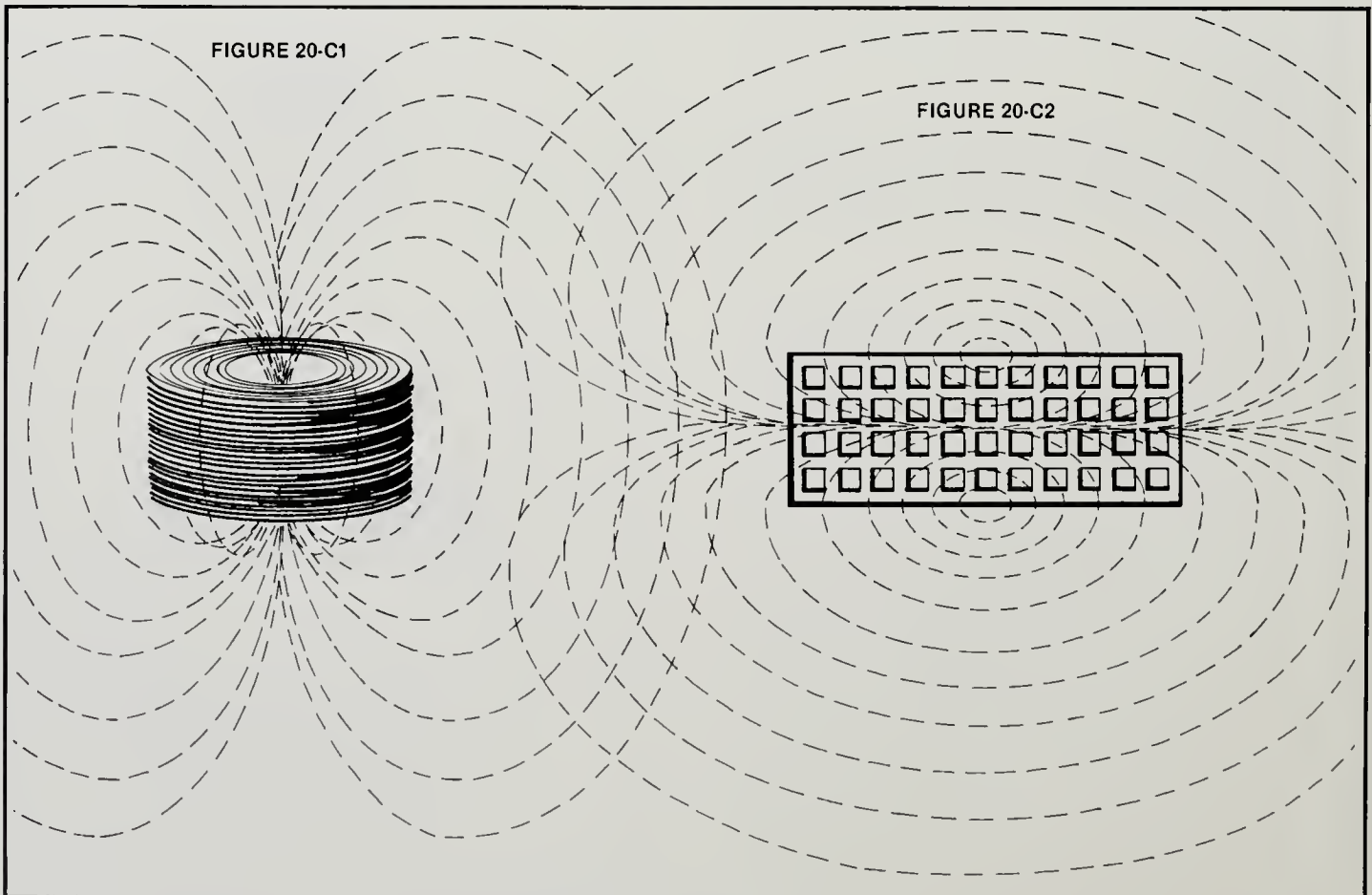

One can easily envision a conductor coil 20-C1 being the size of a domed stadium, and a magnet 20-C2 being larger than a giant redwood tree.

In some cases, it may be desirable to permit the gyroscopic particles emanating from magnet 20-C2 to efficiently interact with the gyroscopic particles surrounding the conducting coil 20-C1, but *not* to interact with the atoms contained within the conducting coil 20-C1 itself. With the proper mechanical configuration utilizing the gyroscopic particles, one would achieve maximum torque with magnet 20-C2 without creating back-emf or induction into conducting coil 20-C1.

The reader must also realize that there is a hydraulic, "magnetic-coupling effect" of the gyroscopic particles comprising the magnetic fields — an effect which extends back to the atoms of the material from which the gyroscopic particles emanate. *As a result, the Archimedian "Laws of Leverage" are enacted!*

Knowing these facts, one can easily see that in Figures 20-C1 and 20-C2 there would be a phenomenal torque produced upon the masses of *both* 20-C1 and 20-C2. *This phenomenal torque is the result of $E = MC^2$!*

²⁰
D. EXAMINE THESE FACTS: The massive number of atoms within conducting coil 20-C1 produce a phenomenal back-emf (power) which is greater than the *external energy input* (consisting of a catalytic effect only) or external power input. In addition, the massive number of atoms within magnet 20-C2 release via atom alignment a large quantity of kinetic energy (in the form of a magnetic field) which interacts with another large quantity of kinetic energy (in the form

results described above were observed in the primitive prototype (described in 15-C and 15-C1) except that the generating coil had only 300 lbs. of atoms. For more impressive results, the prototype should have contained 4,200 lbs. of atoms. I specifically limited the coil weight to 300 lbs., however, because I knew that high voltage would occur and that electrical-resistance-breakdown could also happen if the coil size became too great. These problems are technical problems which can easily be solved by present technology.

The reader should clearly understand by now that if the electric current which is initially released from a battery is not permitted (by a conducting coil) to complete the circuit within the coil itself, then the total electromagnetic energy (gyroscopic particles) contained within the conducting coil will perform exactly as I teach. Ideally, one should construct the energy machine to have voltage (hydraulic pressure), but the input current should (as much as practical) be prevented from returning to the battery, generator, etc. That current which flows from the conducting coil could indeed return to the battery and re-charge it.

²⁰
E. One could reduce the length of a conductor and still achieve the desired results by simply increasing the speed of the "on" and "off" input current which behaves as a pulsating flow. The atoms of the conductor will produce a back-emf flow as a result of the expanding and collapsing magnetic field (composed of gyroscopic particles). These atoms are "triggered" into this observable, back-emf flow via the "catalytic" action of the small, initial input current.

"The greater the voltage (hydraulic pressure), then the greater the number of atoms of a conductor will be triggered into the desired action."

of a magnetic field) within conducting coil 20-C1. Such interactions result in a phenomenal torque effect and either 20-C1 or 20-C2 (or both) could rotate.

Observe that the above mechanical configuration has multiplied the capacity of the system to perform "Obvious" or "Unobvious" Work, Force, or Power relative to the initial power input which acts only as a catalyst.

Now, envision another conducting coil of proportional size which acts as a generator and is physically positioned to efficiently interact mechanically with 20-C1 and 20-C2. This configuration will increase the energy output even further.

Such a configuration is exactly what I created with my primitive, handmade prototype. The prototype was not built for *my* benefit, but for the benefit of others who had been unjustly influenced by a teaching process which rewards memorization. It was also built for those who could not or would not recognize the validity of my Theoretical Process. (Again I refer to the discussion in 15-C and Figure 15-C1.) All of the

The greater the voltage (hydraulic pressure), then the greater the number of atoms of a conductor which will be triggered into the desired action. However, this statement should be qualified: the facts indicate that all atoms have a "threshold effect." If the "threshold effect" of the atoms (contained within a given diameter and length of a conductor) are exceeded, then the atoms will emit some of their electromagnetic composition (gyroscopic particles) in the form of heat with the result that the magnetic field would be greatly reduced. If this occurs, then one should simply increase the diameter of the conductor or increase the speed of the pulsating input current.

Returning to the prototype in Figure 15-C1: this massive 5-gauge coil had only eight (8) ohms of resistance, yet it produced a tremendous back-emf (power) which reduced current-flow-input from the battery pack. When the input power from the battery pack was interrupted, the back-emf then returned more power than the original power input from the battery pack.

21. There are those individuals who will ask the question: "Why can't one simply feed the generated, output current back into itself, eliminating the need for an input battery?" The answer is simple: The energy involved in this system (consisting of gyroscopic particles) is composed of real, mechanical entities which will work against themselves [as would unaligned gears] just as readily as they will work together in utilizing or generating power. (See Figure 21-A.)

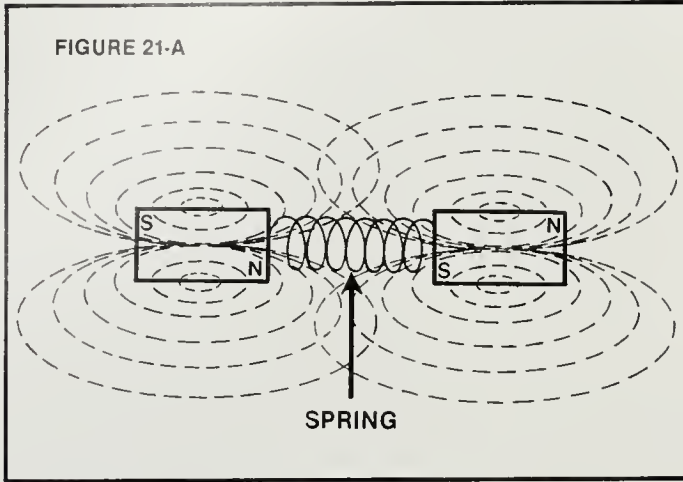

A. Envision that the above two magnets in Figure 21-A have a strong, magnetic field that is capable of compressing the spring. One would not expect the spring to then recoil and push the two magnets apart. *Reason:* The gyroscopic particles emanating from the atoms of the two magnets are the mechanical essence of $E = MC^2$ and, consequently, such particles will keep the spring compressed. However, if one has a "triggering mechanism" or a catalytic effect that causes the atoms of one or both of the two magnets to align and unalign, then the spring would recoil, pushing the two masses apart. When the atoms are aligned, the spring would again be compressed via the generation of the magnetic field by the aligned atoms. This process would continue to repeat itself.

B. A similar effect (created by the gyroscopic particles via $E = MC^2$) is observed when the current is prohibited from returning to a conventional generator. If a mechanical means is constructed to "trap" the electric current and prevent it from completing a circuit, then the gyroscopic particles of the current have a capacity for continuous work without the necessity to increase the power input from the generator system. However, if the circuit is complete and the electric current moving within the system performs no "Obvious" Work, Force, or Power, then the gyroscopic particles comprising the current will — upon returning to the generator — increase the need for greater power input into the system. *Reason:* Such action occurs as a result of the very fact that these gyroscopic particles are literally the "mechanical essence of $E = MC^2$ " and it appears they cannot be destroyed. This fact results in these gyroscopic par-

ticles having a "cumulative effect." (See Figure 21-B1 and Figure 21-B2.)

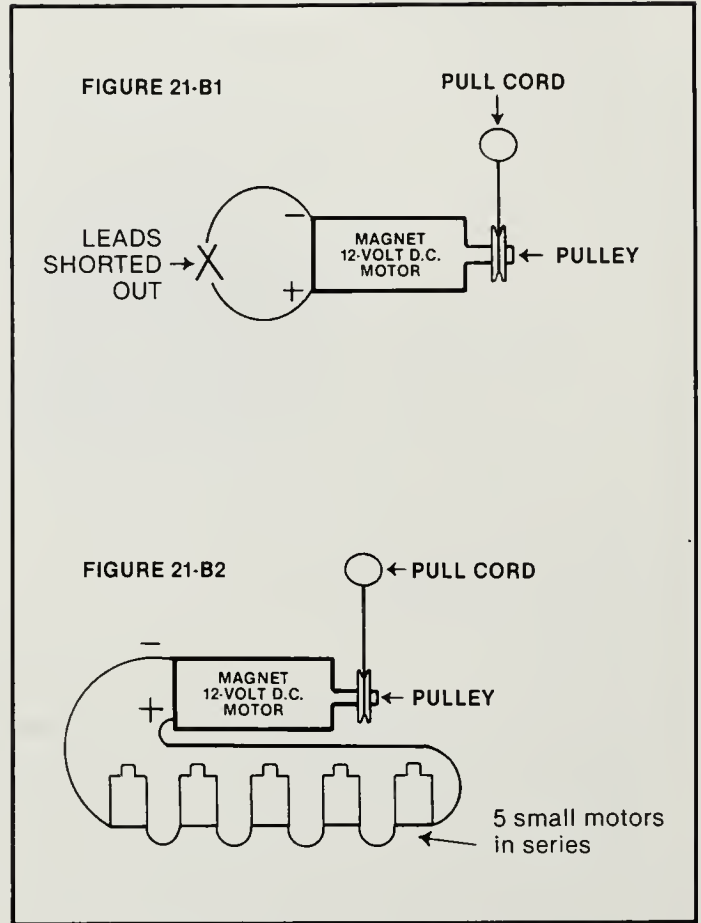

In Figures 21-B1 and 21-B2, the depicted motor also acts as a generator. In 21-B1, if the leads are shorted out with only 1 ohm of resistance in the generator's conductor, *there will be a resistive force equal to the pull-force* that one exerts in pulling the pull-cord attached to the pulley on the motor (generator) shaft. *Reason:* The conductor cuts the magnetic field of the permanent magnets, thereby releasing gyroscopic particles (current) from the magnetic field. *These releas-*

"This successive number of gyroscopic-particle-releases is what creates the 'cumulative effect.'"

ed, gyroscopic particles which travel into the conductor then have their spin at right angles to the balance of gyroscopic particles (spin) remaining in the magnetic field which in turn generates an opposing "Obvious Force." These gyroscopic particles continue to move throughout the shorted conductor as the conductor continually moves through additional "lines (shells) of force" within the magnetic field which, in turn, results in even more gyroscopic particles (current) being released within the conductor. This successive number of gyroscopic-particle-releases is what creates the "cumulative effect."

One can easily prove this previous statement to be a fact by simply conducting an experiment. Observe that the harder one pulls on the “pull-cord” (in Figure 21-B1), the more the resistive force will equal your pull. [Frictional force is additional.] *One can therefore easily observe that one is producing no “Obvious Work, Force, or Power” outside the system.*

Observe above Figure 21-B in which five smaller, permanent-magnet motors have been placed in series. When one pulls the pull-cord, one finds that the required energy is significantly less than in Figure 21-B1 and yet all five additional motors will now be running. *One is now producing “Obvious Work, Force, and Power” outside of the system and yet one is using significantly less input power.* Why the difference? *Answer:* In Figure 21-B1, one is producing high current (volume of gyroscopic particles which acts as a “brake”) and virtually no hydraulic pressure (voltage). However, in Figure 21-B2, one is producing high hydraulic pressure (voltage) and low current (volume of gyroscopic particles completing the circuit), therefore, the “braking effect” is drastically reduced.

Lenz’s Law states that “the current induced in a circuit due to a change in the magnetic flux through it or to its motion in a magnetic field is so directed as to oppose the change in flux or to exert a mechanical force opposing the motion.”

Lenz’s Law is simply an observation of this cumulative effect of the gyroscopic-particle-spin (comprising the current produced) being at right angles to the spin of the gyroscopic particles remaining in the magnetic field. Prior to my work, the true nature of the magnetic field has never been fully understood.

Returning to the question, “Why can’t one simply feed the generated, output current back into itself?” I would answer: **If one blindly (via mechanical implicitness) feeds the current produced from a system back into itself, then a “braking effect” will occur which will negate the desired results.**

It should be obvious to the reader that the prior teachings have indicated that all power produced from any type of conducting system was the result of current flow and was not from the conducting system itself. As a result of this view, all prior systems have been deliberately designed to utilize high current-flow to produce high power.

If you have mastered my teachings up to this point, then you should be principally interested in the *voltage* (hydraulic pressure), since the current (gyroscopic particles) simply acts as a catalyst for any system into which it flows. As I indicated above, the gyroscopic particle composition of the current *cannot be depleted* as it moves through the system. As a result, the current completes the circuit to the generator and a “braking-action” occurs to create the *cumulative effect*. If the current was to complete the circuit and return to the battery, then such current would, according to Faraday’s Law of Electrolysis (which depends upon current flow [gyroscopic particles]),

produce an undesired chemical action and destroy one’s ability to utilize the elements of the battery in accordance with $E = MC^2$.

The very electrolytic action described by Faraday’s Law is proof that the current within the system has not been depleted. With a correct technical system, such current could be harnessed for more productive purposes since the gyroscopic particles (which comprise the current) have an infinite capacity for work.

Via the proper design, it is obvious that one can feed the energy triggered and released from a system into a configuration which then operates itself and produces additional, excess energy in accordance with $E = MC^2$ by converting the mass of the system involved.

This is exactly what I have clearly demonstrated by utilizing the primitive, handmade prototypes already discussed. (See Figures 15-C1 and 15-C2.) There are many additional, technical designs possible which will be built by following my basic principles.

22. I now wish to give you, the reader, a test. Have you understood literally what I have taught you? Or have you simply sought to memorize what I have written? **I wish to stimulate you to understand the very “essence” of what I teach you!** Only by doing so will you be able to “stand on my shoulders and see farther than I have.”*

Question: How would you build a more efficient design than the primitive prototypes I have already demonstrated? What properties would you seek to perfect in your system?

You should understand that if built structurally strong, even the 15-C1 and 15-C2 prototypes would produce an impressive power output if the hydraulic pressure (voltage) was increased. For example, in the smaller 15-C2 unit, I utilized only 300 volts of pressure due to the fact that as one increases the voltage (hydraulic pressure) then the power produced becomes damaging to the primitive commutator which I built by hand. Utilizing these 300 volts, I had only 1.6 milliamps input and a 14 lb. magnet which rotated at approximately 200 RPM. Now, if you add 100,000 volts (hydraulic pressure) to a system structurally designed to withstand the voltage — which is 333 times the original voltage I utilized to demonstrate my correct principle — then one can expect the power output to be in thousands of watts with an input of only several hundred watts. With such a system, the 14 lb. magnet would rotate at more than 50,000 RPM!

What I continually stress to you, the reader, is that the handmade prototypes were simply built to prove that the Technical Process which I teach is correct. *I consider the Technical (Theoretical) Process to be 10,000 times more important than those primitive prototypes.* If you have mastered what I teach, then the magnitude of this “Pioneering Invention” should be obvious to you.

* Based upon the quotation from Isaac Newton: “If I have seen farther than others, it is because I have stood on the shoulders of giants.”

Chapter 9

EXPLANATION OF INTERNAL ACTION WITHIN MY ENERGY MACHINE AND DISCUSSION OF COMMUTATOR DESIGNS

"If you cannot make something simple, in the end you do not know what you are about."

— Dr. Edward de Bono

²²
A. QUESTION: Do you understand the importance of physically designing a technical configuration which causes the current (consisting of gyrosopic particles) to be "trapped" within any system (including a conductor) utilizing the hydraulic pressure (voltage) of the input current and prohibiting such input current from detrimentally affecting the battery source of the input current? [If permitted (to a detrimental extent) to return to the battery source, such input current will operationally invoke Faraday's Law of Electrolysis and prevent the further utilization of the electrical energy (gyrosopic particles) within the battery in accordance with Einstein's equation of $E = MC^2$.]

²²
B. QUESTION: Do you understand that the gyrosopic particles (current) emanating from the materials of a battery literally represent the mechanical essence of Einstein's equation of $E = MC^2$ and constitute the basic entities comprising all component parts (other

and larger sub-atomic particles *e.g.*, electron, proton, neutron, meson, neutrino, quark, etc.) within the atoms of the materials used in the construction of the battery?

If you do not instantly know the answers to questions 22-A and 22-B, then you have not "Mastered" what I have taught, and you must therefore re-read (and Master) the earlier sections of this Book before proceeding further.

However, if you do know the answers to questions 22-A and 22-B, then you should immediately understand why I designed (within the structure of my invention) a *segmented* commutator and brush system for the purpose of proving 1) my teachings are correct and 2) how quickly production units for practical use will result when my teachings are "Mastered" and not "Memorized."

²²
C. EXAMPLE: (See Figure 2-C1.)

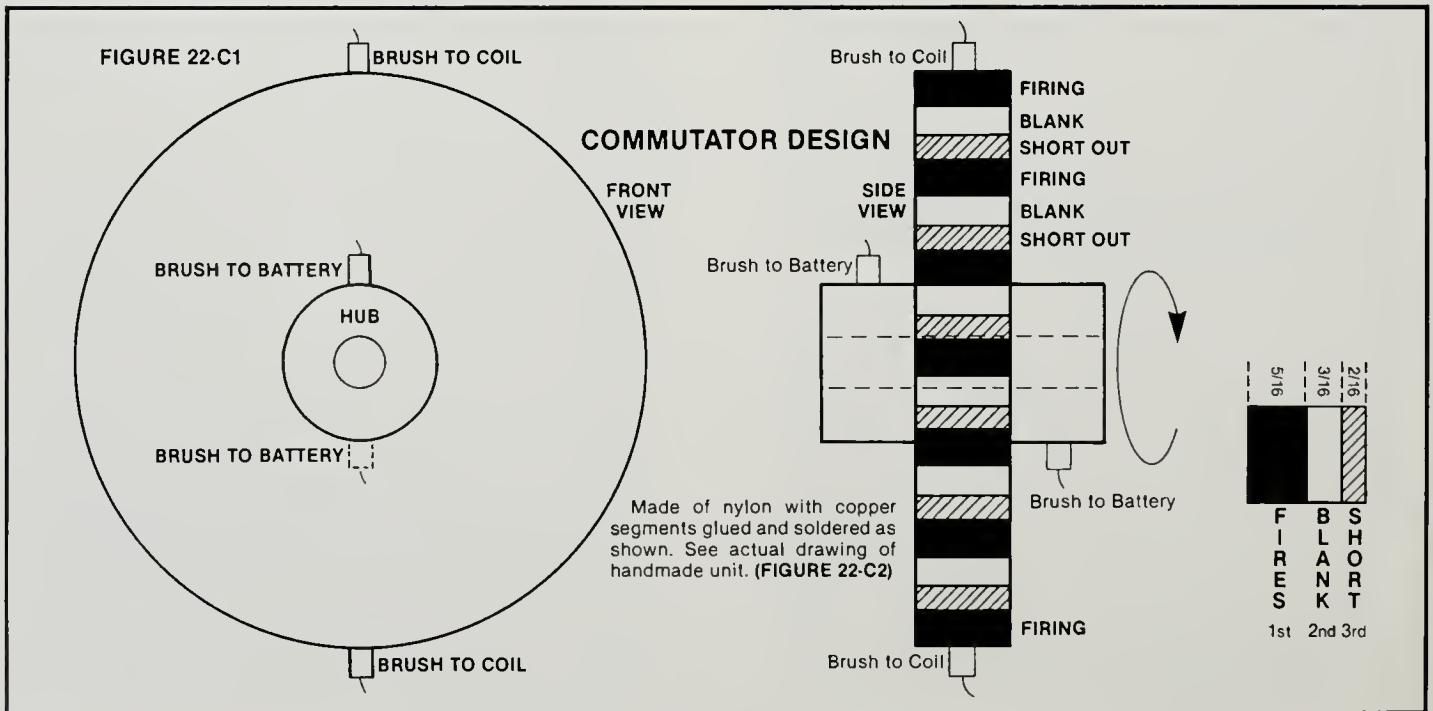
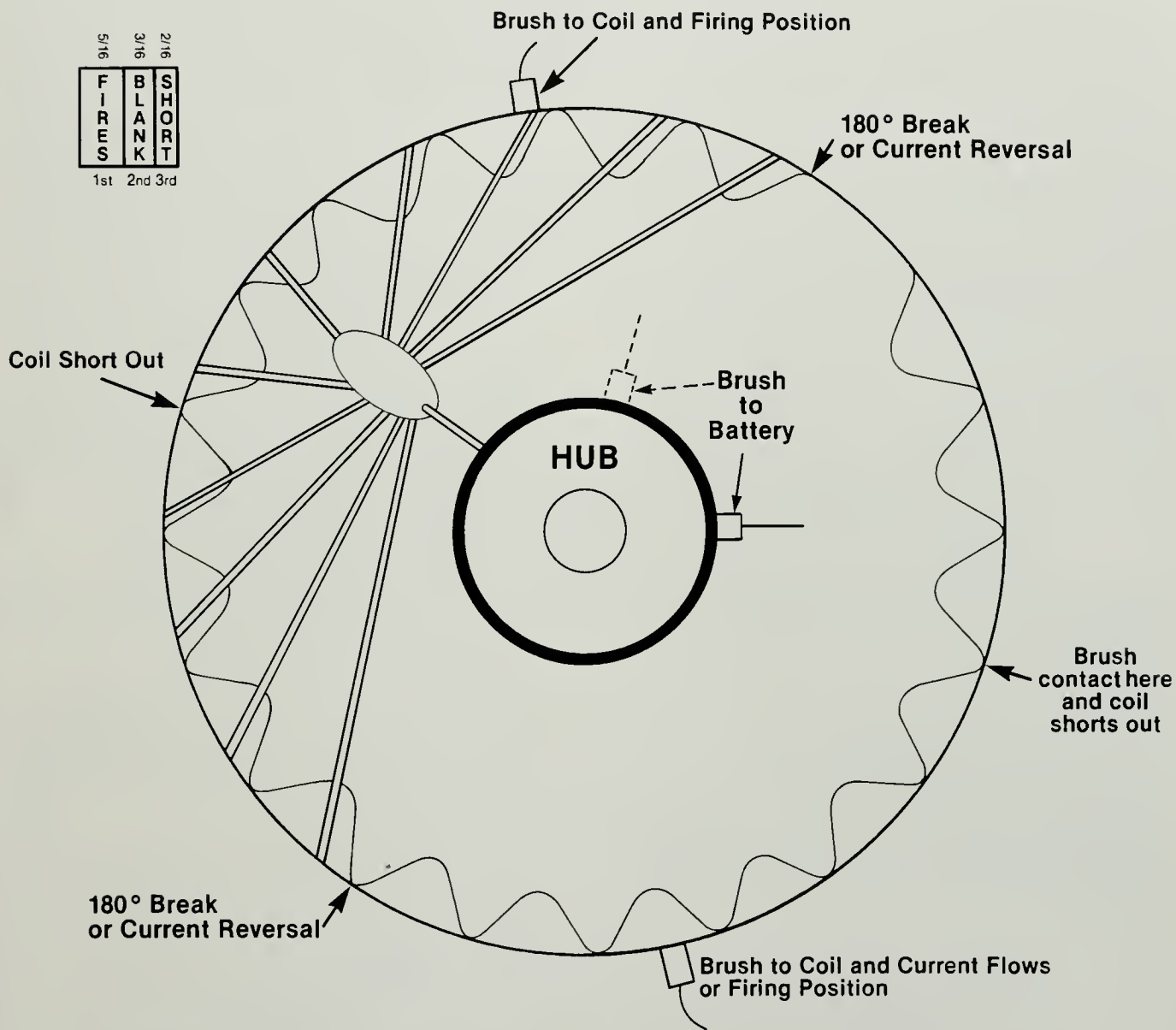

FIGURE 22-C2

Commutator has 20 Current Input or Firing Positions $5/16''$ wide, 20 Blank Spots $3/16''$ wide, and 20 Short Out Positions $2/16''$ wide.



Opposite side of Commutator is connected with Firing Wires to the Hub on the opposite side of the 180° Break. No Short Out Wire is needed on the reverse side.

D. QUESTION: Why does the commutator — at the points where it makes contact with the brushes connected to the copper coil — consist of *segments*? [Those hub or brush contacts connected to the battery interface with a *continuous* rim of copper.]

ANSWER: *Simple, if you have "Mastered" my teachings to this point.*

The brushes connected to the copper coil make contact with the FIRING SEGMENT position on the commutator. At that precise moment, current (in the form of gyroscopic particles) flows from the atoms of the battery's materials into the copper-coil conductor as a result of the "hydraulic effect" [voltage]. As a "catalytic effect," such current-flow from the battery causes some of the atoms (within the copper-coil conductor) to align and release a minute portion of their electromagnetic configuration (in the form of gyroscopic particles) to generate an expanding magnetic field. As a result, some of these gyroscopic particles (within the expanding magnetic field) mechanically collide with a portion of the gyroscopic particles comprising other atoms within the copper-coil conductor. Some of these gyroscopic particles collide at a right angle, and those that do subsequently move at a right angle to that right-angular force. Such right-angular motion results in electrical current (consisting of gyro-

remaining within the atoms of the conductor. This right-angular collision occurs in a direction opposite to the right-angular collision which originally occurred when the magnetic field was *expanding*. As a result of the second collision, additional electrical current (in the form of moving gyroscopic particles) is produced in the conductor. Such current is now moving in the same direction as the original, "catalytic" input current (gyroscopic particles) from the battery.

At the next instant in the rotation of the commutator, the brushes that are connected to the copper coil leave the BLANK SEGMENT and enter the SHORTOUT SEGMENT. This SHORTOUT SEGMENT permits the current (gyroscopic particles) produced by the collapsing magnetic field to complete the copper-coil conductor circuit, but prevents additional current input from the battery. Such electrical-circuit-completion within the copper-coil conductor works to maintain the magnetic field of the coil since the current (gyroscopic particles) circulation in the copper-coil conductor is in the *same direction* as the original, "catalytic" input current from the battery source. Such "magnetic-field maintenance" results in a continual force which acts in the proper direction to affect the rotating magnet adjacent to the copper-coil conductor, although the magnet and conductor are not limited to this position or configuration. Furthermore, such a continual force

"The power produced from the conducting coil within the system becomes significantly greater than the initial 'catalytic' power coming from the atoms of the materials comprising the external battery."

scopic particles) which moves in a direction opposite to the "catalytic" input current (gyroscopic particles) from the battery source. The electrical current (gyroscopic particles) generated by the above-mentioned, right-angular collisions essentially "traps" and prevents the battery current from completing the circuit. [Note: This right-angular motion of the gyroscopic particles occurs as an "after-the-fact" reaction, *i.e.*, the right-angular motion occurs *after* the gyroscopic particles (comprising the expanding, magnetic field) collide with those gyroscopic particles remaining within the atoms of the conductor.]

At the next instant in the rotation of the commutator, the brushes — connected to the copper coil — move off the FIRING SEGMENT and pass onto the BLANK SEGMENT (or "dead-spot" position.) This new position breaks the "hydraulic effect" (input voltage) from the battery and thereby causes the atoms of the copper-coil conductor to unalign. Such atomic unalignment results in a collapsing, magnetic field and represents an attempt on the part of the gyroscopic particles (comprising the magnetic field) to return into the atoms from which they originally emanated. When this occurs, some of these gyroscopic particles comprising the collapsing magnetic field then collide at a right angle with some of the gyroscopic particles

greatly reduces wasted energy (electrical sparking) at each current break in the commutator!

Following the SHORTOUT SEGMENT position, the brushes connected to the copper coil enter the FIRING SEGMENT position again, and the entire process is repeated twenty times per revolution of the rotating magnet since the commutator is attached to the shaft of the rotating magnet.

22

E. The electrical activity as described in section 22-D appears on an oscilloscope as depicted in the drawing below. (See Figure 22-E.)

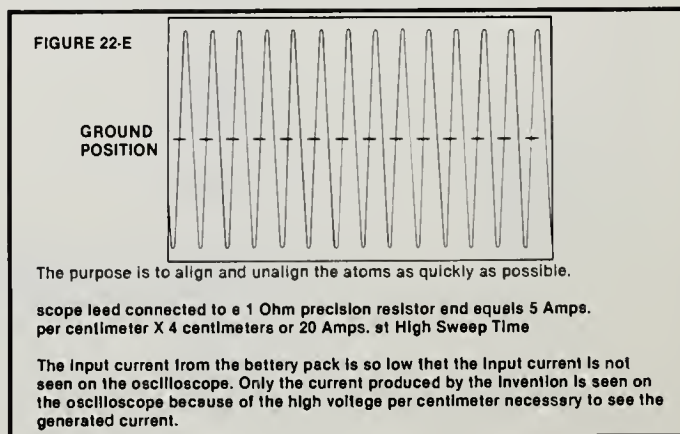

INTERACTION OF COIL STRUCTURE AND ROTATING, CYLINDRICAL, PERMANENT MAGNET

WIRE FROM BATTERY TERMINAL (-)

The expansion and collapse of the coil's magnetic field can also be considered independently of the cylindrical permanent magnet. In addition, the cylindrical permanent magnet could be placed inside the coil structure. If this is done, then to avoid a "cancellation effect" the width of the opening on the coil structure should **exceed** the end width of the cylindrical permanent magnet.

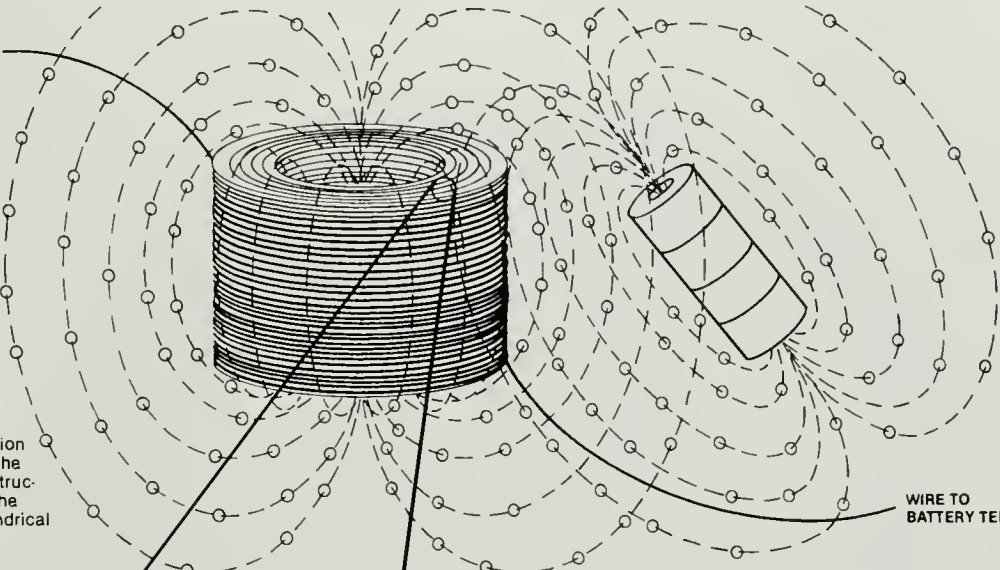
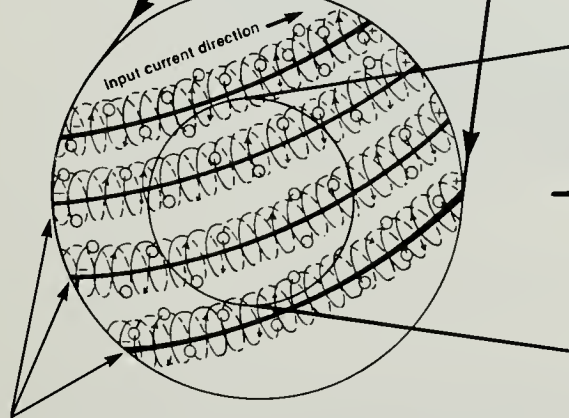

FIGURE 22-D

MAGNIFIED VIEW OF COPPER WIRES

TOP
(looking down from above)



spiral-helix path of gyroscopic particles (only a few depicted) which generate the magnetic field around the coil

1

"collision" occurs between the upper periphery of the gyroscopic particle and the adjacent copper wire

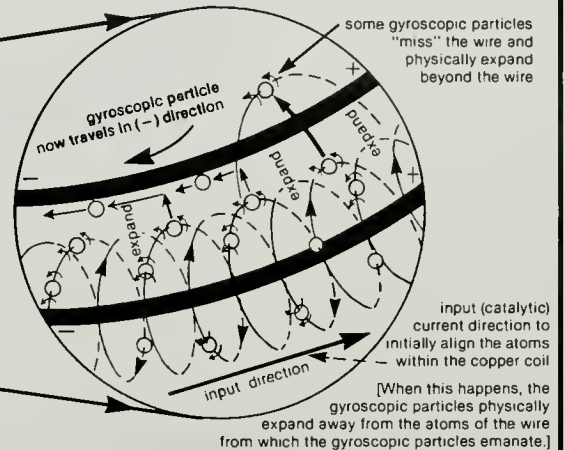

MOMENT OF FIRING SEGMENT ON THE COMMUTATOR

(expanding magnetic field)

2

now the gyroscopic particle "collapses" to return to the atom from which it emanated — but now the lower periphery of the gyroscopic particle first strikes the copper wire causing the gyroscopic particle to now travel in the (+) direction

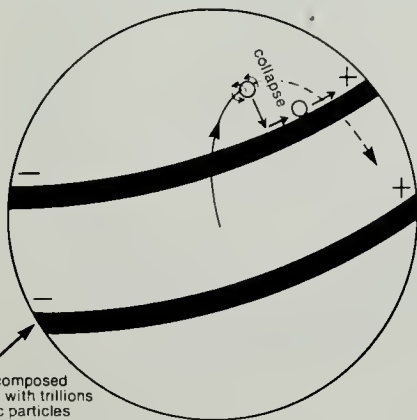

copper coil composed of copper atoms with trillions of gyroscopic particles

MOMENT OF BLANK SEGMENT ON THE COMMUTATOR

(collapsing magnetic field)

3

The process below is fully repeated with step 1 physically thrusting the expanding magnetic field even further beyond the coil structure. [This expansion and collapse of the coil's magnetic field mechanically interacts with the magnetic field (gyroscopic particles) of the cylindrical magnet to create a "push-pull" effect which causes the cylindrical magnet to rotate and also add some of its gyroscopic particles in interaction with the copper coil, thus adding further to the external output energy.]

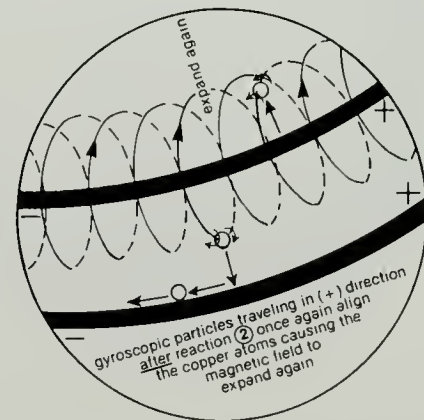

MOMENT OF SHORT OUT SEGMENT ON THE COMMUTATOR

(cancelling additional current from the battery)



PHOTO BY MATT ANDERSON

PHOTOGRAPHS OF COMMUTATORS

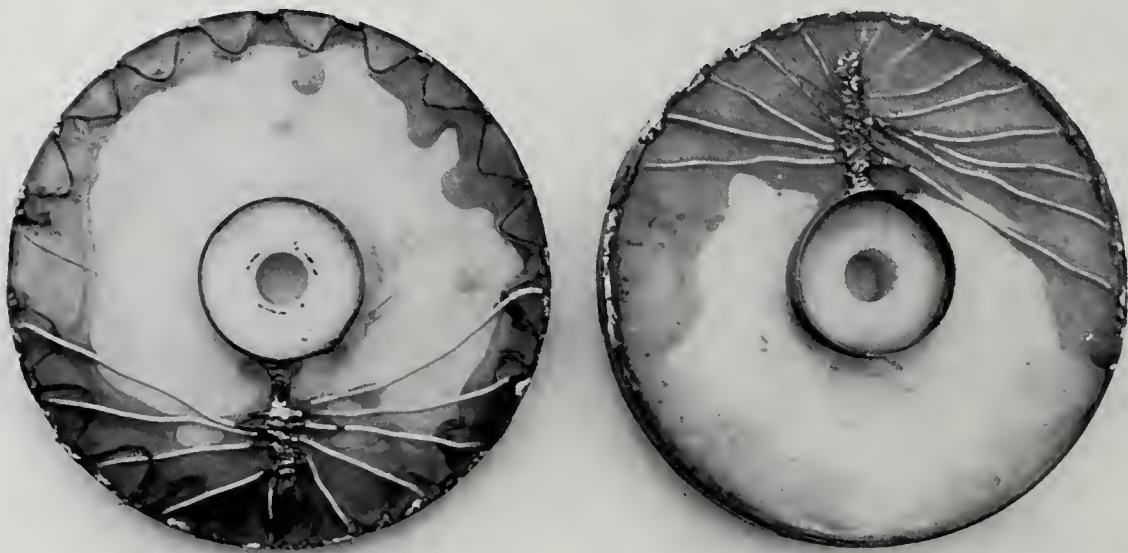

PHOTO BY MATT ANDERSON

The power produced from the conducting coil within the system becomes significantly greater than the initial "catalytic" power coming from the atoms of the materials comprising the external battery.

Observe that we have not created Power or Energy from nothing. The system I have innovated releases Power or Energy from the sub-atomic (gyroscopic particle) arrangement of the atoms comprising all materials (coil, battery and magnet) in accordance with Einstein's equation of $E = MC^2$. This process occurs on a 100% conversion-efficient basis.

²²
F. One must pay strict attention to the exacting Fact of the mechanical essence described by the above results. As the commutator revolves, the mechanical action which occurs within the atoms of the conductor coil should remind one of the timing sequence that occurs during the spark plug firing within an automobile engine. Just as the proper timing of such firing within the vehicle engine cannot be ignored or taken for granted, neither can the gyroscopic particles

"The 'timing effect' I have described is very critical."

(comprising and emanating from the atoms of the system's materials) be ignored or taken for granted in terms of their "firing" to generate the production of external energy output. When the sparking in piston firing is stopped, in the case of an automobile engine, this is analogous to properly timing the rotating commutator to stop the firing of Production as the coil brushes physically enter the BLANK SEGMENT position.

Anyone familiar with the conventional engine within an automobile knows that, if all pistons were "fired" simultaneously and continuously, there would be no rotational motion of the crankshaft. Under such circumstances, one would have only an "Unobvious Work, Force, or Power" produced in such an engine. The same effect is true (by what I have presented in the above discussion) when the atoms within the copper-coil conductor remain aligned at all times.

Under such circumstances, there would be no rotational motion on the part of the commutator (via the revolving magnet), nor would additional, external, electrical current (gyroscopic particles) be produced once the magnetic field of the copper-coil conductor ceased to expand and collapse. In essence, there would be only an "Unobvious Work, Force, or Power" produced.

In order to understand what I have written and to be able to physically construct those units capable of achieving what I have achieved, you must "Master" these teachings. The "timing effect" I have described is **very critical**. This "timing effect" will vary from the configuration of one physical system to another. **EXAMPLE:** The voltage (hydraulic effect) input, and the intensity of any interacting, additional magnetic

field(s) will all be critical considerations to the "timing effect" of any system's design.

To properly understand what I have written, you must "Master" the fact that we are mechanically discussing the "Mechanical essence" of $E = MC^2$.

²²
G. Return to Dr. Hasting's Affidavit of June 17, 1984 and study the oscillograph pictured on page 37. This oscillograph was produced via the utilization of a 14 lb. magnet *adjacent to* a copper coil (see Figure 22-G1). The current spike in Figure 22-G1a was produced from the copper coil.

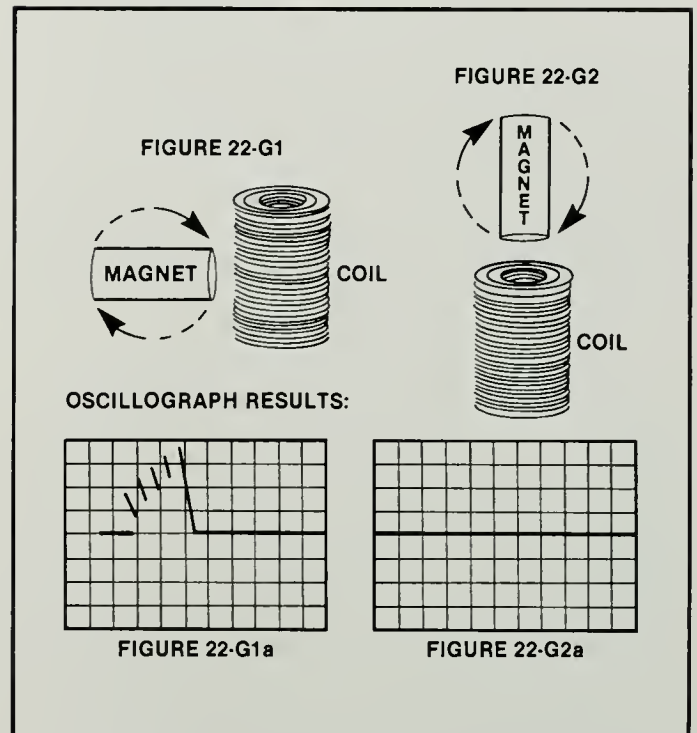

However, if the 14 lb. magnet was physically placed *above* the copper coil (as in Figure 22-G2), then no current spike (see Figure 22-G2a) was produced from the coil. In the second position of the magnet in Figure 22-G2, there was a "cancellation effect." The copper coil had only a 4-inch interior diameter and the cylindrical 14 lb. magnet had a 4-inch outside diameter. By placing the magnet *above* the coil (as in Figure 22-G2), the magnet's magnetic field would sweep across both sides of the copper coil in the same direction as the magnet itself rotated. (See Figure 22-G3.)

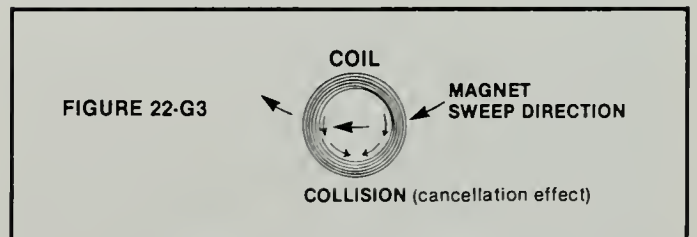

Consequently, some of the gyroscopic particles comprising the magnetic field of the rotating magnet would collide with some of the gyroscopic particles comprising the atoms of the coil at a right angle and generally

cause a "cancellation effect" of the repetitive, mechanical motions of the gyroscopic particles within the magnetic field in conjunction with the gyroscopic particles within the copper coil. This "cancellation effect" would vary with the speed of the rotating magnet.

²²
H. To you, the reader, I cannot overemphasize the fact that even the slightest alteration in the configuration of a particular system's design can effect a noticeable change in the observed results. You cannot take anything for granted!

"... even the slightest alteration in the configuration of a particular system's design can effect a noticeable change in the observed results."

²²
I. I will now describe a factual observation which should "open your mind" even further. I will refer to the commutator design already discussed and depicted above in Figures 22-C1 and 22-C2.

The above-described commutator was affixed to the shaft of a rotating, 100 lb., solid magnet (6-inch diameter and 12-inch length). [The 400 lb. magnet depicted in Figure 15-C1 on page 21 was part of my largest prototype.] The 100 lb. magnet was placed in the center of a very large coil composed of 4,200 lbs. of copper atoms (5-gauge copper coil). In addition, 300 lbs. of copper atoms (24-gauge copper coil) was wrapped around the larger, 4,200 lb. copper coil. The purpose of this configuration was to prove that most of the gyroscopic particles comprising the magnetic field emanating from the aligned atoms of the permanent, 100 lb. magnet would avoid collision with the gyroscopic particles comprising the atoms within the conducting coils. (See Figure 22-1 which is conceptually related to Figure 22-E above.)

In addition, because of the spatial placement of the coil and magnet, most of the gyroscopic particles comprising the magnetic field generated by the conductor coil would also avoid collision with the gyroscopic particles remaining within the atoms comprising the 100 lb. magnet. However, the gyroscopic particles comprising the magnetic fields of both the 100 lb. rotating magnet and the 4,200 lb. coil *would* react with one another as desired and designed by me.

²²
J. The results of a test utilizing the configuration of Figure 22-1 are described as follows:

Two (2) 40-watt fluorescent bulbs were connected in series as a resistance load to 300 lbs. (atoms) of a 24-gauge copper coil. A battery voltage (consisting of 66 volts of "hydraulic pressure" equaling 31 milliamps or 2.04 watts) was then input into the motor coil consisting of 4,200 lbs. (atoms) of 5-gauge copper coil. When the 100 lb. magnet rotated at 48 RPM, the two bulbs were emitting useful light, but were not continuously lit since they flickered at a rate consistent with each "break" in the current.

Now to state the *shocking fact* to those only skilled in the old teachings:

If the resistance load of the two (2) 40-watt fluorescent bulbs connected in series was *disconnected* (open circuit) from the generator coil consisting of 300 lbs. of atoms — and this was the *only* deliberate change made — then the 100 lb. rotating magnet would **reduce** its rotational rate within two minutes to 36 RPM. At the same time, average "catalytic" current input from the battery **increased** to 2.57 watts (equivalent to 39 milliamps X 66 volts input into the 4,200 lbs. (atoms) of 5-gauge, motor-coil conductor).

In essence, you will note that by *reducing* the load on the generator coil of 300 lbs. (of copper atoms), then the motor coil of 4,200 lbs. (of copper atoms) drew **more** power and resulted in the 100 lb. magnet *reducing* its rotational rate.

FIGURE 22I

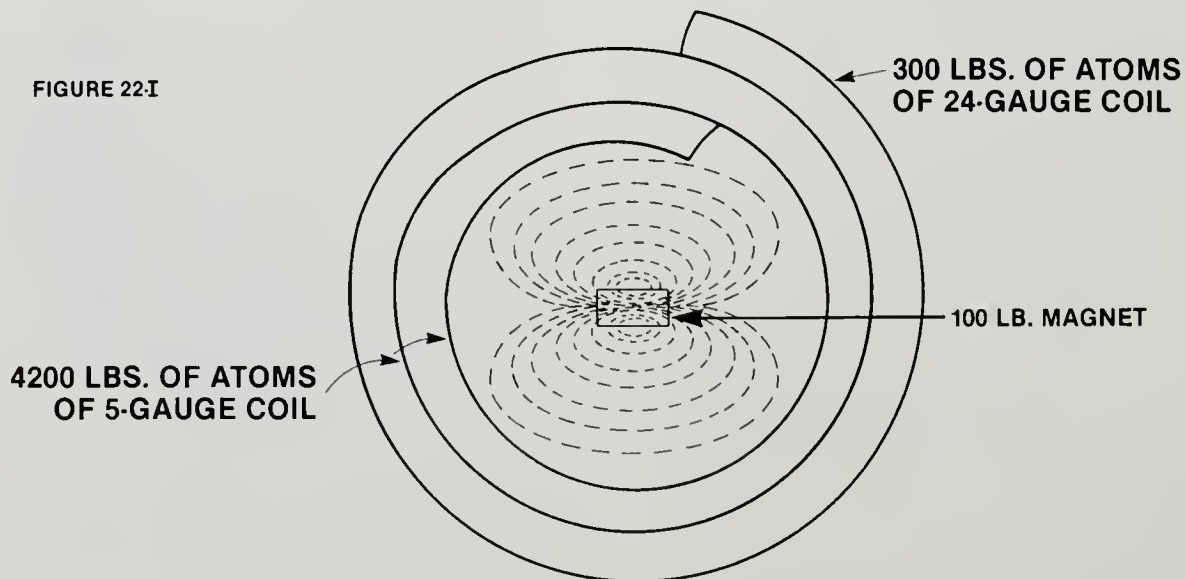

In effect, *the RPM of the rotating magnet decreased by 25% and the power demand increased by 25% when the load was removed from the generator!*

QUESTION: How can this result occur?

ANSWER: Simple, if you have Mastered my teachings. [It should be noted that I theoretically predicted such results in my original Patent Application long before I constructed the above-described prototypes.] I stated in my original Patent Application: as they aligned and unaligned, the atoms (within the generator coil of my prototype) could indeed have a “beneficial effect” upon the atoms of the motor coil in terms of the desired results. This “beneficial effect” would occur due to an “action/reaction effect” and vice versa.

Such an “action/reaction effect” is what occurred in the above-described test results. The *proper timing* of this “action/reaction effect” is essential to obtain the desired results.

EXPLANATION: When the load of the two (2) fluorescent light bulbs was connected into the circuit of the 300 lbs. (atoms) of the generator coil, then the atoms of the conductor coil would align and unalign properly. However, when the circuit was broken by removing the load (light bulbs) and leaving the circuit open, the atoms of the conductor coil could not properly align and unalign.

The proper timing relative to the segmented commutator (described in Figure 22-C1 and 22-C2) is very critical. For example: If the segmented commutator was simply flipped over 180° — enabling the coil-connected brushes to first make physical contact with the SHORTOUT SEGMENT, *then* the BLANK SEGMENT, *then* the FIRING SEGMENT (see Figure 22-J1) — the results would be that the light output of the two (2) fluorescent bulbs would be greatly reduced.

FIGURE 22-J1

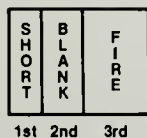

Such a reduced light output should be clear proof that *nothing* in this system I have described should be taken for granted! Why the resultant difference in light output? It should be obvious. In Figure 22-J1, the “timing sequence” first SHORTS OUT the motor coil via the SHORTOUT SEGMENT (creating a “current-break effect”), followed by a BLANK SEGMENT (nothing happens), and *then* the unit “fires” via the FIRING SEGMENT to align the atoms in the motor coil.

FIGURE 22-J2

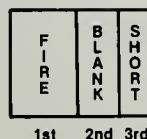

In the earlier test described above (in Section 22-C and pictured again in Figure 22-J2), the atoms of the motor coil are “fired” via the FIRING SEGMENT (releasing energy), followed by the BLANK SEGMENT (allowing the atoms to unalign [via the collapsing magnetic field] in the opposite direction to the energy of an expanding magnetic field), followed by the SHORTOUT SEGMENT (permitting the energy in the system to attempt to maintain atom alignment until the next FIRING SEGMENT). This sequence permits the energy of the system to apply a sustained force to keep the magnet rotating.

One should clearly see that there is an extreme difference in the energy-output-effects generated by different mechanical configurations. I must again stress the importance of the “timing” factor!

Actually, the reader should recognize that there are many different ways to design a system to replace the commutator circuitry described above. With additional research, one could select magnetic, electronic, or light-sensitive circuitry — to mention only a few.

“One should clearly see that there is an extreme difference in the energy-output-effects generated by different mechanical configurations.”

22

K. Let us now examine the effects of a similarly-designed, segmented commutator placed upon the shaft of a 14 lb. magnet adjacent to approximately 140 lbs. of 30-gauge (copper) conductor coil. (See Figure 22-K1.) [I must stress that my system is *not* limited to the use of copper as the conducting medium! There are other materials which — under certain circumstances — would permit more efficient atom alignment, *e.g.*, super-cooled niobium tin. Atom unalignment (as it occurs in copper) will also have to occur within the system.]

FIGURE 22-K1

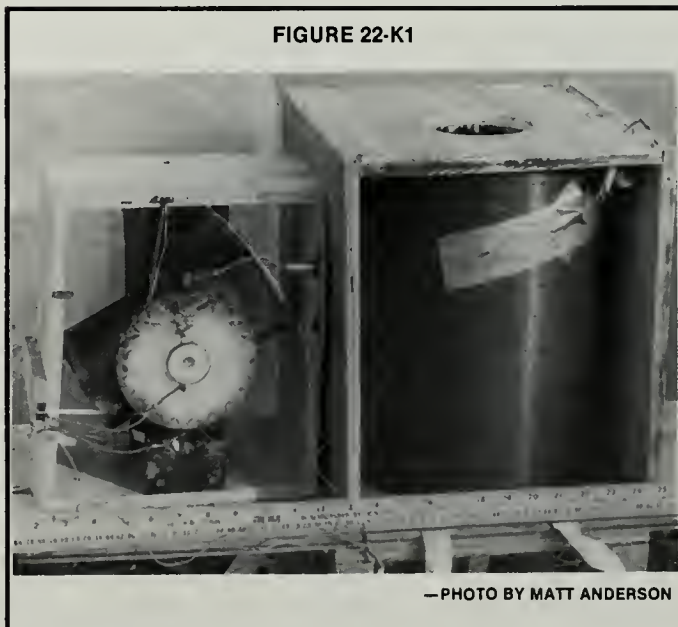

—PHOTO BY MATT ANDERSON

In prototype 22-K1, the FIRING SEGMENT on the commutator switch is 3/8" wide, the SHORTOUT SEGMENT is 1/8" wide, and the GAP between the FIRING and SHORTOUT SEGMENTS is 1/16" wide. In the configuration of this commutator, the position of the BLANK SEGMENT is combined with that of the SHORTOUT SEGMENT. This is accomplished by simply placing Scotch tape over the SHORTOUT SEGMENT. (See Figure 22-K2.)

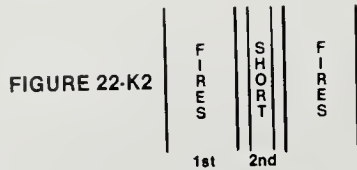

In Figure 22-K2, each SHORTOUT SEGMENT is covered with a thin layer of regular Scotch "magic" tape. As the commutator revolves, such a tape covering has the following effect: first the coil brushes connect with the FIRING SEGMENT and atoms within the motor coil align to produce energy; then the coil brushes pass over the SHORTOUT SEGMENT covered with tape which causes the atoms to unalign and produce energy in the same direction (per the discussion in Section 22-D). This energy traveling in the same direction causes a small spark to flash across the GAP between the FIRING SEGMENT and the SHORTOUT SEGMENT. In addition, there is a 76-watt, 8-foot, fluorescent bulb and three (3), 1/4-watt fluorescent bulbs connected in

"The most efficient system design is one in which the smallest amount of external current input will cause the greatest amount of atoms alignment and unalignment within the system."

series, but hooked parallel to the motor coil which in turn is connected to the rotating commutator. There are a total of twenty-eight (28) sequences consisting of FIRING SEGMENT-GAP-SHORTOUT SEGMENT-GAP-FIRING SEGMENT per rotation of the commutator.

Utilizing 960 volts (hydraulic pressure) input (from transistor batteries) into 140 lbs. (atoms) of 30-gauge, copper-coil conductor with 50,000 ohms of resistance, one has *only* 1.6 milliamps or 1.5 watts going into the system. As a result, the 14 lb., cylindrical magnet mechanically rotates at 105 RPM and all four fluorescent bulbs emit useful light, but not to full brightness due to a steady flickering. [Such lights flicker during each sequence of the revolving commutator. If the commutator were to turn faster, the flickering would become less and less noticeable and the brilliance of the lights would increase. With a sufficient rotational rate on the part of the commutator, the lights would achieve full brilliance and would seem to emit light at a steady rate since the flickering rate would occur faster than the human eye could detect.]

QUESTION: Can you predict what would occur if the coil in Figure 22-K1 was subjected to a cryogenic temperature?

ANSWER: The 50,000 ohm resistance in the coil would greatly decrease and the same voltage (hydraulic pressure) employed above would cause a greater number of atoms to align in the 30-gauge coil. This would result in an increased energy release (via a magnetic field created by gyroscopic particles). Atom unalignment will have to occur in this system as it does in copper at normal room temperature.

²²
L. The most efficient system design is one in which the smallest amount of external current input will cause the greatest amount of atom alignment and unalignment within the system. [This approach is contrary to and more efficient (over 100% production efficiency) than all electrical systems designed before this time!] As necessary, one can then have the means to unalign the atoms and also reduce the FIRING time.

EXAMPLE: Even at room temperature, the power output of a 30-gauge motor coil is *noticeably greater* than the external power input from a battery source. On an oscilloscope such power appears as described in Figure 22-L1:

FIGURE 22-L1

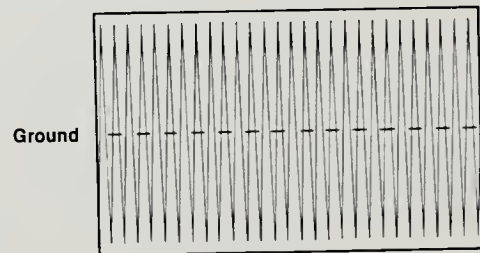

Scope leads connected to a 1 Ohm resistor.
Current = 2 Amp. per centimeter X 4 or
8 Amps. and Sweep Time in milliseconds

FIRES = 28 times per revolution
BREAK = 28 times per revolution
SHORT = 28 times per revolution

²²
M. Imagine a "friction-free" commutator (designed according to Figure 22-C above) which has a 5-foot diameter with FIRING, GAP, and SHORTOUT SEGMENTS built to the same dimensions as those in Figure 22-M1:

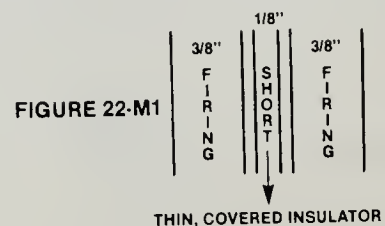

With such a commutator configuration, the FIRING, GAP, SHORTOUT sequence would occur over 360 times per revolution. Under such conditions, atom alignment/unalignment of the conductor occurs at a faster and faster rate, thereby producing greater and greater energy for the given “catalytic” energy input from an external source. Combine such action with the lower resistance within 140 lbs. (atoms) of a 30-gauge coil as discussed in Section L, and the results should be obvious: *the energy output will increase!* As stated earlier, there are many physical variations that become “obvious” once my teachings are *Mastered* and not *Memorized*.

EXAMPLE OF ANOTHER DESIGN: The commutators described above could simply consist of a FIRING SEGMENT and a GAP but not a SHORTOUT SEGMENT. However, such an arrangement will create sparking (wasted energy) if it is not properly designed. Such a proper design could consist of a bulb or resistance load placed across or parallel to the motor coil (connected to the commutator) that has a greater resistance than the motor coil itself. This would cause the external-power, “catalytic” input voltage (via the hydraulic effect) to push the current into the motor coil, but not push current noticeably through the bulb or resistance load. The electromotive force produced by the gyroscopic particles of the atoms within the conductor coil (as such atoms unalign to collapse the magnetic field) — which occurs as the coil-connected brush passes over the GAP — would then travel through the bulb or resistance load because such resistance is less than that required to ionize the air at the GAP. [It should also be understood that the mechanically-designed commutator can be replaced by other switch technologies which are more efficient.]

23. I shall now discuss the FIRING or “timing” sequences in conjunction with the battery design, and the results that will be observed from such sequences. [Review Sections I6-HI and 16-H2.]

Since the “action/reaction effect” described in Section 22-J occurs too quickly, the standard amp and volt meters will not be able to monitor the results quickly enough for proper observation. Therefore, it is necessary to use an oscilloscope that can be calibrated to an extremely fast “sweep-time” measured in millionths of a second.

23 **A.** The facts obtained by a thorough study of my energy machine prove that the most efficient battery design is one which functions *both* as a capacitor as well as a battery.

When current is released from a conventional capacitor, the voltage (hydraulic pressure) will quickly be reduced. I have already shown that in order to achieve the proper functioning of my energy machine, it is necessary to input a “catalytic” voltage (hydraulic pressure) which can be maintained as high as possible

(and preferably at a constant rate) to achieve maximum atom alignment within the conductor coil.

23 **B.** In my experience, I have observed that the dry cell battery already possesses certain mechanical characteristics which (accidentally) demonstrate several of the requirements necessary to have a capacitor as well as a battery. Such characteristics are even noticeable when I utilized the segmented commutator design (described above) and obtained high spikes of current produced by the atoms within the motor-coil conductor. Such current traveled in the same direction as the “catalytic” input current from the battery. (See Figure 23-B as seen on an oscilloscope. This is not drawn to scale.)



In Figure 23-B, the “catalytic” input current from the battery is so low that when set on the “volts-percent” position, the oscilloscope shows *no* input current from the battery (—). However, the current produced from the conducting coil appears on the oscilloscope as high spikes (▲) of current which travels in the same direction as the small, “catalytic” input current, then the spikes (▲) will travel off the screen (if the input current — is shown).

23 **C.** Without careful consideration, you, the reader, could assume that the high spikes of current from the conducting coil would quickly destroy the dry cell battery. The facts that I have observed in my experiments prove that such is not the case. The following mechanical examination of a dry cell battery combined with what I teach will explain why such battery destruction does *not* occur.

Examine the following drawing of a dry cell battery in Figure 23-C:

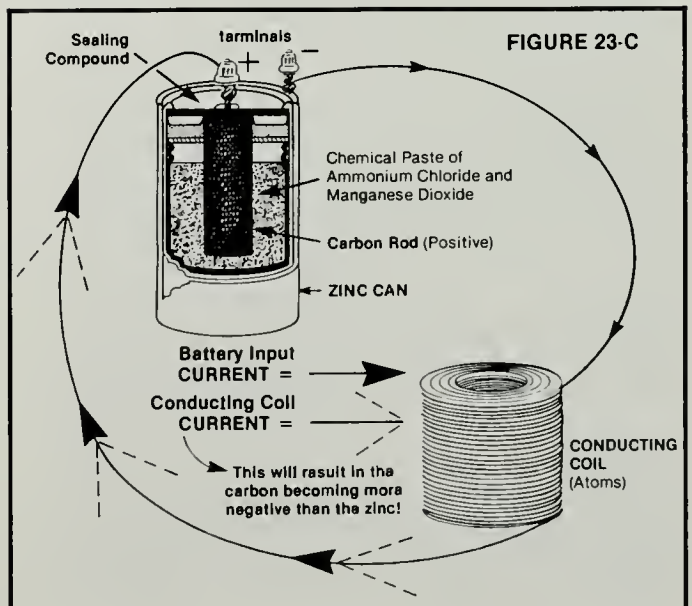

²³ D. Study carefully what “mechanically” occurs when the current (gyroscopic particles) initially flows from the zinc (atoms) into the conductor coil and returns to the carbon rod within the battery. *It should be obvious that energy has been removed from the zinc and has traveled to the carbon rod.* [This action then invokes Faraday’s Law of Electrolysis.] The metallic zinc delivers zinc ions to the electrolyte; if this process continues, the zinc would deteriorate until the cell would become useless.

²³ E. However, as the electrical process continues, study what “mechanically” occurs when current (gyroscopic particles) is released from the atoms of the conducting coil and flows into the carbon rod. *One should easily see that there is an extreme “mechanical” distinction (from that which occurs via Faraday’s Law of Electrolysis), because the zinc releases **no** energy and the carbon rod has **actually gained energy** (gyroscopic particles).*

²³ F. **QUESTION:** Why the difference in results obtained in Section 23-D compared to those of Section 23-E?

ANSWER: In Section 23-D, the zinc atoms contained an *excess* of gyroscopic particles which would readily flow to the carbon rod. However, in Section 23-E, the “mechanical” conditions have altered and the carbon rod now receives an *excess* of gyroscopic particles which mechanically cause the carbon to become more negative than the zinc. As this process occurs, a very sensitively-calibrated oscilloscope will depict the zinc as “positive” and the carbon rod as

Actually, too much output energy (gyroscopic particles) can destroy the desired results. Consequently, the amount of material (atoms) within the battery is directly proportional to the quantity of energy it can accommodate. [Other materials can be used for better results.]

²³ G. As depicted on an oscilloscope calibrated in millionths of a second, the voltage of a battery pack connected in series will show the following: [Note: A variety of voltages can be used. In my smallest prototype, I have used between 300 and 950 volts.]

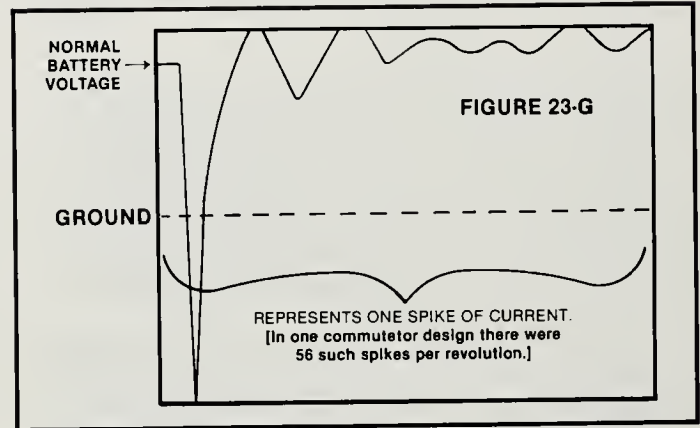

When current (gyroscopic particles) “shoots” from the conducting coil (atoms) into the carbon rod, the battery voltage will “shoot” sharply negative and then increase to an amount past the normal battery voltage. This indicates a charging effect upon the zinc within the battery followed by the “action/reaction effect” of additional discharges and charging action within the battery pack.

“I have been discussing the utilization of the atoms within a battery and the utilization of the atoms within a conducting coil on a 100%, conversion-efficient process in accordance with $E = MC^2$.”

“negative.” With such polarization, the “mechanical action” (described in Section 23-D) will attempt to invoke Faraday’s Law of Electrolysis and reverse this new process. At this point, the gyroscopic particles will flow from the carbon rod (acting as a capacitor) into the zinc which causes zinc ions to be removed from the electrolyte and return to the zinc itself.

This effect is probably most efficient when the current continues to reverse back and forth rapidly. Under such conditions, the zinc ions (which are initially delivered to the electrolyte) would not have a sufficient opportunity to solidly bind themselves with the electrolyte and would therefore be more easily “torn loose” to return to the zinc. Such action results in the voltage (hydraulic pressure) of the zinc rising higher than its initial voltage. My prototypes and dry cell batteries have demonstrated these described results although such results were not obtained at the highest efficiency of operation. [I encourage the reader to study, “Master,” and improve upon my results!]

24. In essence, *I have been discussing the utilization of the atoms within a battery and the utilization of the atoms within a conduction coil on a 100%, conversion-efficient process in accordance with $E = MC^2$.* The same is true with the use of a permanent magnet.

QUESTION: Have you “mastered” what I have taught you? [I must continue to ask you this question to ensure that you are simply not “memorizing” or “blindly accepting” what I am presenting in this Book.] What I have discovered is basically “simple.” But remember, it is “simple” *after-the-fact* of its presentation!

The perfection of production units for my Pioneering Invention must advance at a rapid pace with the support of every caring scientist, business individual, statesman, and human being upon this Earth. This energy machine will have a most beneficial effect upon all of us. The economic impact of this revolutionary invention upon the Earth will be discussed in Chapter 23.

Chapter 10

QUANTUM MECHANICS

"We hope that the present fluctuations of thinking are only indication of an upheaval of old beliefs which in the end will lead to something better than the mess of formulas which today surrounds our subject."

— Erwin Schrodinger

25. Up to this point, I have been discussing the mechanical utilization of the basic building entity of all matter: the "gyroscopic-action-entity." I will now conceptually relate the behavior of this "gyroscopic-action-entity" to QUANTUM MECHANICS.

[NOTE: I will now be discussing other important concepts concerning the nature of the gyroscopic particle. I must add that there are those who may feel that I should have published these other concepts in a separate book rather than combine their exposition with a presentation describing the nature of my energy machine. I disagree with anyone who may feel this way. The universal nature of the gyroscopic particles (more generally referred to as "gyroscopic-action-entities") which I have discovered is of *far greater significance* than one, simple application of their utilization, *i.e.*, my energy machine. By combining these two intellectual areas, I wish to stimulate the mind of the reader to think *beyond* the limitations of thought imposed by the study of one technical application. I would prefer that the reader give more careful consideration to understanding a universal principle: the principle inherent in the nature and action of the gyroscopic particle!]

25

A. I will quote several passages from a well-written book entitled *The Nature of Physics* by Peter J. Brancazio of Brooklyn College, City University of New York [published by MacMillan Publishing Company, Inc., New York, 1975]. From page 585:

WAVE-PARTICLE DUALITY

"The discovery that material particles exhibit wave characteristics adds a new dimension to the problem of wave-particle duality. The classical descriptions of light as a wave and matter as composed of solid particles no longer seem valid — for both matter and light have been found to display wave and particle characteristics. How can we provide a coherent explanation for these extremely puzzling discoveries? One way to resolve the problem of wave-particle duality is to assume that one or the other is more fundamental. There are two possible alternatives:

"(1) Light and matter are ultimately composed of particles. Their wave properties derive from the group behavior of a large number of interacting particles. [This approach, it will be recalled, was unsuccessfully adopted by Einstein in an attempt to explain the behavior of light.]

"(2) Light and matter are ultimately composed of waves. The particle properties are then derivative. One could hypothesize that 'particles' are really concentrations of waves or perhaps stable condensations in an underlying fluid or field.

"Unfortunately, neither of these alternative hypotheses has been developed with any great success. Most modern-day physicists generally believe that neither particles nor waves are more fundamental, but rather that they are two manifestations of some as-yet-unidentified (and possibly unidentifiable) entity.

"If the beginning student has trouble understanding how an entity can possess both wave and particle attributes at the same time, he or she may be comforted to learn that most experienced physicists are just as disturbed by this problem."

Quoting from *The Nature of Physics*, page 604:

"Einstein firmly believed that underlying the quantum theory — perhaps on a subquantum level — there had to be fully deterministic laws. In a letter to Max Born written in 1926, Einstein summarized his position:

'Quantum mechanics is very impressive. But an inner voice tells me that it is not the real thing. The theory has much to offer ... but I am convinced that God does not throw dice.'

"At the present time, nearly fifty years after the birth of quantum mechanics, the argument has not been settled. There is no evidence whatsoever that a deterministic subquantum level exists. Nor is there any convincing evidence to support the orthodox

interpretation. For example, no experiments have ever been performed on a single atom or electron to test the orthodox contention that the wave function describes the properties of a single particle rather than a group of particles. Although the orthodox interpretation is generally accepted, there remain a few who, like Einstein, believe that the mathematical formalism of quantum mechanics is not the final answer. This attitude has been most eloquently described by Erwin Schrodinger:

‘Many maintain that no objective picture of reality is possible. However, the optimists among us (of whom I consider myself one) look upon this view as a philosophical extravagance born of despair. We hope that the present fluctuations of thinking are only indications of an upheaval of old beliefs which in the end will lead to something better than the mess of formulas which today surrounds our subject.’

²⁵

B. My work pays tribute to those thinking individuals such as Einstein, Schrodinger, Faraday, Maxwell, Newton, and others. The sensitive and inquisitive mind will see that my work more accurately brings together the work of these impressive contributors for the advancement of the human species. The effect of such intellectual “bringing together” is to generate a new “oneness” which is more impressive and beneficial than the work of any single, great innovator alone.

Let me begin by pointing out that the mathematical consequences of the Dirac equation stipulates that the energy terms applied to a fourth quantum number having two values, $(+ \frac{1}{2})$ and $(- \frac{1}{2})$, are identical to the *spin-quantum-number* M_s which assigns to the electron an intrinsic spin and states that magnetism is a result of electron spin within the material. On the other hand, it has still been taught that a magnetic field contains no kinetic energy — only potential energy — and that the “lines of force” surrounding a magnet are imaginary. [This erroneous concept has been taught in spite of the brilliant insights of Faraday and Maxwell!]

tum mechanics to the mechanical essence of all matter consisting of the gyroscopic-action-entity which I present in this Book.

A gyroscopic action is the “mechanical” essence of a “spin.” I will now present many (seemingly unrelated) scientific facts which I examined years ago for the purpose of testing the truth of my Hypothesis and ascertaining if my Hypothesis could explain other scientific observations for which there was no “mechanical” understanding.

²⁵

D. If we do not have a unified, “mechanical” understanding of the essence of all matter, then what we physically “see” as an outsider to matter can be very deceiving.

EXAMPLE:

(See Figure 25-D1.)

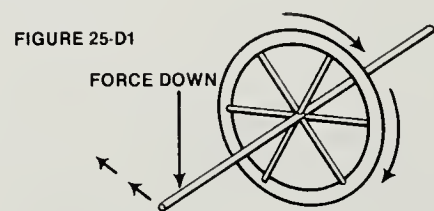

Have an uneducated individual view a gyroscope spinning in a clockwise direction as it faces the individual. Have that individual push down on the axis of the gyroscope. Because the individual observes that the gyroscope pivots to the left (with respect to the individual), the individual may arbitrarily call such pivotal motion “negative.”

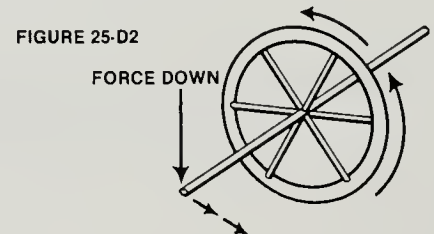

While the same individual closes his eyes, reverse the spin of the gyroscope in such a way that it now spins (see Figure 25-D2) in a counter-clockwise direc-

“ ... the essence of Magnetism, Electricity, Gravity, Inertia, Planetary Motion, Thermodynamics, and a New Source of Energy and Matter are all mechanically explained by the nature of a ‘gyroscopic, action-type particle.’ ”

²⁵

C. You will discover in this Book that the essence of Magnetism, Electricity, Gravity, Inertia, Planetary Motion, Thermodynamics, and a New Source of Energy and Matter are *all mechanically explained* by the nature of a “gyroscopic-action-type-particle.” It was long after I had developed my concepts that I discovered my “mechanical” explanation correlated precisely with Dirac’s concept of mathematical spin. The reader should find it easy to advance from quan-

tion as it faces the same individual. Have the individual open his eyes and push down on the axis of the “same” gyroscope. Because the individual then observes that the gyroscope pivots to the right, the individual may arbitrarily call such pivotal motion “positive.” Such subjective descriptions would appear to indicate that there are two different gyroscopes. However, you and I know that this is not the case. Actually, what the individual believed to be two dif-

ferent gyroscopes is, in fact, one and the same: a single gyroscope simply having its mass spinning in the opposite direction relative to the outside observer.

25

E. I will now quote to you a statement I made on the occasion of my "humbling" realization of this simple fact described in Section 25-D in conjunction with the basic entity of all matter. I clearly recall the occasion in 1968 while flying on a commercial airline at 30,000 feet and returning home from a trip to Washington, D.C. which concerned another patent application:

"I SIT IN AWE UPON THE REALIZATION OF THIS INGENIOUS MECHANISM THAT IS SO SIMPLE THAT IT BEFUDDLES THE MIND. MAGNETIC FIELDS AND ELECTRICAL FIELDS ARE INDEED EQUAL. THEY ARE ONE AND THE SAME."

Extrapolating upon my "humble" thought, I concluded: consider the possibility that if you could exert enough force to flip over this basic gyroscopic-action-particle of matter 180°, then to an outside observer it would appear to be an opposite, electric

"All matter is composed of one type of gyroscopic-action-particle."

charge. Since this is true, then the basic mechanism of nature is even more ingenious than I suspected because: all matter is composed of one type of gyroscopic-action-particle. Moreover, by mechanically rotating (in varying degree directions) the gyroscopic-action-particles, such particles are capable of exerting a "force influence" upon one another. Such a "force influence" causes the gyroscopic-action-particle to gyrate (relative to one another) and subsequently, ***such infinitely-possible-degree-gyrations form infinite types of matter.***

Such a perspective is consistent with all Matter in the Universe being composed of the same entity having an attraction of one towards another. Mathematically, this explains the consistency of the Laws of Magnetism, Electrical Charge, and Gravity.

Chapter 11

LIGHT

"Planck's discovery of the quantum in 1900 drove a crack in the armor that still covers the deep and secret principles of existence. In the exploitation of that opening we are at the beginning, not the end. Someday we'll understand the whole thing as one single marvelous vision that will seem so overwhelmingly simple and beautiful that we will say to each other — Oh, how could we have been so stupid for so long? How could it have been otherwise!"

— John Archibald Wheeler

²⁵ **F.** I will now demonstrate that the "gyroscopic-action-particle" which comprises all matter will mechanically explain other scientific facts which have not been mechanically explained before this time.

Consider that the existence of the "gyroscopic-action-particle" also explains the duality of the wave and particle theories of light. Light is electromagnetic in nature and consists of "negative" and "positive" (see discussion of "negative" and "positive" in Section 25-D) gyroscopic particles traveling in the same direction and having opposite spins. When the axis of the gyroscopic particles are affected as they mechanically collide with different materials at varying angles, the gyroscopic particles will therefore behave as particles or a wave. If one "hits" the axis of a gyroscope "head on," it will not pivot.

The following information corroborates the prior information I have presented in this Book. I urge the reader to Master the Mechanical Essence of this material. The material demonstrates that one must pay strict attention to the sub-atomic composition (gyro-

"Light is electromagnetic in nature and consists of 'negative' and 'positive' gyroscopic particles traveling in the same direction and having opposite spins."

scopic spin) of all matter which is pertinent to those varying technical designs utilizing Einstein's equation of $E = MC^2$ on a 100% conversion-efficient basis.

²⁵ **G.** John Dalton (English chemist and physicist, 1766-1844) proved that when various elements were observed through a microscope, such elements appeared in different crystalline shapes. Crystals of gold always looked alike, crystals of copper always looked alike, but crystals of gold and copper *never* looked like one another.

It has also been proven that a sharp "hit" will easily break crystals at certain mathematical points and will not easily break the crystals at other points.

Considering the two preceding paragraphs, it is obvious that the energy comprising different crystals representing different elements has an attraction force throughout the crystal. This attraction force is greatest along a particular plane: *the GYROSCOPIC PLANE!*

²⁵ **H.** Observe the effects of light polarization by certain crystals:

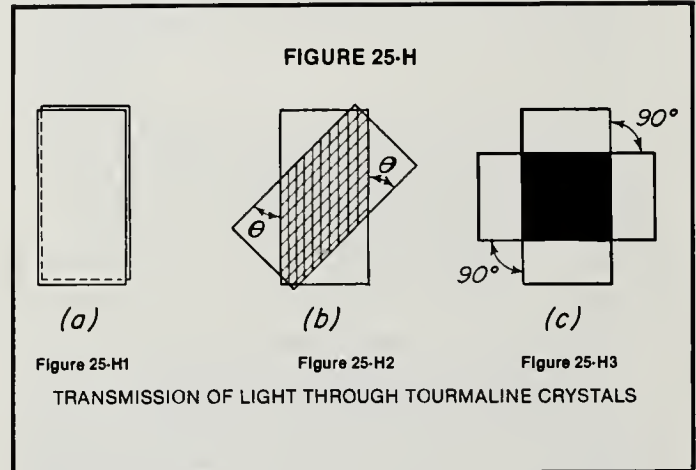

Figure 25-H1 Light is transmitted through crystal slabs having their crystalline axes oriented parallel with respect to one another.

Figure 25-H2 Less light is transmitted when one of the crystal slabs is rotated to a 45° angle with respect to the other slab.

Figure 25-H3 No light is transmitted when one of the crystal slabs is oriented at a 90° angle with respect to the other slab.

As the angular degree of the crystal (composed of electromagnetic energy in the form of gyroscopic particles) varies, the amount of light (electromagnetic energy in the form of gyroscopic particles) also varies. Such a variation indicates that the crystal is held together with greater electromagnetic force along certain planes: *the GYROSCOPIC PLANE!*

²⁵ **I.** Sir David Brewster (Scottish physicist, 1781-1868) was the first to note that when light is incident at the polarizing angle, then the reflected and refracted rays are exactly 90° apart.

Notice that the 45° and 90° angles are significant in the application of force to light (electromagnetic energy). This effect matches the 45° angles of prisms and pyramids as well as the 90° angle important to a conductor system.

25
J. What does the picture below represent?

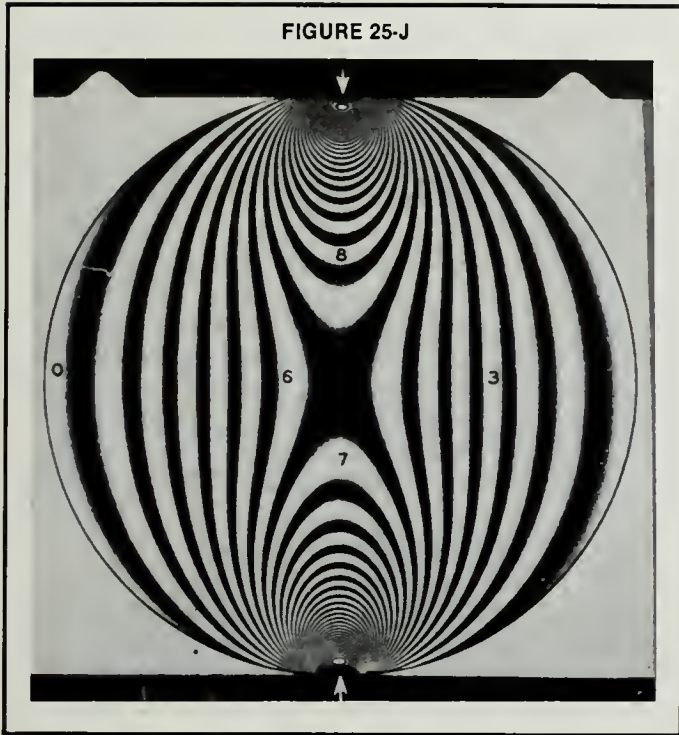

Does Figure 25-J appear similar to the forces generated by an electric or magnetic field? Actually, Figure 25-J represents a picture of a sheet of glass undergoing stress which causes the glass to doubly-refract. If there was no physical (mechanical) strain upon the glass plate, the plate would have *no* effect upon the light passing through it. One may then conclude that when placed under stress, the glass plate releases a glimpse of its “secret” concerning the plane of its electromagnetic composition.

25
K. Certain materials (liquid mixtures) have the property of rotating the plane of light polarization by an amount directly proportional to the length of the light path in the sample.

(1) Some materials cause a rotation that is clockwise when viewed towards the light source.

(2) Some materials cause a rotation that is counter-clockwise when viewed towards the light source.

(3) Observe that such rotations match my description of “negative” and “positive” charges. These negative and positive charges compose all matter and represent the same gyroscopic entity seeming to spin in opposite directions (when viewed from the perspective of an observer).

(4) Observe that such rotations indicate that materials are either a little more negative or positive in charge depending upon their electromagnetic composition. Unless such is the case, why else would differing liquid solutions have reverse effects upon light (electromagnetic energy)?

25
L. The first connection between magnetism and optics was discovered by Michael Faraday in 1845. Faraday discovered that the plane of light polarization is rotated when polarized light is allowed to pass through an isotropic medium located within a strong magnetic field if the light travels in a direction parallel to the direction of the magnetic field. This observation demonstrates the effect of gyroscopic spins comprising light interacting with the gyroscopic-spin-composition of matter and magnetic energy with respect to the plane of gyroscopic spins of *all* interactions.

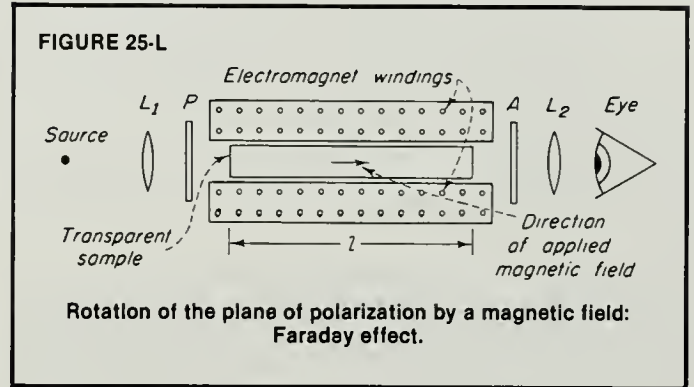

25
M. A related, magneto-optical effect to that of Faraday’s was discovered by John Kerr in 1875. Kerr found that an isotropic, optical medium placed between the plates of an electrical condenser became doubly refracting when the condenser is charged. This observation again demonstrates the presence of the gyroscopic spin or plane.

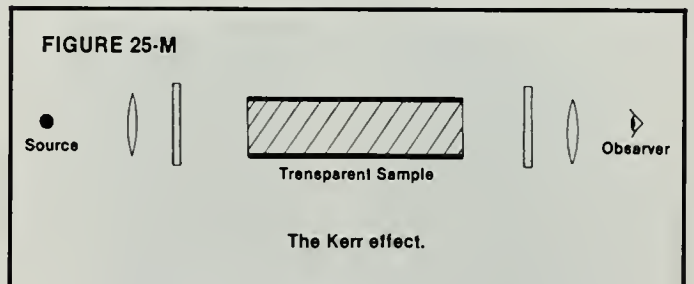

25
N. An effect similar to that of John Kerr’s was also discovered by A.A. Cotton and H. Mouton in 1907. They found that certain isotropic, optical media become doubly refracting when placed in a strong magnetic field. Such an observation again demonstrates the presence of the gyroscopic spin or plane.

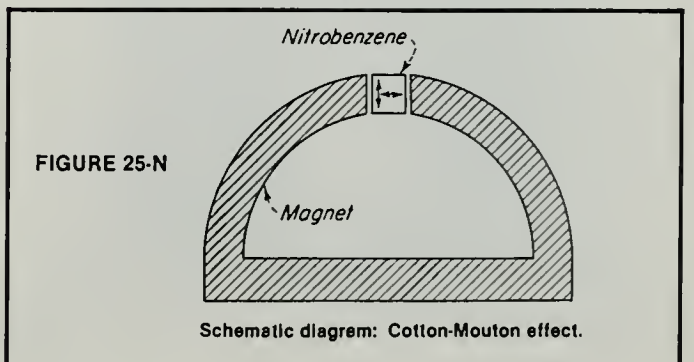

O. All of the above processes — which involve producing double refraction in a normally isotropic medium via the application of mechanical deforming forces, magnetic fields, and electrical fields — have a basic similarity: in each case, *physical (mechanical) strains* are produced within the medium which accordingly becomes anisotropic.

Consequently, there is a definite, scientific pattern which emerges in the above observations: **the gyroscopic composition of matter reacts to a proper force.**

(1) Observe that in all cases a force is applied which causes the electromagnetic composition of the material to react.

(2) Observe that in all cases the presence of electromagnetic energy is obvious.

(3) Therefore, in all cases the reactions were due to the material composition (electromagnetic energy) being affected by the mechanical action of such electromagnetic energy (consisting of gyroscopic particles). Such reactions demonstrate the “action/reaction effect” created by the gyroscopic spin or plane which constitutes the basic mechanical structure of all matter.

P. Such an “action/reaction effect” is observed in the following example:

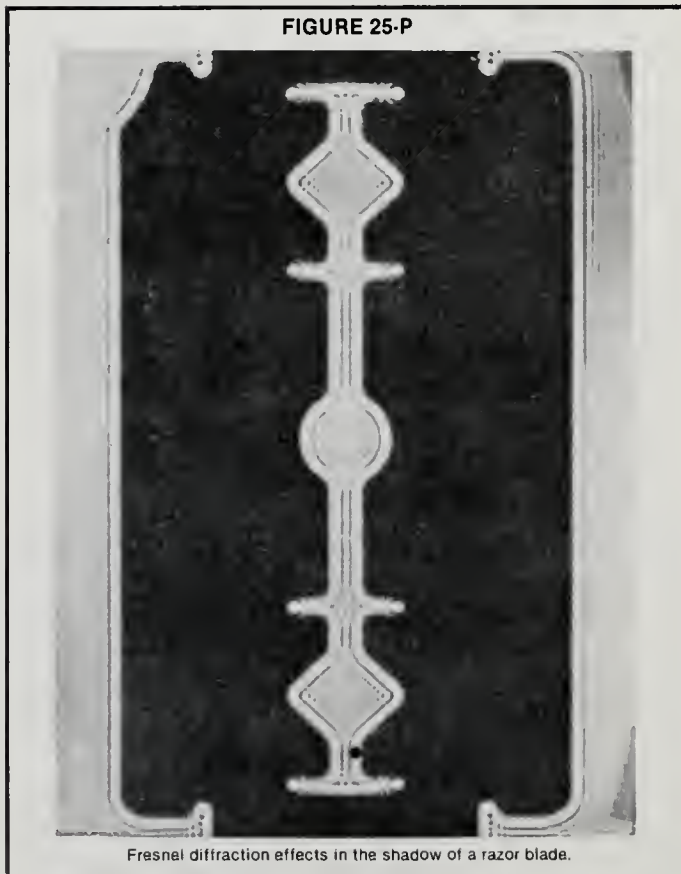

The photograph in Figure 25-P depicts the effects of

light (electromagnetic energy, *i.e.*, gyroscopic particles) “colliding” with a material (a razor blade also composed of electromagnetic energy, *i.e.*, gyroscopic particles) at an angle which graphically demonstrates the effect of the gyroscopic action and gyroscopic planes. Observe that the light and dark lines (which surround the outer periphery of the razor blade) form the conventional patterns of electric or magnetic “lines of force.”

One should recognize that the light and dark lines are explained by my description of “negative” and “positive” charges which represent opposite spins of the gyroscopic-action-type-particle. The observed patterns in Figure 25-P will occur when such gyroscopic particles travel in the *same direction* (as light) and have their axes acted upon by a force which causes them to move at right angles to the imposed force as well as to one another. [This explanation satisfies both the wave and particle theories of light!]

As described in Chapter Three, a magnetic field consists of “negative” and “positive” particles — [the same gyroscopic particle is described as being either “negative” or “positive” via the direction of its *spin* with respect to the frame of reference of the outside observer] — with opposite spins and traveling in opposite directions like cars on one-way streets. In addition, when a conductor wire is applied (as a mechanical force) at right angles to those “negative” and “positive” particles, both “versions” of the single, gyroscopic particle traveled down the conductor wire in the same direction.

It should now become apparent how light can be produced from an electric current which consists of gyroscopic particles traveling in the *same* direction with opposite spins.

When light strikes an object (as the razor blade in Figure 25-P) at the appropriate angle, the gyroscopic particles (having clockwise and counterclockwise spins comprising the light) travel in opposite directions or have some alteration of their original direction. This mechanical action creates the image of an electric or magnetic field via the observed “lines of force.” Such action should clearly demonstrate the gyroscopic effect of matter.

To summarize two important points:

(1) *A magnetic field mechanically consists of “negative” and “positive” gyroscopic particles having opposite spins and simultaneously traveling in **opposite** directions, e.g., the concentric “shells of force” surrounding a bar magnet. (Refer back to Chapter Three for a detailed analysis of this effect.)*

(2) *An electric current mechanically consists of “negative” and “positive” gyroscopic particles having opposite spins and traveling in the **same** direction down a conductor wire — as does light traveling in space through a medium.*

FIGURE 25-P

MAGNETIC FIELD AND ELECTRIC CURRENT

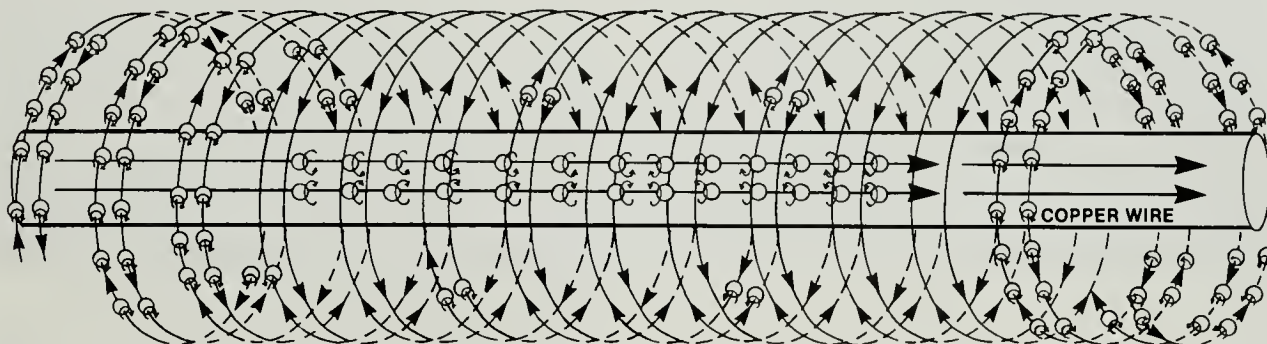

A **magnetic field** mechanically consists of "negative" and "positive" gyroscopic particles having opposite spins and simultaneously traveling in **opposite** directions, e.g., the concentric "shells of force" surrounding a bar magnet.

An **electric current** mechanically consists of "negative" and "positive" gyroscopic particles having opposite spins and traveling in the **same** direction down a conductor wire — as does light traveling in space through a medium.

from original sketch by Robert J. Matherne

25

Q. Further evidence of the gyroscopic effect of matter is demonstrated by the following:

(1) Every chemical element emits a characteristic spectral line when the atoms of the element are excited in a flame, furnace, or in an electric discharge. This again demonstrates the varying electromagnetic composition of different materials. [Since all matter is composed of the same gyroscopic particle, the electromagnetic composition of matter varies with the particular angle of incidence (plane of spin) for a given gyroscopic particle.]

These spectral line variations are similar to the light and dark lines that become visible when materials are placed under physical (mechanical) stress. Both of these effects are a result of the electromagnetic composition of all matter.

(2) If the material comprising a prism is altered, the spectrographic lines will also change in their distance between one another. This effect corroborates my explanation that different materials are different electromagnetically, *i.e.*, their gyroscopic planes vary. Consequently, the degree of deflection of penetration of different materials by light traveling at a 45° angle will vary continuously as will light deflection.

(3) Such action on the part of light is further evidenced by the Zeeman Effect. [Pieter Zeeman had searched for another magnetic effect upon light since he knew that Faraday had believed that another effect

should exist.] The Zeeman Effect represents the splitting of spectral lines into components of slightly different frequencies when the light source is placed in a strong magnetic field.

(4) In Sections 25-Q(2) and 25-Q(3) above, the described effects upon spectrographic lines are similar. Such lines are a characteristic of each element's gyroscopic (electromagnetic) composition. In (2) above, the spectrogram's lines vary when travel-

"All of the above observations demonstrate the importance of the gyroscopic-action composition of all matter and demonstrate that even slight changes in the electromagnetic composition of materials can produce a noticeable difference in observed results."

ing through different materials having different gyroscopic (electromagnetic) composition. In (3) above, the spectrogram's lines vary under the influence of an external, electromagnetic (gyroscopic) field.

All of the above observations demonstrate the importance of the gyroscopic-action composition of all matter and demonstrate that *even slight changes* (in materials via the gyroscopic angle of incidence) can produce a **noticeable difference** in observed results.

R. The following is additional evidence concerning the importance of the gyroscopic conception of matter:

(1) The observed, spectrum "band" of colors produced when white light is dispersed by a prism actually varies in hue on a continuous basis from the violet to the red end of the spectrum. Such a spectrum is *not* composed of seven distinct "bands."

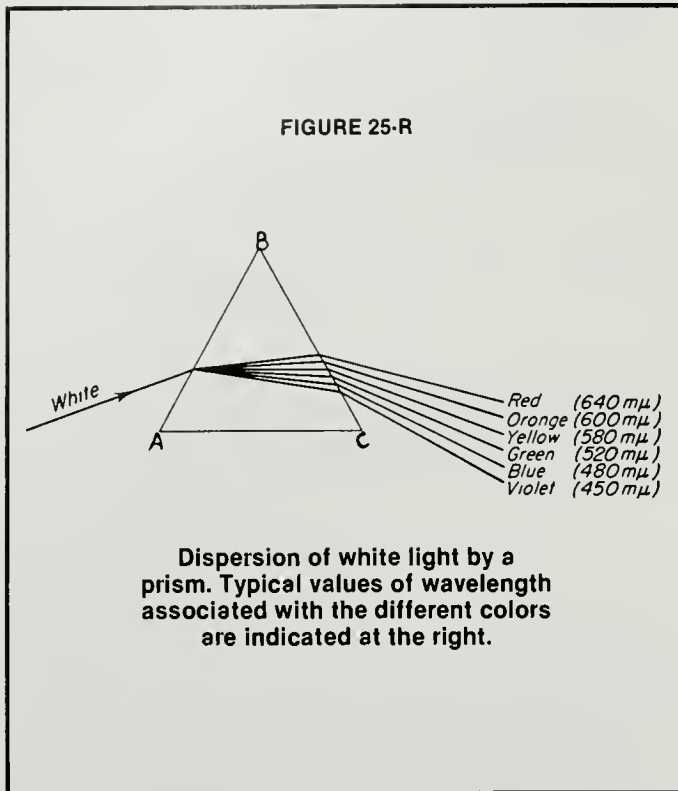

(2) If one applies my description of "negative" and "positive" particles with opposite spins (gyroscopic action) to Figure 25-R, then the observed spectral results will be precisely explained:

REASON: The gyroscopic particles comprising light have opposite spin directions. These gyroscopic particles either collide with other gyroscopic particles comprising the atoms of the prism or they have an influence-force placed upon them by the gyroscopic particles comprising the atoms of the prism. This "collision" or "influence-force" mechanically occurs as a result of a close encounter between the loosely-bound gyroscopic particles within the light causing such gyroscopic particles to move at right angles to the force exerted upon them by the more tightly-bound gyroscopic particles within the prism. However, because of their opposite spins, the gyroscopic particles comprising light will move in opposite directions to that force as they encounter the gyroscopic particles within the prism, *i.e.*, one gyroscopic particle within the light will move "right" (at some angle between 0° and 90°) and the other gyroscopic particle (having an opposite spin) within light will move "left" (at some angle between 0° and 90°).

Remember that light consists of gyroscopic particles moving in the *same direction*, but with a (possibly) equal number of such particles spinning in one direction and a (possibly) equal number of gyroscopic particles spinning in the other direction. All such gyroscopic particles are interspersed throughout the general flow direction of the light.

In figure 25-R, the spectral lines travel to the left and to the right of the point where light (electromagnetic energy) first physically enters into surface AB at a 45° angle.

If you imagine numerous surfaces parallel to surface AB and oriented throughout the prism (which is actually a three-dimensional pyramid), then you will recognize that the gyroscopic particles of light vary continuously in their angular degree of penetration (of a 45° angle) as they pass through the material.

The continuous variation in color hue is created by the continuous variation of "negative" or "positive" gyroscopic particles that exist in any one plane (surface) within the prism. [The electromagnetic function of the eye with respect to the brain is appropriate to how or what we visualize.]

(3) The fact that infrared and ultraviolet light are located at opposite ends of the spectrum operationally means that one color "band" has more "negative" charges and the other "band" has more "positive" charges. Consequently, the two color "bands" represent different types of *matter!*

"In reality, each gyroscopic particle consists of identical gyroscopic-action-entities which demonstrate both "negative" and "positive" characteristics depending upon the gyroscopic orientation of the spin with respect to the outside observer."

From the beginning of my research, I have endeavored to prove that all matter is composed of a varying amount of "negative" and "positive" gyroscopic particles. In reality, each gyroscopic particle consists of identical gyroscopic-action-entities which demonstrate both "negative" and "positive" characteristics depending upon the gyroscopic orientation of the spin with respect to the outside observer. Moreover, the arrangement of such gyroscopic-action-entities (via slight degree changes in their respective axes of rotation) can be infinite. Such infinity can generate infinite forms of matter.

(4) Gyroscopic action also provides an explanation for the nature of X-rays which originate by separating electrical terminals while placed in a partial vacuum. Such a separation causes different amounts of "negative" and "positive" gyroscopic particles to be released, thereby forming another type of *matter*.

FIGURE 25-S

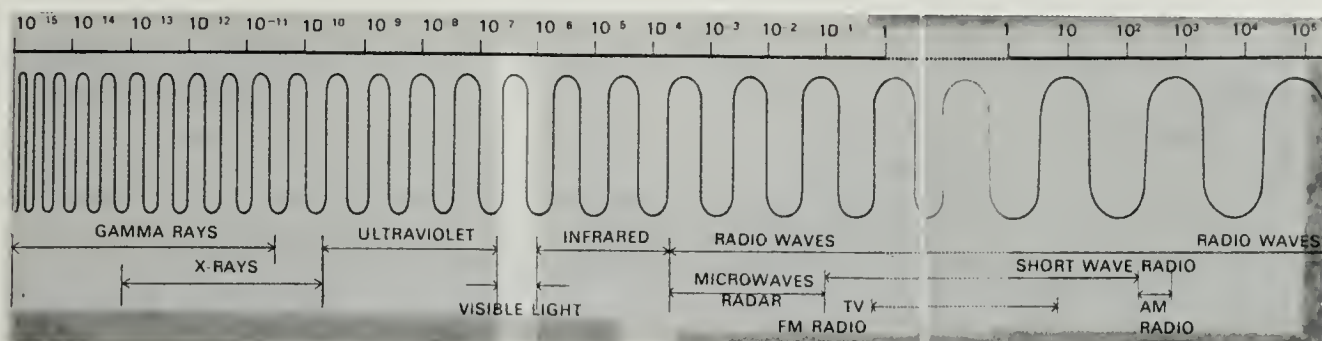

²⁵
S. You may now be beginning to understand how the “spin” orientation of gyroscopic particles provides an explanation for all rays emitted by different materials. Such gyroscopic action (“negative” or “positive”) is also verified by the fact that as certain rays are emitted from one type of material, that same material will undergo decay into another form of material. The new material is composed of a different quan-

“The wave motion of these rays are caused by a variation in the number of ‘negative’ or ‘positive’ gyroscopic particles composing a given ray as well as the angular degree by which such rays are emitted from their source.”

tity of “negative” and “positive” gyroscopic particles.

The opposite effect is also true: by bombarding uranium atoms with neutrons (which are agglutinations of gyroscopic particles) the uranium is transformed into the heavier element transuranium.

The differing forms of matter which are continuously observed in cyclotrons are forms generated by the interaction of “negative” and “positive” gyroscopic particles. There are infinite, possible forms that such matter can assume. Such infinite forms are caused by high-velocity particles reacting with “negative” and “positive” gyroscopic particles comprising (and traveling within) the tremendous electromagnetic fields generated by such units.

Based upon the electromagnetic field experiments of Michael Faraday, the electromagnetic theory of radiation was proposed by James Clerk Maxwell in 1865 and experimentally corroborated 20 years later in Germany by Heinrich Hertz.

It should be obvious from studying Figure 25-S that

all rays have something in common: such rays are *all* electromagnetic energy and they are therefore composed of gyroscopic-action-entities.

What causes such rays to differ? I have endeavored to prove that the wave motion of these rays are caused by a variation in the number of “negative” or “positive” gyroscopic particles composing a given ray as well as the angular degree by which such rays are emitted from their source.

²⁵
T. QUESTION: Have you Mastered what was taught in Section 25 above? If you have, then you must now realize the critical importance of understanding the *mechanical, gyroscopic-action-entity* comprising the atoms of all materials. Many such materials will be used in energy machines designed for 100% (conversion) efficient utilization of Einstein’s equation of $E = MC^2$. Such an understanding will also permit the creation of new materials with varying electromagnetic characteristics.

“The behavior of the gyroscopic particle can still be mechanically understood and operationally predicted in accordance with Newtonian Mechanics.”

By studying what I have written, you have glimpsed the Mechanical Essence of Quantum Mechanics: **the Gyroscopic-Action-Particle**. This “gyroscopic-action-particle” is the basic building block of **all** matter and is the mechanical essence of $E = MC^2$. The behavior of the gyroscopic particle can still be mechanically understood and operationally predicted in accordance with Newtonian Mechanics.

If you have Mastered what I have earnestly sought to teach you up to this point, then you should have no difficulty in understanding and Mastering the teachings which will follow.

Chapter 12

USEFUL “WORK, FORCE, AND POWER” EQUATIONS

26

A. The mathematical equations involving “Work, Force, and Power” are engineering equations which satisfy the *past* and present-day industries of the world. They are **not** appropriate to *future* industries. Such equations are *not* universal, scientific equations and they do not satisfy a rigorous scientific scrutiny. The equations which I will propose below *are* scientific equations and *do* satisfy scientific scrutiny. In addition, these equations will fulfill the *future* engineering need of industry and will conceptually mesh with an understanding of the gyrosopic-action-entity which is the basic building block of all matter and represents the mechanical essence of $E = MC^2$.

I will now define a “Force” in accordance with Newton’s Laws:

“A ‘Force’ is any action capable of causing a reaction from an entity *which is in or may enter* the influence of that ‘Force’!”

To an observer, “Force” may be perceived as “*Obvious*” or “*Unobvious*.” I mathematically distinguish between “Obvious” or “Unobvious” Force. One cannot have (Obvious or Unobvious) “Work, Force, or Power” occurring without energy participation and transference.

The consistent, semantic application of the terms Obvious or Unobvious to “Work, Force, or Power” will *accurately* stimulate the mind of the thinking individual which will further the progress of science and the improvement of the Human Race.

26

B. It is the essence of the scientific method that a scientific theory should stand or fall with respect to whether its predictions correspond with the Facts. With this in mind, I will now apply the *conventional* mathematical formulas for Work, Power, and Force to a factual observation:

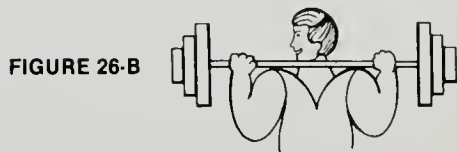

FIGURE 26-B

“A man has a 400-pound mass placed upon his shoulders. The gravitational force pushes down with 400 pounds upon the man. The man pushes up with 400 pounds of force on the mass. The man supports the 400-pound mass for 10 minutes and then pivots from

under the mass to permit it to fall. (Had the man continued to support the mass he would have become fatigued to the point of collapse and physical damage.)”

WORK = FORCE X DISTANCE (by conventional mathematics)

According to this simple formula, the man in the above example did no work.

POWER = WORK ÷ TIME (by conventional mathematics)

According to this simple formula, the man in the above example exerted no power.

FORCE = MASS X ACCELERATION (by conventional mathematics)

According to this simple formula, the man in the above example exerted no force.

[I should point out that from the perspective of Statics, there is FORCE exerted but there is no POWER or WORK.]

Because the force of the man and the force of gravity upon the mass are equal and opposite, then conventional mathematics would state that there is a net force of zero.

26

C. I will now examine the internal actions of the man in Figure 26-B to determine if the predictions obtained via conventional mathematics correspond with the Facts.

The Facts are as follows: During strenuous exercise or stress, the heart may pump eight times as much blood as in a period of relative relaxation, *i.e.*, as many as 12 gallons a minute. All of the following conditions drastically increased while the man held the mass: the heartbeat, blood flow, breathing, oxygen flow, the electromagnetic stimulation of the brain and body cells, and the fermentation process to produce energy occurring within the muscle cells.

Internally speaking, the man *did* produce Work and Power which resulted in the man producing a Force. Internally speaking, Potential Energy was converted to Kinetic Energy. It is important to note that the Potential Energy of the mass being supported by the man was a direct result of the internal, Kinetic Energy within the man. In essence, *the presently-accepted, mathematical equations concerning Work, Power, and Force do not correspond with the facts.*

26

D. To properly view the Facts from a scientific basis, the man in the above experiment *did* produce *Unobvious* Work, *Unobvious* Power, and *Unobvious* Force. Until he dropped the 400-pound mass, both the man and gravity exerted a force. Consequently, the net force could not be zero — only the net movement was zero.

26

E. By subjecting them to proper scientific scrutiny, the presently-accepted, mathematical formulas describing Work, Power, Force, Potential and Kinetic Energy are **not** scientifically accurate! I propose that more explicit and scientific mathematical formulas would be as follows:

$$\text{OBVIOUS WORK} = \text{FORCE} \times \text{DISTANCE} (W_o = FD)$$

$$\text{OBVIOUS POWER} = \text{OBVIOUS WORK} \div \text{TIME} (P_o = \frac{W_o}{T})$$

$$\text{OBVIOUS FORCE} = \text{MASS} \times \text{ACCELERATION} (F_o = MA)$$

[macroscopically-observable MASS X ACCELERATION]

$$\text{UNOBVIOUS WORK} = \text{FORCE} \times \text{TIME} (W_u = FT)$$

$$\text{UNOBVIOUS POWER} = \text{UNOBVIOUS WORK} \div \text{TIME} (P_u = \frac{W_u}{T})$$

$$\text{UNOBVIOUS FORCE} = [\text{STATIC}] \text{FORCE} (F_u = [S]F)$$

[molecular, atomic, and/or sub-atomic MASS X ACCELERATION]

$$\text{OBVIOUS KINETIC ENERGY (OKE)} = \text{TOTAL OBVIOUS ENERGY}$$

$$\text{UNOBVIOUS KINETIC ENERGY (UKE)} + \text{POTENTIAL ENERGY (PE)} = \text{TOTAL UNOBVIOUS ENERGY}$$

The above mathematical formulas *do* correspond with the facts. They satisfy all previous requirements as well as the example of the man supporting a 400-pound mass. The man *did* produce Unobvious Work, Unobvious Power, Unobvious Force, and Unobvious Kinetic Energy. He *did not* produce Obvious Work, Obvious Power, Obvious Force, or Obvious Kinetic Energy.

The L. Pearce Williams biography on Michael Faraday states that during the early years of Faraday's intellectual development, Faraday was very impressed with a book written by Dr. Isaac Watts entitled, *The Improvement of the Mind*. As a disciple of John Locke, Dr. Watts continually emphasized the importance of the observed fact and the dangers of imprecise language. In his book, *The Improvement of the Mind* [published in London, 1809], Dr. Watt cautions the student to carefully distinguish between words and things lest he "feed upon husks instead of kernels." Dr. Watt's emphasis upon careful observation and precisely described facts equipped Michael Faraday with a seemingly infallible guide, *i.e.*, the essence of the scientific method. I wish to provide you, the reader, with the precise, mathematical equations which I have presented above in order to permit a better scientific understanding of matter.

26

F. It can now be scientifically observed from the facts that *all* static forces and *all* potential energies exist as a result of continuing, Unobvious Kinetic Energy. (Verify this fact by observing the Unobvious Kinetic Energy *internally* produced within the man as long as he supported the 400-pound mass on his shoulders.)

There are additional observations which verify the

existence of Unobvious Kinetic Energy: materials both fatigue and break/collapse from supporting a force. Gas molecules "heat up" when compressed by a force. Such observations prove that materials react with Internal, Unobvious Kinetic Energy when a static force or Potential Energy is exerted against them.

26

G. To improve your understanding of my statements, consider Einstein's equation of $E = MC^2$. The nature of the mass-energy relationship is such that the mass (and weight) changes associated with Potential Energy conversion into Unobvious Kinetic Energy (which oc-

"It can now be scientifically observed from the facts that all static forces and all potential energies exist as a result of continuing, Unobvious Kinetic Energy."

curs internally within matter) is immeasurably small. Consider also that the gyroscopic-action-entity represents the Mechanical Essence of Einstein's equation of $E = MC^2$ and that the mathematical formulas I present properly account for the existence of the gyroscopic-action-entity.

EXAMPLE:

Newton's Third Law of Motion states: by the law of Action and Reaction, a Force must be resisted by an Equal and Opposite Force.

What does the mathematical term "equal" really mean? It means "identical in mathematical value or logical denotation; equivalent."

FIGURE 26-G

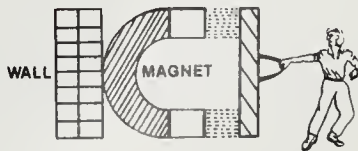

According to Newton's Third Law: if I hold an iron material at a distance (see Figure 26-G) from a strong, permanent magnet (causing me to resist a constant attraction force of 200 lbs.) — what happens to me? I must use Unobvious, Internal Kinetic Energy to continually resist the attraction force of the permanent magnet. According to Newton's Third Law, the magnet must *also* be utilizing Unobvious, Internal Kinetic Energy to produce the constant attraction force, *i.e.*, an "equal" action and reaction!

If the magnet were *not* to react with Unobvious, Internal Kinetic Energy, then Newton's Third Law would be defied. In resisting a continual, attraction force, I had to expend a constant, Unobvious, Internal Kinetic Energy. If the magnet produced a constant attraction force and did *not* utilize any Unobvious, Internal Kinetic Energy, then such observed results would be "opposite" and not "equal." Hence, such a conclusion would be obviously incorrect.

The Facts clearly show that the atoms within myself, the magnet, the iron material, and the wall all produced "Unobvious Work, Force, and Power." There was no "Obvious Work, Force, or Power" produced.

26

H. I have presented more precise mathematical equations which are conducive to an improved scientific comprehension of Matter in accordance with the Mechanical Essence of Einstein's Equation of $E = MC^2$. Such a mechanical essence is represented by the *gyroscopic-action-entity* which is the basic building entity of all matter.

26

I. A PIONEERING SOURCE OF ENERGY:

Consider once again the equations $Wu = FT$, $(Pu = \frac{Wu}{T})$, and $Fu = [S]F$.

A permanent magnet "X" that attracts an object "Y" with a constant force of 200 lbs., twenty-four hours a day for 30 days will have performed the following:

$$Wu = (200) \times (60 \text{ sec.}) \times (60 \text{ min.}) \times (24 \text{ hrs.}) \times (30 \text{ days})$$

$$Wu = 518,400,000 \text{ lbs.-sec.}$$

$$Fu = 200 \text{ lbs. constant}$$

$$Pu = 200 \text{ lbs. constant}$$

The gyroscopic energy in the magnetic field produced Unobvious Work, Unobvious Power, and Unobvious Force. The magnetic field also maintained Potential Energy via the use of Unobvious Kinetic

Energy to accomplish this task. The mass loss is not easily measurable since we are describing the effects that generate atomic energy. As you know, we are discussing $E = MC^2$. The existence of the Gyroscopic-Action-Entity exactly fits the First Law of Thermodynamics since it appears this Entity cannot be created or destroyed.

The present utilization of atomic reactors as a source of energy production is extremely inadequate for the demand.

The energy machine I have innovated has *no* harmful side effects*, will cost little, and will be small in size compared to a nuclear reactor. All that I have written has been based upon the concept of the gyroscopic entity on which I started working in 1965. Since that time I have sought to prove or disprove this concept. The more I have learned, the more certain I became of its truth.

If you have Mastered what I teach, then you must recognize the reality of my Pioneering Invention. However, the access to an unlimited source of energy is not by any means the ultimate discovery!

The energy machine I have innovated simply uses Universal Energy (the gyroscopic-action-entity). Such utilization must occur if man is to end his stupidity, hunger, greed, and wars — and advance to other solar systems! Consider how long it took our Species to discover how to harness the motion of flowing water via a simple waterwheel.

It has been obvious to me that what I have seen so clearly was unimaginable for most people. What I have seen is, at the very least, equal to the effect of Einstein's equation of $E = MC^2$. It gives me much contentment if you now understand what I have presented. This is the purpose of my Book.

**Note:* There are no harmful side effects because the size of the gyroscopic-action-entity is *so small* that it easily passes through the atomic structure of living tissue. In nuclear fission, the sub-atomic particles (representing agglutinations of gyroscopic particles) are *far larger* and can do damage to the atomic structure of living tissue. By analogy, if one threw a dust particle at a large fishnet, the particle would easily pass through the net. However, if one attempted to pass a large boulder (composed of millions of dust particles) through the same fishnet, it would cause damage to the net. By another analogy, my energy machine — in its utilization of nuclear energy — differs from conventional nuclear energy sources in the following manner: I have discovered a previously unknown source of "underground, unique running water." I have therefore devised a "waterwheel" (my energy machine) to tap into this existing energy of unique running water (the continual motion of the gyroscopic particles). The conventional nuclear energy approach would be to secure a cup of normal water and attempt to "smash" the normal water with a hammer to extract the atomic energy from the water. My process is 100% (conversion) efficient and harmless (due to the minute size of the gyroscopic particles). Conventional nuclear fission is less than 1% efficient and harmful (due to the larger size of the released particles).

Chapter 13

THE STATIC EMBODIMENT

(ENERGY MACHINE)

27. **T**he reader should now become aware that other physical embodiments of my Pioneering Invention can result by securing the proper**, atom-oriented, current-carrying materials which have a proper geometric design, and are placed within the magnetic field of a permanent magnet.

²⁷
A. QUESTION: How does one explain the effect of Lenz's Law which states that "the current induced in a circuit due to a change in the magnetic flux through it or to its motion in a magnetic field is so directed as to oppose the change in flux or to exert a mechanical force opposing the motion."

ANSWER: Simple. If a proper, atom-oriented material (with the proper atomic [geometric] design) was placed within a magnetic field of gyroscopic-action-particles (which move at C and spin at C) in a configuration which caused current (gyroscopic particles) to flow, then it would be necessary to physically secure the proper, atom-oriented material within the Unobvious Magnetic Force Field. If not secured, then the proper, atom-oriented material would be physically repelled and the energy transfer of gyroscopic particles would cease.

[Earlier in this Book, I have demonstrated that Lenz's Law was only an observation which in fact described those gyroscopic particles deflected from a magnetic field. Because such deflection occurs, it can be concluded that the spin of such gyroscopic particles is at right angles to the spin of the gyroscopic particles which remain within and comprise the magnetic field itself.]

Such physical repulsion of the proper, atom-oriented material is in accordance with Newton's Law of Action and Reaction!

***Note:* By the term "proper," I am referring to a mechanical understanding (of both the motion of the gyroscopic particles comprising a given electromagnetic field surrounding a magnet and the motion of the gyroscopic particles within the atoms of the proper material) which permits one to construct an energy machine designed for the efficient utilization of the maximum number of gyroscopic particles existing within all interacting systems, *i.e.*, the stationary magnet's kinetic magnetic field and the proper material.

In addition, the specific atomic structure (physical orientation) of the energy machine's materials — such as the proper material — will differ from element to element or compounds in terms of how such varying atomic structures (containing billions of gyroscopic particles) will deflect exterior gyroscopic particles impinging upon the gyroscopic particles contained within such atomic structures.

"New and stirring things are belittled because if they are not belittled, the humiliating question arises: Why then are you not taking part in them?"

— H.G. Wells

²⁷

B. I have not physically constructed the STATIC ENERGY MACHINE design just described, but this does not alter the fact that what I teach outlines the means for such construction.

SAMPLE DESIGNS:

(1) I should recommend utilizing a uniform magnetic field as evidenced by that generated with a strong, horseshoe magnet or other means. (See Figure 27-B.)

(2) The utilization of a proper, atom-oriented coil with the correct geometric design is critical to the success of the system. It would be better to have only one side of the coil within that particular magnetic field to avoid the "cancellation effect." (See Figure 27-B.) [There could be additional magnets placed in proper current polarity around the proper, atom-oriented coil.]

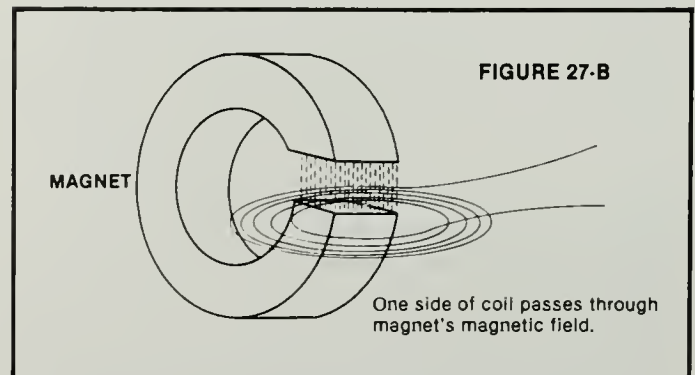

(3) With respect to the question of producing the proper, atom-oriented material, it should be noted that when formed by conventional production techniques, *i.e.*, the use of heat, most materials appear to align their atoms in random directions.

²⁷

C. ONE METHOD OF CREATING THE PROPER, ATOM-ORIENTED MATERIAL:

As Michael Faraday proved, neutrality to a magnetic field *does not exist!* All materials are aligned parallel or across lines of Unobvious Force when such materials are suspended within an extremely powerful magnetic field. If a material undergoing atomic formation is cooled within this powerful magnetic field,

then the atoms of the material will assume a particular alignment. The atom-alignment-direction of the material could be changed if the magnetic field was aligned at 90° to the material or at *any* degree less than 90° to the material. Such induced atom-alignment would result in the atoms (of a given material) containing gyroscopic-action-entities having orientations principally along the same axis and at any

“Even the slightest degree alteration in atomic-axis-alignment can produce a significant change in results obtained.”

desired angle of atom alignment with respect to the proper material's length. Thus, such material would possibly become a proper, atom-oriented material.

²⁷
D. I again stress that nothing in the energy system's design can be taken for granted! Even the slightest degree alteration in atomic-axis-alignment can produce a significant change in results obtained. Refer to Sections 25-F through 26, and you will observe visual facts which confirm the truth of this statement.

²⁷
E. However, merely having atom-alignment is insufficient to produce the desired results. The utilized material (with its particular atom-alignment) should produce very little (if any) magnetic field (gyroscopic particles) in the surrounding area beyond the physical dimensions of the material itself. It is obvious from the facts of science that different materials produce results which vary significantly. (As proof of this, simply look at the wide diversity of conductors, semi-conductors, and non-conductors.)

²⁷
F. It is very likely that the proper, atom-oriented material will have a different atomic alignment than that of a conventional magnet containing atoms generally aligned along a certain axis which causes the release of an External Magnetic Field. In the proper, atom-oriented material, the magnetic energy (resulting from such atom orientation [alignment]) will be primarily contained within the physical boundaries of the material itself. The intent of such a system is to have the gyroscopic particles of the External Magnetic Field interact with the atoms comprising the proper, atom-

“In the proper, atom-oriented material, the magnetic energy (resulting from such atom orientation [alignment]) will be primarily contained within the physical boundaries of the material itself.”

oriented material. This will result in the proper Force being applied to the axis of those gyroscopic particles being emitted from the external, magnetic source. When this occurs, the gyroscopic particles (from the

external magnetic source) will move at right angles to that proper Force, but all particles will move in the *same* direction. [It may be desirable to have fine conducting wire impregnated within the proper material.]

²⁷
G. Ordinary materials may be possibly converted into proper, atom-oriented materials by subjecting the ordinary material to cryogenic temperatures. Such temperatures would reduce the random atomic motion within the material and cause the atoms to move towards a general axial alignment.

²⁷
H. In addition to other methods, one can employ contained, high pressures (or stresses) to possibly produce atom alignment. The atoms of all materials will react to a sufficient, external force.

²⁷
I. In effect, it will be essential to develop the correct techniques for the production of proper, atom-oriented materials which achieve an atom alignment possessing internally-contained force fields which can be coupled with the Proper Geometric Design of the system. Such a system will generate the controlled release of electrical energy from magnetic fields of Unobvious Force when the proper, atom-oriented material is *physically secured* within the lines of Unobvious Force comprising the External Magnetic Field.

To create such a system will require standard testing as demonstrated in the 19th Century by Thomas Edison's perfection of the design for the light bulb.

The atoms of a conductor align at right angles to the input current in a circular configuration within the conductor. By the time this Book went to press, Mr. Newman had developed a detailed explanation of this process which will be presented in greater detail in the Second Edition.

Chapter 14

EFFECTS DEMONSTRATED BY PARTICLES WITHIN ELECTROMAGNETIC FIELDS

28. I will now discuss another EMBODIMENT of my Pioneering Invention.

²⁸
A. The following is a DECLARATION by Dr. Roger Hastings (who deserves the reader's respect):

DECLARATION

April 29, 1982

Mr. J.W. Newman has shown me a demonstration in which lead powder placed gingerly onto the surface of water exhibits a most interesting property. Nearly microscopic streamers of lead immediately flow down into the water from the lead dust on the surface. Viewed under the microscope, the particles in the streamers appear as brilliant sparks of light. The streamers swirl in a vortex motion. Having believed that lead is inert to water, this demonstration gave me considerable surprise, and markedly raised my opinion of Mr. Newman as a Scientist. My graduate and post-doctoral training was in the field of condensed matter (solids and liquids), and I am quite certain that Mr. Newman's discovery would generate considerable excitement in this community of scientists. Applications of this discovery are very likely to be forthcoming. (Mr. Newman has already described an application in his declaration witnessed by his patent attorney, Mr. Pugh, on Aug. 1, 1979.)

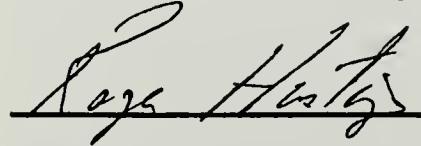

Roger Hastings, Ph.D.
Principal Physicist
Sperry Univac Corporation

WAIVER

I am acting on my own in matters related to Mr. Newman's inventions, and am in no way representing Sperry Univac Corporation.

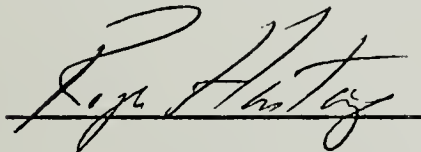

Roger Hastings, Ph.D.

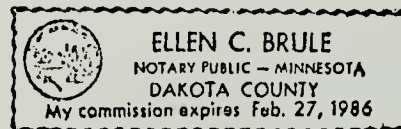

²⁸
B. The reader should realize that chronologically, the technological development of my Pioneering Invention occurred in the following sequence:

- (1) The **GAS EMBODIMENT**
(described in Section 28-F)
- (2) The **STATIC EMBODIMENT**
(described in Section 27A-I)
- (3) The **CONDUCTING-COIL EMBODIMENT**
(described in Sections 15 - 22)

The fact that I have developed three *different* EMBODIMENTS of my Pioneering Invention proves that I have more clearly understood the "mechanical"

essence of the gyroscopic-action-entity (acting in accordance with Einstein's equation of $E = MC^2$), the nature of matter, and the nature of a magnetic field than those who utilize concepts taught by the Prior Art. Such is true because the facts clearly verify the validity of the "Mechanical," Technical Process which I teach — a process which adheres to the established Scientific Method. Let the facts verify my predictions; the result is a "Pioneering Invention."

²⁸
C. I will now insert my technical papers referring to the process described by Dr. Roger Hastings in Section 28-A. These papers were witnessed by Mr. Emmett Pugh (my Patent Attorney with a physics background) on August 1, 1979 and were forwarded by Mr. Pugh to the U.S. Patent Office.

PROTOTYPE PROOF OF MY PATENT APPLICATIONS PENDING ON AN UNLIMITED SOURCE OF ENERGY.

Attached with my Energy Patents Pending, there is a Scientific Document that I have written. Pages 6 through 12 of that Document state that gravity is the unobvious effects of electromagnetic energy and that matter is held together and attracts and repels other matter electromagnetically.

Pages 12 through 21 explain electric charge, magnetism and electricity and in conjunction with my Energy Patent Applications explain and disclose how an Unlimited Source of Energy can be released from electromagnetic fields of force.

The Patent Examiners have recently turned down my Energy Patent Applications on the basis of wanting to see a working model.

The following disclosure demonstrates this working model:

It is presently stated in physics that it is virtually impossible to see any details of particles in suspension without an electron microscope.

It is also presently stated the only movement observable of particles suspended in water is in accordance with Brownian Movement which uses microscope of 500 to 1,000 times enlargement with drop of water on a slide, and any movement observed is so slight, it is doubted by some observers.

As a result of my many years of work and in accordance with my Energy Patent Applications Pending, I concluded the following:

I know the only way I was likely to easily and inexpensively get material movement as a result of interaction with the gyroscopic particles moving in electromagnetic fields of force was to get particles of minute size. Thereby, when the proper material minute particles were struck by the gyroscopic particles moving in an electromagnetic field they would have an electric current induced into them; which would create an expanding magnetic field and as a result of the combination of this effect coupled with the gyroscopic particles of the electromagnetic field moving at right angles to any resistive force they encounter the particles should have a pivoting action.

Accordingly, therefore, I did the following:

I took several different metal materials and filed off small particles of each metal which I floated on water in different glass bowls for different metals.

I observed that all the metal particles attracted each other and that they resulted in always forming a crystal structure on top of the water. I tried Silver, Gold, Aluminum, Bismuth, Iron, Brass, Copper, Zinc and Lead.

I observed there were times when a magnet was rotated above any of the material some of the particles would become extremely magnetic and just as quickly lose this property. I also observed that when one end of the magnet was stuck in the water close to the metal particles floating, they would all shoot away from the magnet along the curved lines of force which was in a

straight line from the center of the end of magnet and 360° around the end of the magnet. I also found this effect could be neutralized after 3 or 4 dunkings of the magnet. But could be reactivated if the magnet was rotated above the particles again.

These results gave me no doubt electromagnetic energy was being generated throughout the distilled water which is an extremely poor conducting medium. I, accordingly, took a flashlight with a magnifying glass for making a concentrated light beam and made the room dark. I found no obvious results with Gold, Silver, Copper, Zinc, Aluminum, Iron or Bismuth. However, with Brass and Lead I did find the results I had predicted in my Energy Patent Applications and Scientific Document!

From the metals of Brass and Lead I observed streamers coming from the floating metal particles on top of the water. The streamers consisted of a web appearance dotted profusely with tiny metal microscopic particles or groups of atoms which came from the above floating metal.

I concluded that these groups of metal atoms were pulled out of the floating larger metal particles because the total electrical attraction of the water molecules were greater than the total electrical attraction the metal atoms had for each other in the small floating metal particles. I verified this as fact by suspending a large piece of the metals of Brass and Lead; and this result was not observed, except when I put rough or sharp edges on the metals. (You will observe this result fits exactly as I predicted in pages 6 through 12 of the Scientific Document attached with the Energy Patent Applications).

Of great scientific importance and scientific breakthrough is the observable fact that these minute metal particles attracted down into the water have an obvious energetic pivoting or flickering motion when observed by a flashlight beam. There are continuous convection currents also, but not near so exciting. This is exactly the results I had anticipated and built the prototype for! This also satisfied the exciting results I have predicted in my Energy Patent Application.

To be sure this effect was not caused by light, photoelectric effect, I set up the prototype in the dark and let sit for one hour and when I turned on the flashlight the particles were all already pivoting even when light was swung through test. Even when light is not directly on metal atoms they can be seen pivoting with same enthusiasm. The opposite was also done, the filings were put under bright light and then placed in water while under light and then put up close to light source and let sit for one hour under light and results were still the same.

Also knowing the mass of light is extremely hard to detect, in past sensitive experiments designed just for such purpose. And knowing the atoms of the test are extremely heavy (Mass) inertia effect compared to mass and lack of inertia displacement ability of light (a thin small light piece of tissue paper when suspended by a thread will not move when a strong light beam is shown on it). However, in extreme contrast, the Earth's electromagnetic field will quickly align my large 90 pound

magnet even when suspended by a rope! Also the streamers are affected when a magnet is put up next to the glass bowl containing the test.

To be sure this vigorous pivoting action of the minute metal particles was not a chemical reaction, I tested with litmus paper and, in addition, observed there was no noticeable difference in the appearance of the metal particles electroplated on the wall of the glass bowl.

I also was impressed that when copper and zinc filings were put in same bowl, there was an electrolysis effect and floating particles had thick fungus-looking substance on the under side. However, absolutely no pivoting action could be seen of the particles in suspension.

Also lead is noted for its chemical resistance, even against sulfuric acid.

Also impressive is the fact that when Copper and Zinc are heated to the point of combining their atoms to form Brass, the atoms of Copper and Zinc cannot be distinguished between. Which proves as I have predicted, atom alignment of a material is relative to gyroscopic particles moving in an electromagnetic field reacting with the material atoms and producing an electric current!

Therefore, the results of this prototype prove the atoms of the metal suspended in the water are affected by the gyroscopic particles moving in the Earth's or any electromagnetic field of force as I have continuously predicted they would be in my 120 page Scientific Document and two Patent Applications on Unlimited Source of Energy from electromagnetic fields of force! This is also proved by the electrical field that exists in the water relative to the filings floating on the water which are repelled when a magnet is stuck in the water. These are also the results I was looking for and predicted before I ran this new scientific breakthrough prototype and was the exact reason I went to small filings in that I had hypothesized from my many years of work that I should get particles of minute size to easily and inexpensively see any obvious results from the effects of the continuous energy of electromagnetic fields of force. This prototype has proven the exact results I explained in my Patent Applications.

The prototype also indicates the following basic possibility law:

The maximum kinetic energy of each gyroscopic particle (due to its velocity) that is moving at C in the electromagnetic fields of force of the Earth or any source is independent of the intensity of the electromagnetic field of force. And, therefore, the pivoting action of the metal atoms in the test that are hit by the gyroscopic particles moving in an electromagnetic field are the result of the laws of a gyroscope moving at right angles to the force applied to it and in conjunction with the present laws of electromagnetic induction. The metal atoms consists of electromagnetic energy as does the electromagnetic fields of force and they react to one another when they collide, resulting in pivoting action of metal atoms in the prototype. The gyroscopic particle moving in the electromagnetic field attempts to spin the metal atom it strikes, which is resisted, therefore, results in the gyroscopic particle moving at right angles to this resistive

force, which produces electric current in the metal particle, which also produces an expanding magnetic field which induces an electric current in neighboring metal particles and opposing magnetic field which causes pivoting, but when electric current in first metal particle is subsiding, its associated magnetic field then is collapsing and, thereby, induces electric current in opposite direction in neighboring metal particles which attract, thereby, causing pivoting back toward original position. This effect is taking place throughout the entire prototype and in addition is mirrored back and forth among the entire prototype resulting in a fantastically energetic pivoting action in all directions of the minute metal particles throughout the prototype.

Another fact that proves electricity is being produced is that the entire inner wall of the glass bowl eventually becomes lightly and evenly electroplated with metal atoms after about 24 hours. (Even when distilled water is used.) Consider now Faraday's First Law of Electrolysis:

The weight of any material deposited on the cathode during electrolysis is directly proportional to the quantity of electric charge passing through the circuit.

This law states that the weight of a substance deposited is proportional to the quantity of electricity.

All of the above proves beyond any doubt I have disclosed a working prototype of my invention explained in my Energy Patent Applications and a Scientific Breakthrough that has never been disclosed and explained before on this earth.

I have succeeded in disclosing a new invention which those skilled in the art by taking this, my Energy Patent Applications and attached Scientific Document will be able to make many obvious improvements upon. (Such as new type batteries, capacitor, etc., utilizing (Gravity) electrical fields and magnetic fields.) However, I am most certainly entitled to my first patent Claim and all other claims as I have shown a completely and totally new invention which will result in being the most beneficial invention ever put forth for this Earth before now! I have accomplished all of this with virtually no scientific equipment, it is obvious what can be now accomplished with proper financing and scientific equipment.

Joseph Westley Newman

This document was presented to me and read by me in association with a series of demonstrations by Mr. Joe Newman, all of which took place on this August 1, 1979.

Witnessed
This August 1, 1979
8/1/79

Chapter 15

THE GAS EMBODIMENT

(ENERGY MACHINE)

28

D. My mechanical understanding of the "gyroscopic-action-entity" composition of all matter combined with my natural curiosity regarding the nature of electrical storms, led me to the development of the GAS EMBODIMENT for my Pioneering Invention.

The following facts concerning electrical storms stimulated my thoughts:

(1) Jupiter possesses a strong magnetic field. Powerful, electrical disturbances occur within its atmosphere and intense bursts of radio waves are emitted from such disturbances.

(2) The Earth also possesses electrical storms, but of less intensity than those on Jupiter.

(3) I then asked myself: why the electrical-intensity difference between the two planets? I also observed that both the gravitational (Unobvious Effects of Electromagnetic Energy consisting of gyroscopic particles) and magnetic fields of Jupiter are substantially greater than those on Earth. In addition, both the atmospheric composition and pressure of the two planets differ. I then concluded that the two planets' electrical storms differ in intensity and frequency as a result of differing Magnetic Fields, gases (atmospheres), gas pressures, temperatures (possibly), and rotational speeds.

28

E. I then studied the known facts concerning Earth's electrical storms. Those facts which I found interesting include the following:

(1) Thunderstorms are the largest and most spectacular atmospheric electrical generators. The mechanism responsible for such electrical activity is very complicated.

(2) The motion of air across the Earth's Magnetic Field produces an Electric Field in the atmosphere (gases). Within the highly conducting regions of the lower ionosphere, this process is called the "dynamo effect" and it is responsible for larger electrical currents which are studied at the Earth's surface by means of the magnetic fields which such electrical currents produce. [However, within the lower at-

mosphere, the fields produced by the dynamo effect are several orders of magnitude less.]

(3) In drier climates, dust storms produce surface electrical fields much greater than the normal field and are characteristically oriented in the *opposite direction* from the normal field. (Other examples of this opposite-direction-effect are snowstorms and smoke/steam blown from locomotives.)

(4) All ions participate in random molecular motion. When an electric field is created in the atmosphere, the electric field superimposes (upon the random, atmospheric motion) a "drift velocity" *in the field's direction* when the ion charge is "positive," and *opposite to the field's direction* when the ion charge is "negative." The actual conduction currents flowing in the medium depend upon the established Electric Fields.

(5) It has been determined that updrafts and downdrafts (high winds) in clouds and storms consist of separate electrical charges! By what I teach, *this means that one draft consists of "negative" charges and the other draft consists of "positive" charges!*

One can understand why I was stimulated by Fact 28-E(5), since it coincides precisely with my explanation of the behavior of gyroscopic particles (In a magnetic field) which travel in opposite directions "like cars on one-way streets." Such mechanical behavior generates an effect which causes the outside observer to perceive a gyroscopic-action-entity as "negative" at one instant and "positive" at another instant in time.

It was obvious to me that Fact 28-E(5) proved that the updrafts and downdrafts actually represented a *circular motion*. By placing electrically-sensitive instruments in the path of such activity, the circular motion would appear as "negative" or "positive" depending upon the frame of reference of the observer.

28

F. Combining the knowledge I had acquired, I applied for a Patent for the First (GAS) Embodiment of my Pioneering Invention in March, 1979. The following are drawings and instructions from my Patent Application 179-474 for my First Embodiment:

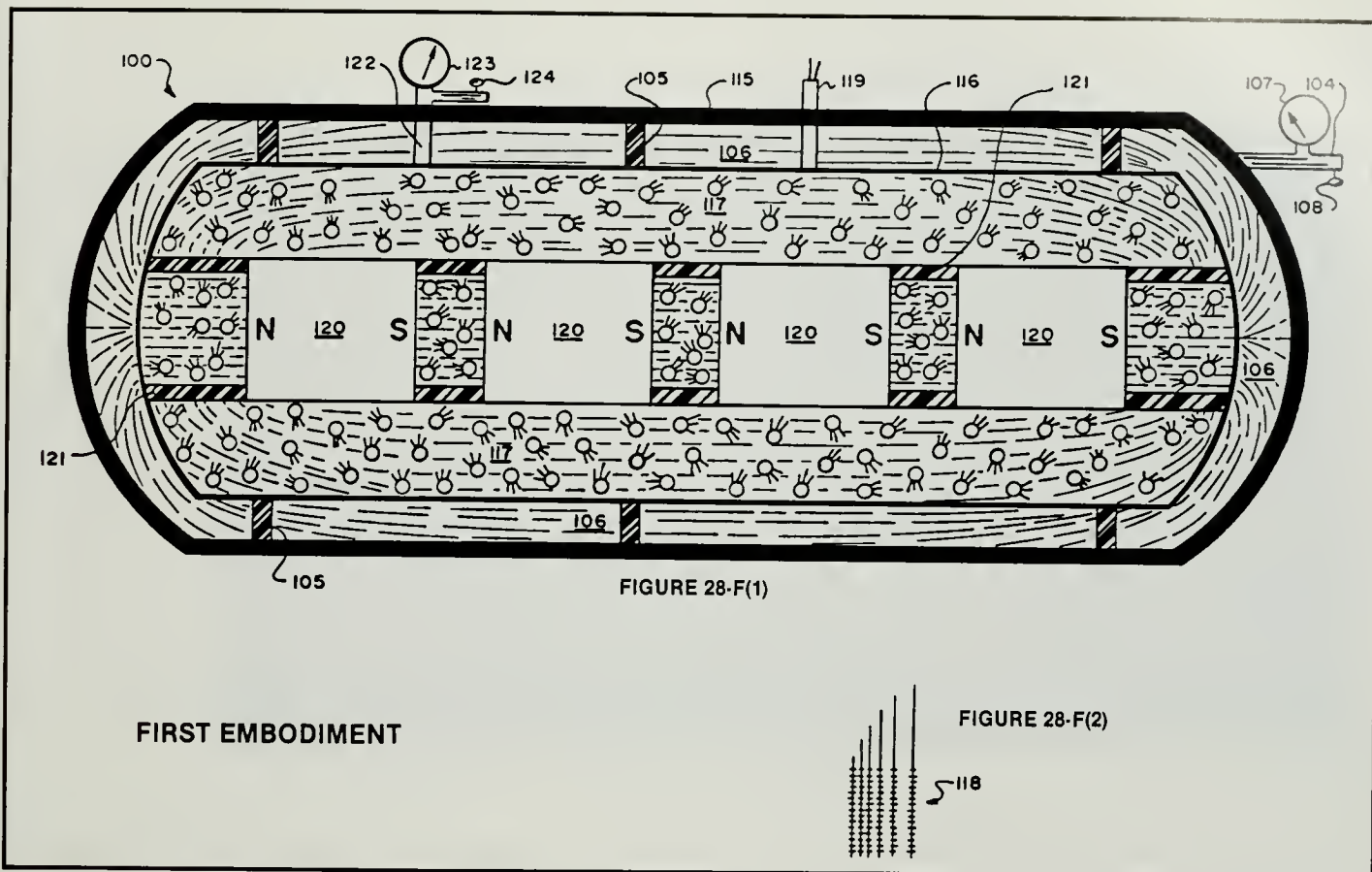

FIRST EMBODIMENT

FIGURE 28-F(1)

FIGURE 28-F(2)

FIRST EMBODIMENT (Figure 28-F1)

One possible, exemplary embodiment using the principles of the system of the present invention is schematically shown in the generalized illustration of Figure 28-F1.

As illustrated in Figure 28-F1, there is provided an electrical current generator 100 comprising an outer keeper housing 115 and an inner, pressure-containing, closed housing 116 supported therein by insulating supports 105. A vacuum exists in the area 106 between the two housings 115, 116, which vacuum is regulated and induced by means of the vacuum line 104 with its gauge 107 and its control valve 108. The outer housing 115 acts as a keeper for magnetic fields of force, and can be made, for example, of soft iron, while the vacuum in area 106 prevents the leakage or discharge of static electrical charges which might build up on the exterior of the inner housing 116.

A gas or gas-liquid mixture 117 which may also include solid particles such as, for example, lead or brass filings, is included within the inner housing 116 surrounding a series of aligned magnets 120 carried by insulating braces or supports 121 and producing a high, combined electromagnetic field. The magnets 120, which can for example be cryogenic magnets, have their "north" and "south" poles aligned (as illustrated by the "Ns" and "Ss") so that their magnetic fields reinforce one another.

The level of the gas or gas-liquid mixture 117 in the

housing 116 is regulated by means of the line 122 with its gauge 123 and control valve 124. Electric current output wires 119 are provided and extend down to electrically connect with a wire pick-up system 118 (shown in close-up in Figure 28-F2), which can be for example in the form of very small wires forming a closely-spaced network or mesh or of a porous conducting metal body or sheet, located in and extended throughout the fluid 117 in the housing 116.

It is noted that a thimbleful of gas contains a fantastically large number of extremely tiny bodies which are in continuous, random motion moving at extremely high speeds. Hence, the fluid 117 continuously applies a force to the gyrosopic particles (comprising the magnetic field as described in Chapter Three) moving at the speed of light in the high electromagnetic field (produced by the magnets 120) as they continuously collide with each other, which results in the fluid 117 becoming electrically charged. The charged fluid 117 discharges its electrical charge to the pick-up wire network 118 positioned in the fluid, and the electric current so produced and generated is taken off for use via the electrical output wires 119.

As an alternative to having internally-contained magnets 120, the electromagnetic field needed in the fluid 117 could be produced by a source located outside of the confines of the fluid 117 as long as a significant field was produced within the fluid 117.

FIGURE 28-H

Lead or Brass Filings (powder) on Surface of Water

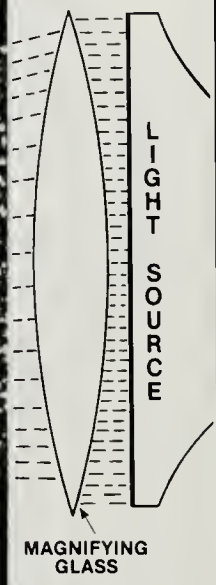

Clear Container of Distilled Water

28

G. The FIRST EMBODIMENT (discussed in Section 28-F) can be developed to produce significant results. The first step would be to construct a design (at least) 8 feet tall and 16 feet long which is capable of withstanding “high” and “low” pressures. One should utilize a strong magnetic field(s) and test a variety of pressures, materials, gases, fluids, etc. A monitoring or viewing area would be important to study the internal reactions. The height and length of the EMBODIMENT would permit observable and more distinct circulation of the medium.

28

H. I now refer back to the lead powder demonstration discussed in Sections 28-A and 28-C. A demonstration conducted as I described will provide the exact results as seen in Figure 28-H. Observe the remarkable resemblance to astronomical photographs which depict those star systems enveloped within a gas (web appearance) undergoing stellar birth.

FACT: Figure 28-H is in fact an astronomical photograph and yet *this picture represents the exact formation and action one will witness when conducting the experiment described in Sections 28-A and 28-C!*

How unique it is that if we “open our minds” we can observe — in miniature on Earth — a process which produces a reflection of what possibly occurs on a much grander scale in the Universe. I find it very difficult to believe that such interesting results are “pure coincidence.”

Actually, those who observe this test become enthralled, since it is like experiencing the feeling one enjoys upon viewing the sky on a clear night.

If you, the reader, have Mastered what I have taught, then you should be inspired. You should also “peacefully and responsibly” recognize the significance of what you have Mastered. I would now recommend that you “prepare your mind for more.”

Chapter 16

GRAVITY

"If it should be said that the physical nature of gravitation has not yet been considered, but only the law of its action, and, therefore, that no definition of gravity as a power has hitherto been necessary; that may be so with some, but then it must be high time to proceed a little further if we can ..."

— Michael Faraday

By this point in the Book, the reader should recognize what gravity represents. As an introduction to what I will present, I wish to pay tribute to Isaac Newton and quote those words which demonstrate his mental clarity and profound insight:

"It is inconceivable, that inanimate brute matter should, without the mediation of something else, which is not material, operate upon, and affect other matter without mutual contact . . . and is one reason, why I desired you would not ascribe innate gravity to me. That gravity should be innate, inherent, and essential to matter, so that one body may act upon another, at a distance through a vacuum without the mediation of anything else, by and through which their action and force may be conveyed from one to another, is to me so great an absurdity, that I believe no man who has in philosophical matters a competent faculty for thinking, can ever fall into it ... "

— ISAAC NEWTON

[from the *PRINCIPIA*, published by the University of California Press, Los Angeles, 1934, page 634 of the Appendix.]

29. A. I will now demonstrate that Gravity — as you may already realize — represents the Unobvious Effects of Electromagnetic Energy.

EXAMPLE: If a *single* "negative" and a *single* "positive" charge are physically separated from one another $\ominus \oplus$, one could easily detect their existence as electrical charges. However, if the two separate charges are joined, then one would have a mass of $\oplus\ominus$ which neutralizes the *Obvious* electrical characteristics possessed by the charges when physically separated.

Visualize two, separate masses of \oplus and \ominus . Neither mass would demonstrate *Obvious* electrical characteristics. But consider what occurs (with respect to the attracting and repelling forces of those two physically separate masses) when they are brought close to one another:

FIGURE 29-A

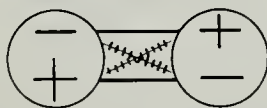

In Figure 29-A, the positive charge within each mass attracts the negative charge and repels the positive charge of the other mass. In addition, the negative charge attracts the positive charge and repels the negative charge of the other mass.

²⁹

B. WRONG CONCLUSION from observing Figure 29-A: The attraction and repulsion forces of the two, separate masses are equal; therefore, they would neither attract nor repel.

²⁹

C. RIGHT CONCLUSION: *The unlike charges will seek to obtain the least possible distance between themselves with respect to the two, separate masses; and the like charges will seek to obtain the greatest possible distance between themselves with respect to the two, separate masses.* [Remember that the charges being simultaneously repelled are also being simultaneously attracted and such charges cannot physically move far from one another.]

Consider the implication of the Inverse-square Law with respect to the attracting or repelling force of charges. The most dominant forces are those *between* the charges existing *within* each separate mass. Consequently, the attraction force is greater than the repulsion force between the two separate masses — but (as an order of magnitude) *this difference is unimaginably small.* [A simple mathematical analogy demonstrates this "unimaginably small" difference: If we assign to

equal attraction and repulsion forces a “unity of 1,” then the difference (in the attracting forces being greater than the repulsion forces) would be an extremely small percentage of such “unity of 1,” e.g., only .00001.]

Such a small difference is clearly demonstrated by the fact that the attraction force of Gravity (the observed effect of the interaction of unobserved electromagnetic fields comprising Matter) is extremely less than the (“unity of 1”) attraction/repulsion forces of *Obvious* electrical charges as well as those same forces (gyroscopic-action-particles) which comprise magnetic fields or Matter itself.

“As a result of such Unequaling Forces, the attraction force is always minutely greater than the repulsion force.”

²⁹
D. I hypothesize that the following represents the Law of Gravity with respect to the Inverse-square Law: The difference in the Unequaling Forces (in accordance with the law of distances sought between “like” and “unlike” gyroscopic-action-particles) of the two, above-mentioned masses causes a Force of Gravity to be a very small percentage (example only: .0001 of a “unity of 1”) of the equally attracting and repulsion forces having a “unity of 1.” [Refer to Section 25-E.) Such equal forces (with a “unity of 1”) represent a balance of all the “negative” and “positive” gyroscopic-action-particles comprising all Matter. [I remind the reader that such “negative” and “positive” gyroscopic-action-particles are actually composed of only one type of gyroscopic-action-entity which appears to move in opposite directions depending upon the frame of reference of the observer.]

As a result of such Unequaling Forces, the attraction force is always *minutely greater* than the repulsion force. Such an inequality of forces is still incredibly less than the attraction/repulsion forces of *Obvious* electric charges or magnetism which have a “unity (force) of 1.”

NOTE: For the convenience of expression, I am arbitrarily assigning this “unity (force) of 1” value to electric charges and magnetism in order to provide the reader with some subjective means to distinguish such forces from the very weak gravitational force which would have — as an order of magnitude — a value of approximately .0001 based upon the above forces having a value of “1.”]

²⁹
E. It should be clear that such Unequaling Forces occur regardless of mass size or number. This minute attraction force cannot be neutralized by placing uncharged or non-magnetic matter between the Earth and another object. If this were done, such matter would simply participate in the same “unequaling effect” between its own “negative-positive” (gyro-

scopic-action-particle) composition on Earth.

²⁹
F. One may ask, “When they are both dropped from the same height, why doesn’t a heavy mass fall faster than a light mass towards a significantly larger mass, e.g., the Earth?”

ANSWER: Such masses fall at the same rate because the attraction force (due to the “unequaling effect” [Gravity]) will be only a small percentage of the “unity force of 1” (in effect between all gyroscopic-action-particles comprising all Matter) and will also be a constant for a particularly large mass such as the Earth. (See Figure 29-F.)

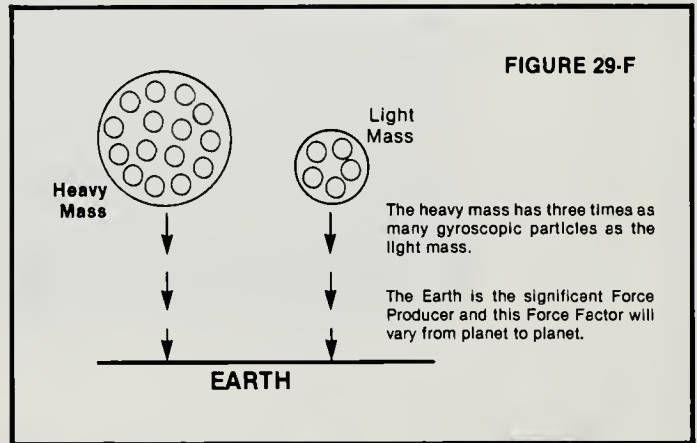

²⁹
G. The (attraction) “Force Factor” (with a magnitude on the order of .0001 of the “unity of 1” occurring between all “oppositely-charged” gyroscopic-action-particles) demonstrates that the speed of an object (as a result of that “Force Factor”) is independent of the number of gyroscopic-action-particles comprising that object. This is true because every gyroscopic-action-entity comprising that object has the same small attraction “Force Factor” with respect to the Earth. As a result, the object cannot travel any faster (than the independent speed of its basic composition) towards the major “Force Producer,” e.g., the Earth.

EXAMPLE: Observe the following simple analogy:

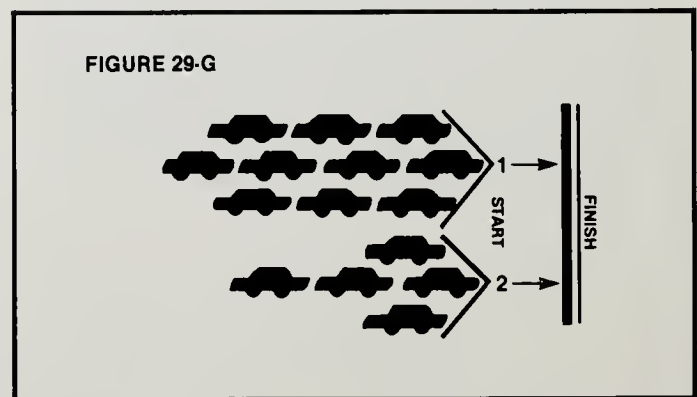

In Figure 29-G, there are two auto drag strips labeled 1 and 2. On drag strip 1, there are ten identical automobiles which can each achieve a speed of 100

mph in ¼ mile. On drag strip 2, there are five automobiles identical to those on drag strip 1, and each automobile can achieve a speed of 100 mph in ¼ mile. If all the automobiles on drag strips 1 and 2 start at the same instant, the front automobile in the 10-car group will reach the finish line at the same instant as the front automobile in the 5-car group.

However, if one attempted to stop both groups at the finish line, one would need to exert *twice* the force to stop the 10-car group as the 5-car group. (If the automobiles had twice the motor power, then they would travel twice as fast.) This simple analogy represents the same effect gravity has upon mass via the Unobvious effects of "unequal effects" between gyroscopic-entities comprising all Matter.

²⁹**H.** The difference in the Gravity Effect of various planets occurs for the same reason that — like the two groups of automobiles — such planets have different masses. (See Figure 29-H1 and 29-H2.)

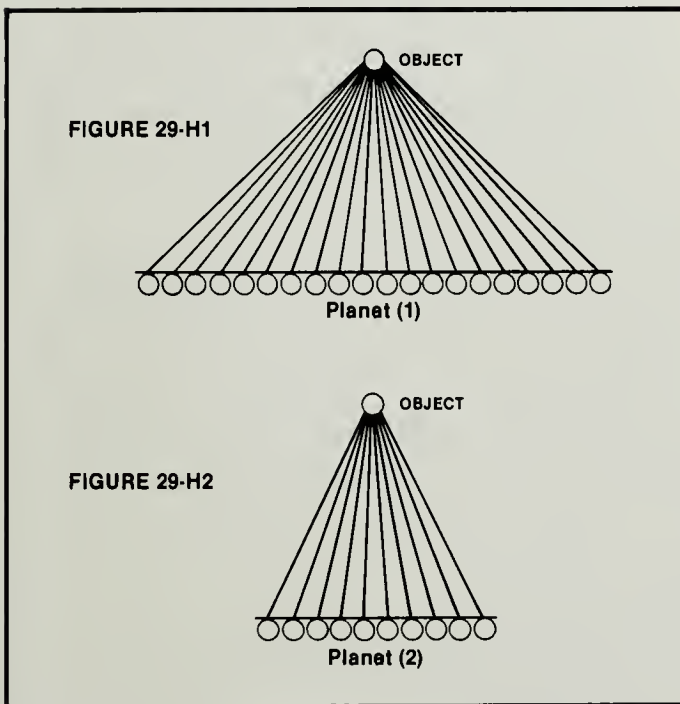

If Planet 1 has twice the gravitational force of Planet 2, then Planet 1 is twice a "major force producer" than Planet 2. Falling objects on Planet 1 would equally respond in accordance with the "major-force-producer effect" (Gravity) of Planet 1. The same objects placed on Planet 2 would equally respond in accordance with the "major-force-producer effect" (Gravity) of Planet 2. However, the gravitational effect of Planet 2 would be *half* that of Planet 1.

²⁹**I.** Prior to my work, Matter has been thought to be equally composed of "negative" and "positive" charges. The Facts I have presented demonstrate that this is not true and that Matter is composed of immeasurable numbers of "negative" and "positive" gyroscopic-action-particles. Moreover, the possible com-

binations (of such particles) are infinite, allowing Matter to vary in gyroscopic particle composition which can be predominately "negative" (gyroscopic particles) or "positive" (gyroscopic particles). As proof of these variances in "positive" and "negative" charges within Matter, see Figure 29-I:

ELECTROMOTIVE SERIES OF THE METALS

Metal	Electrode Potential ("Volts")
Lithium	- 3.02
Potassium	- 2.92
Barium	- 2.90
Sodium	- 2.71
Aluminum	- 1.67
Zinc	- 0.76
Chromium	- 0.71
Iron	- 0.44
Nickel	- 0.25
Tin	- 0.14
Lead	- 0.13
Hydrogen (arbitrarily set at zero volts reference)	0.00
Bismuth	+ 0.20
Copper	+ 0.34
Silver	+ 0.80
Mercury	+ 0.85
Gold	+ 1.68

(Conventional teachings depict these differences on an inefficient chemical basis. I teach these differences also exist on a more significant and powerful $E = MC^2$ basis.)

It is obvious that such variance in electrode potential can only occur as a result of different electromagnetic composition between the various substances. If all Matter was simply composed of an equal number of "negative" and "positive" gyroscopic particles, then such electrode potential differences could not exist. (Because such differences are so slight compared to the immense quantity of "negative" and "positive" gyroscopic particles, the differences are not Obvious in normal utilization of the substances.)

²⁹**J.** Another Proof of such variance in quantity of "negative" and "positive" gyroscopic particles can be observed by the conventional facts of present teachings:

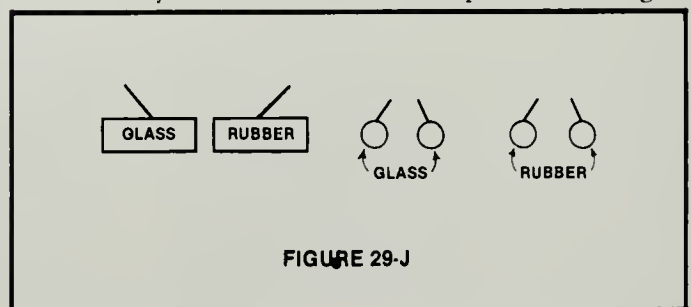

In observing Figure 29-J, it has been said that: "Rubber rods and glass rods can be made to have an electric charge by rubbing the rubber with fur or flan-

nel and the glass with silk. Two electrified pieces of hard rubber rods will be found to repel each other as will two electrified glass rods; but an electrified hard rubber rod will attract to an electrified glass rod."

The experiments depicted in Figure 29-J do *not* prove that different materials are composed of equal numbers of "negative" and "positive" charges (gyroscopic particles), but proves just the opposite. If the materials were *equal* in their "negative" and "positive" composition, then one would obtain equal results when the glass or rubber rods were rubbed; moreover, one would also obtain equal results when both glass or rubber were rubbed with silk or fur.

²⁹
K. It is a known Fact that electrical charges (gyroscopic particles) will tend to place themselves as far from one another as possible, or they will distribute themselves in such a manner that their density per surface unit is everywhere equal.

Let's examine what occurs when my teachings are applied to these observed results:

I teach that when one rubs the glass and rubber rods together (both are good electrical insulators) as in Figure 29-J, the "outer skin" surface of the material either loses or gains gyroscopic particles (electrical charge) demonstrating the "negative" and "positive" composition of all Matter. [Remember, all gyroscopic particles are identical. Those that are "negative" would — to an outside observer — appear to spin in a different direction from those that are "positive." But such "negative" and "positive" gyroscopic particles are rotated 180° with respect to one another.]

In Figures K-1 and K-2, the gyroscopic-action-particle spin on the glass rod is *opposite* to that on the rubber rod. One can see that the periphery interaction of the gyroscopic particles (spinning at the speed of light) on edge K-1(b) would easily "merge" (attract) with those periphery spins of the gyroscopic particles on edge K-2(a). [The same is true for edges K-2(b) and K-3(a).]

Attraction would *also* occur if the glass rods were placed parallel to the rubber rods. However, by studying the above Figures, one should also observe how the edges of the two glass rods (or two rubber rods) placed end-to-end or side-to-side would *repel* one another, e.g., edge K-3(b) placed against edge K-4(a). Such repulsion occurs because the periphery spins of the gyroscopic particles on edges K-3(b) and K-4(a) are in the *same* direction. [The periphery attraction/repulsion of the gyroscopic particles occurs in the same manner as the periphery attraction/repulsion discussion in the Section on Magnetism (See Chapter Three).]

In Figures K-5, K-6 and K-7, it should be apparent that the three rubber rods would repel one another since all their gyroscopic particles are spinning in the *same* direction causing all edges (and their respective gyroscopic particle peripheries) to repel one another.

²⁹
L. QUESTION: What would occur if the rubber rod in Figure K-2 was flipped over 180°?

WRONG ANSWER: The rubber rod in Figure K-2 would now be repelled to the glass rods in above Figures K-1 and K-3 as the gyroscopic particles of the rubber rod would now be flipped over 180° to repel the glass rods as shown in Figures L-1, L-2 and L-3 as depicted on the following page.

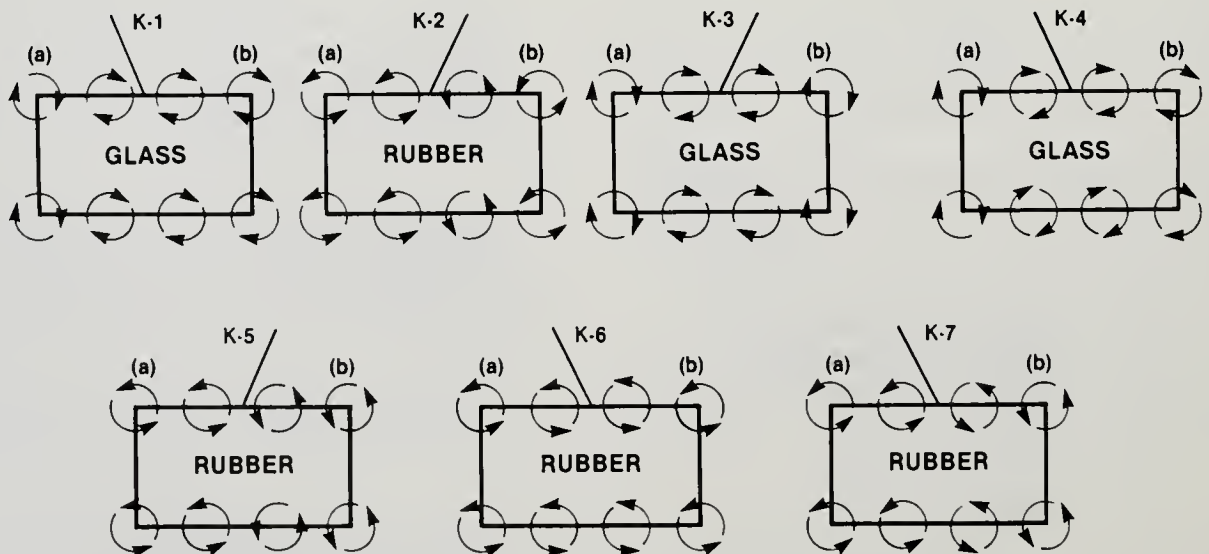

FIGURES 29-K-1 through 29-K-7

FIGURES 29-L-1 through 29-L-3

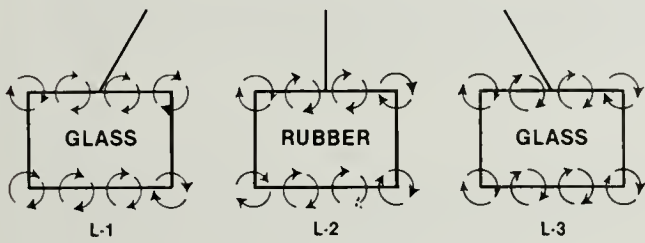

"This is the **incorrect** answer!"

RIGHT ANSWER: It makes no difference if you flip over by 180° the rubber rod in Figure K-2. Regardless of how one flips or turns rubber rod K-2, one would *still* see the *same* spin direction for the gyrosopic particle (electrical charge) comprising rubber rod K-2. There would still be an attraction force between the glass and rubber rods regardless of their respective orientations. (See Figures L-4, L-5 and L-6.)

FIGURES 29-L-4 through 29-L-6

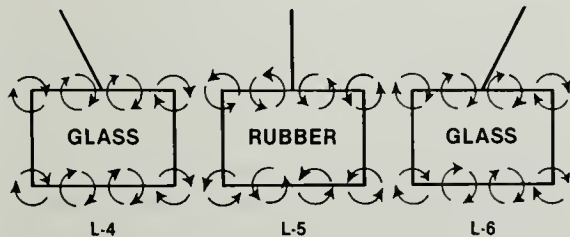

"This is the **correct** answer!"

²⁹
M. Once again I state my "humbling" feeling concerning the simple nature of this gyrosopic particle:

"I SIT IN AWE UPON THE REALIZATION OF THIS INGENIOUS MECHANISM THAT IS SO SIMPLE THAT IT BEFUDDLES THE MIND."

Magnetic and Electric Fields are indeed equal. **They are one and the same!**

The basic mechanism of nature is ingenious because all Matter is composed of one type of Gyrosopic-Action-Particle. By traveling in varying directions, such particles create a force influence upon one another causing them to gyrate with respect to one another. As a result, this mechanical action and vary-

ing numbers of gyrosopic particles then create infinite types of Matter. The mathematical combinations (of such possible gyrations combined with the number of gyrosopic particles) are infinite.

Such a view is consistent with all Matter in the Universe being composed of the same entity having an attraction (or repulsion) of "ONE" towards another. This mechanically explains the consistency between the mathematical laws of Magnetism, Electric Charge, and Gravity. My comprehension of this mechanism generates in me a most "humbling" experience, which I feel even to this day. I hope you, the reader, also experience this feeling.

I will now present additional Facts for your consideration and study.

Chapter 17

INERTIA

"Why should gravitation, of all the many forces in nature, be the only one to be so intimately related to inertia, which is supposed to be an inherent property of bodies that is independent of the nature of the force being exerted?"

— Peter J. Brancazio

I will begin the subject of inertia with a quotation* from the exceptionally well-written book entitled *The Nature of Physics* by Peter J. Brancazio.

30. A. Quoting from pages 146 and 147:

INERTIA AND GRAVITATION

"One aspect of gravitation that may provide a clue as to its ultimate nature is the peculiar relationship between gravitation and inertia. This relationship is most pointedly illustrated when we re-examine in detail the derivation from Newtonian principles of the law of falling bodies. Newton derived the law by substituting the gravitational force between the earth and a falling body of mass m into the equation $F = ma$:

$$F_{\text{grav}} = \frac{GM_E m}{R_E^2} = ma$$

"The next step is to cancel the m on both sides of the equation, with the result that the acceleration $a = GM_E/R_E^2$ is independent of the mass of the falling body. Herein lies the mystery.

"The m that appears in the equation $F = ma$ is a measure of the *inertia* of the body. It measures the resistance of a body to *any* force. Let us call this the **inertial mass**. The m that appears in the equation $F = GMm/d^2$ determines the strength of a *particular* interaction involving the body — namely, the gravitational force. Let us call this the **gravitational mass**. The inertial and gravitational masses must be exactly equal; otherwise we could not cancel them in the above equation. If they *did not* cancel, we would arrive at the conclusion that the acceleration of a falling body *does* depend on its mass (either inertial or gravitational, or both), which is contrary to experience. The theory of gravitation would be incorrect.

"Therefore, we see that Newton did not really derive the law of falling bodies; rather, the law of falling bodies (an experimental result) *forced him to assume that the inertial and gravitational masses must be equal*.

"The equality of the inertial and gravitational masses is extremely puzzling to physicists. Why should gravitation, of all the many forces in nature, be the only one to be so intimately related to inertia, which is supposed to be an inherent property of bodies that is independent of the nature of the force being exerted? This connection between inertia and gravity — two completely different and otherwise unrelated properties of bodies — has thus far eluded an explanation. In fact, Einstein looked on the equality of inertial and gravitational mass as a fundamental principle of nature and used it as a starting point for the general theory of relativity. This theory provided yet another conceptualization of gravity. Einstein's theory of gravitation is far too complex to summarize in a few sentences, so we will defer a discussion of it until a later chapter. In any case, the equality of the inertial and gravitational masses is clearly an important clue as to the fundamental nature of gravitation (and inertia as well). This equality must be explained by future physicists if a deeper comprehension of gravitation and inertia is to be achieved.

"In view of the lack of a fundamental understanding of the nature of gravity, it seems remarkable that Newton's theory of gravitation could have brought about such an enormous advance in our understanding of the universe. But this is characteristic of the way in which science progresses. It is not necessary to understand gravity fully in order to have a successful theory of gravitation. Simply by accepting the concept of gravitation as an axiom, we can account for a wide variety of seemingly unrelated phenomena in relatively simple terms. Thus in view of its simplicity, comprehensiveness, and predictive power, the theory of gravitation must be considered an outstanding theory. The attempts on the part of some physicists to 'understand' gravity represent the next state in man's attempt to probe ever more deeply until the ultimate answers are found — if, in fact, such answers exist."

[*Reprinted with permission of MacMillan Publishing Company from *The Nature of Physics* by Peter J. Brancazio, Copyright © 1975 by Peter J. Brancazio.]

30

B. I have already demonstrated that Gravity represents the "Unequalizing Effect" of the number of "negative" and "positive" gyroscopic particles comprising all Matter. [Again I stress that such "negative" and "positive" gyroscopic particles are in reality *one* type of gyroscopic particle which is depicted as "negative" or "positive" depending upon the particle's given spin direction and the specific plane of that spin direction.]

The *dominating mechanical essence* of the observations concerning the term "Gravity" of a planet (large bodies in space) upon other objects represents the Obvious "force factor effect." Such an effect is sometimes Unobvious. The mechanical effect of the term "weight" of an object is totally relative to the number of gyroscopic particles comprising that object, the Unequaling Effect of its electrical charges, and the Unobvious "force field effect" of a particular gravitational field! Such a description is the same for gravity, except that gravity can be observed as either "Unobvious" or "Obvious."

30

C. I will now demonstrate that the "Inertia" of a mass is also mechanically related to the quantity of gyroscopic-action-particles comprising that mass. Inertia is simply the Unobvious, mechanical effects of the "speed" of the gyroscopic action of the basic building entity of all matter: *the Gyroscopic Particle!*

Consequently, one can easily mechanically understand why inertia and gravitational masses are equal. They *both* represent one and the same gyroscopic-action-entity (see Section 30-A) which demonstrates the mathematical "oneness" of the two effects.

The following quote is a tribute to Michael Faraday:

"Faraday, in his last years, tried to show experimentally a relation between gravity and electricity, concluding his paper with, 'Here end my trials for the present. The results are negative; they do not shake my strong feeling of the existence of a relation between gravity and electricity, though they give no proof that it exists.'"

30

D. To understand the relation between gravitation and inertia, one must first have the proper mental perspective. The effect of inertia is extremely small. Therefore, the mechanical essence of inertia can be very deceptive.

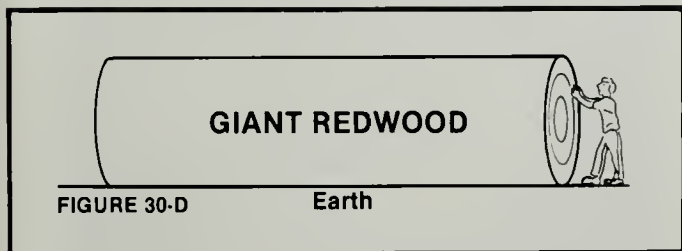

the "gravity effect." (This effect was originally explained in Section 29-H.)

30

E. Have the same massive log suspended by a cable and attached to a support which permits the massive log to balance in the air. (See Figure 30-E.)

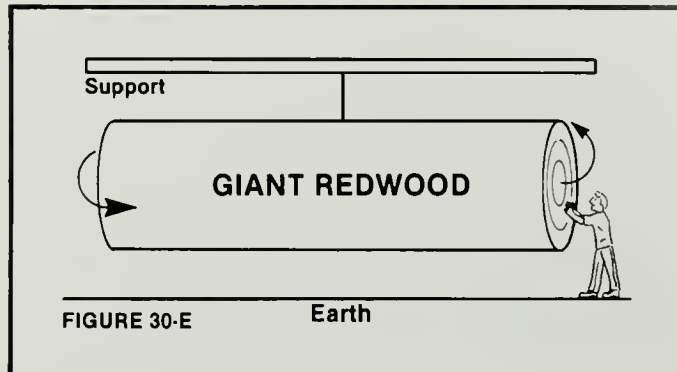

In this example, one has mechanically produced an "Unobvious Force" which does *not* in any way cancel the "gravity effect," but has simply "counter-equaled" the "gravity effect" with respect to the massive log. In Figure 30-E, one will now find it relatively easy to move the massive log parallel to the Earth's surface, e.g., swinging end 2 around 180°

30

F. One can easily see that Figure 30-E demonstrates two points:

(1) Even when the "gravity effect" was counter-equaled, there remained some type of resistance (Unobvious) force to the movement of that mass. This resistance (Unobvious) force is called "inertia."

(2) The Facts show that such "inertia" — as a resistive (Unobvious) force — is *extremely weak* compared to electric or magnetic forces which have a "unity factor of 1."

30

G. One can conclude that this weak, "inertia-mass effect" is only some percentage of the "unity factor of 1" and similar to the weak "gravity-mass effect."

CONSIDER THE FOLLOWING: Einstein's General Theory of Relativity has been criticized for its failure to explain the concept of inertia. In Newtonian mechanics, it is stated as a fundamental principle that bodies possess inertia, but it is not explained why bodies possess this property.

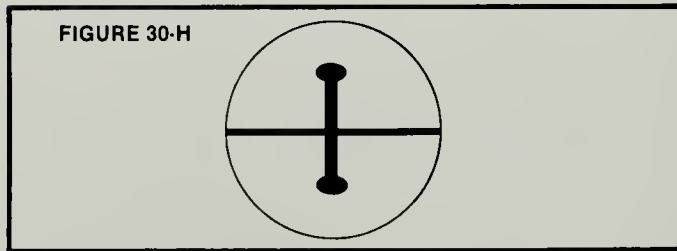

30

H. Consider the following experiment: a two-foot diameter, fiberglass ball has a 10-pound, one-foot diameter gyroscope hidden inside (see Figure 30-H)

Imagine a massive log lying on the Earth's surface. As one attempts to lift even the log's end (see Figure 30-D), one would encounter great resistance due to

which has been rotated to 30,000 RPM (perfectly balanced). An uneducated man walks up to the ball and starts rolling it. As long as he rolls the ball in a direction that does *not* change the plane of axis of the internal gyroscope, the ball will roll relatively easily. However, when he tries to roll the ball in a direction which applies a force which attempts to tilt the axis of the internal gyroscope, the uneducated man would be dumbfounded since the ball would then resist him with great force. The ball would start gyrating in a rotational motion at right angles to the direction he pushed the ball. The ball would greatly resist his efforts to accelerate or reverse that rotational gyration. If, at a later time, someone informed him about the inertia of an object, he would comment, "I know of an object that has a 'varying inertia.'" In essence, *the mechanical cause for the difference in observed results is caused by the "speed" of the internal mass!*

³⁰
I. Because matter is principally equal in its "negative" and "positive" mechanical composition, *i.e.*, it consists of the same, gyroscopic-action-entity spinning in opposite directions, one may at first be deceived and conclude the following:

WRONG CONCLUSION: Matter is principally "negative" and "positive" in its composition and therefore there would be a "cancellation effect" with respect to a pivoting motion when an (Obvious) force tilted their respective axes. Therefore, the gyroscopic-action-entity cannot be the cause of the "inertia effect."

³⁰
J. Let's examine the CORRECT CONCLUSION:
 Consider the fact that (Obvious) Force = Inertia Mass X Acceleration. "The *m* that appears in the equation $F = ma$ is a measure of the inertia of the body." (See Section 30-A.) Therefore, in reality, the inertia ef-

fect is relative to the "speed" of the mass. If the mass has no speed then it can have no acceleration. During acceleration the mass simply has *varying* speeds.

Hence, one can conclude from the facts that any mass having speed also has inertia.

³⁰
K. If one simultaneously shoots a bullet and drops another bullet (of equal mass to the first bullet) from the same position, they will both collide with the Earth's surface at the same instant. (See Figure 30-K.) WRONG CONCLUSION: Because the gravity effect (Obvious Force) caused the two bullets with equal masses to simultaneously collide with the Earth's surface, it can be concluded that the inertia effect of the two bullet-masses did not change at any time.

³⁰
L. Consider the following experiment which will demonstrate why the above conclusion is wrong:

Construct a configuration as depicted in below in Figure 30-L. Place two bullet "traps" equidistant from the end of the gun barrel. With the assistance of an electric eye (which can react fast enough) and an appropriate mechanical device, the two traveling bullets would be simultaneously deflected at a right angle to their respective trajectories into traps 3 or 4. In addition, a pressure gauge could be connected to the mechanical device employed to deflect the bullets into the two traps. The purpose of the gauge is to measure the exact (Obvious) "opposing" force required to deflect the two bullets of equal masses into the two traps.

It should be obvious that to deflect the two bullets will require considerably more (Obvious) force with respect to the mass of trap mechanism 3 than for the mass of trap mechanism 4.

QUESTION: Why the difference in force?

FIGURE 30-K

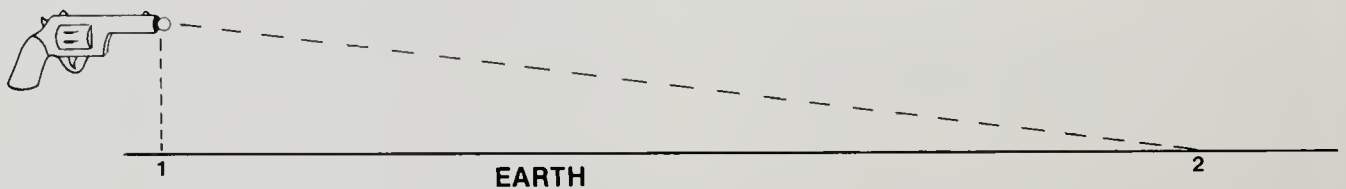

FIGURE 30-L



ANSWER: The difference in the forces demonstrated by the two trap masses is a result of the additional speed added to the composition of their masses. This additional speed is also added to the "natural" speed of the basic building entity of each mass: the gyroscopic-action-particle.

Because the mass of trap 3 had greater speed added to its mass than the mass of trap 4, the test instruments would indicate that the mass of trap 3 has a greater inertia effect than the mass of trap 4.

ADDITIONAL PROOF: When the additional speed is removed (*i.e.*, the mass is stopped), then the two bullet-masses demonstrate equal inertia effects.

³⁰
M. Consider the fact that motion (energy) is the "natural" state of the Universe, and that the absence of motion (lack of speed) of Obvious Mass is the "unnatural" state of the Universe.

Energy's motion (speed) is always present, even when such energy — in the form of gyroscopic particles moving at the speed of light and spinning at the speed of light — is combined to form an Obvious mass which macroscopically has an apparent absence of motion. However, an observer who was microscopically placed "inside" that Obvious mass would observe the basic energy of all matter — the gyroscopic-action-particle — moving at very high speeds!

The natural, inertia effect of an Obvious mass is the result of the "speed" of the gyroscopic-action-particle which is the basic building entity of all mass.

The "negative" and "positive" charge composition of matter does *not* cancel the speed of the infinitely small, gyroscopic particle masses. Such charges only produce an equaling "counter force" which prevents an (Obvious) mass from behaving as a single, conventional gyroscope. Moreover, the speeds of those infinitely small masses still exist and the existence of such speeds is proven via the observed, inertia effect of an (Obvious) mass.

³⁰
N. To further sensitize the reader to the fact that one cannot take the ingenious action of the gyroscopic-particle-composition of matter for granted, conduct the following test: (GYROSCOPIC PLANES shown below.)

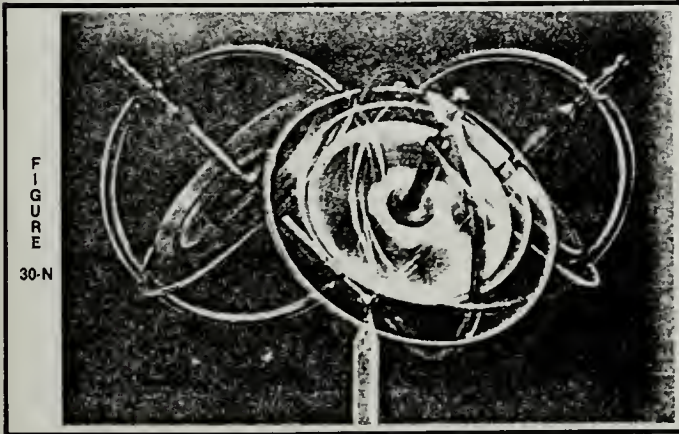

FIGURE
30-N

Spin a small, toy gyroscope and then balance it on the end of a rounded pencil point. (See Figure 30-N.) If one lightly holds the pencil at its base, the top end of the pencil will proceed to pivot in all lateral directions at a rapid pace. Under such conditions, one would feel a continuously changing force which is parallel to the Earth's surface.

Before conducting the test, one would tend to assume that when a gyroscope was moved *parallel* to the Earth's surface, one would experience no resistance in spite of the speed of the gyroscope's spinning mass.

"The natural, inertia effect of an Obvious mass is a result of the 'speed' of the gyroscopic-action-particle which is the basic building entity of all mass."

³⁰
O. Mass consists of gyroscopic particles spinning at the speed of light and moving at the speed of light. With such rapid motion, a "solid" mass would appear to indicate to the outside observer that the internal gyroscopic particles of the mass are rigidly secured.

However, such gyroscopic particles are not rigidly secured, but are actually internally suspended in space within the mass comprised of such gyroscopic particles. In addition, the gyroscopic particles appear to align the spin of their infinitely small masses to certain "planes of spin."

FIGURE 30-O

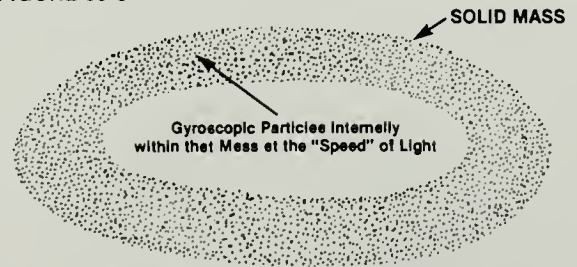

The speed and orientation of the infinite number of gyroscopic particles are obviously not to be taken for granted!

Figure 30-O depicts a "solid" mass consisting of an incredible number of gyroscopic particles electromagnetically coupled and suspended within the space of this (Obvious) mass.

³⁰
P. An Obvious Force exerted upon a mass or "spinning" mass does not create the inertia effect. It is the *resistance* to that Obvious Force which is perceived as the inertia effect.

EXAMPLE: If one tilts the plane of a spinning mass (gyroscope) to an angle equal to the gyroscope's original plane of orientation in space, one will experience a *right-angle resistance*. The greater the

angle of displacement of that gyroscopic plane in a given instant of time, then the greater the resistance. (See Figure 30-P.)

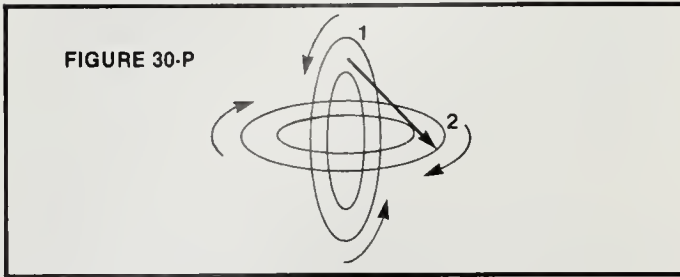

If one pivots the gyroscopic plane of spin from point 1 to point 2, one will observe a noticeable resistance. Such resistance could be called an "inertia effect." If one then *stops* the gyroscopic spin and repeats the same motion from point 1 to point 2, then one will notice very little resistance.

QUESTION: Why the difference in resistance?

ANSWER: Such a difference is a result of the speed of the mass, *i.e.*, the additional speed added to the speed of the gyroscopic spin comprising the mass.

³⁰
Q. If the results of the test in Figure 30-P are puzzling, repeat the same test but envision the internal motion of the particles comprising the "solid" mass. (See Figure 30-Q.)

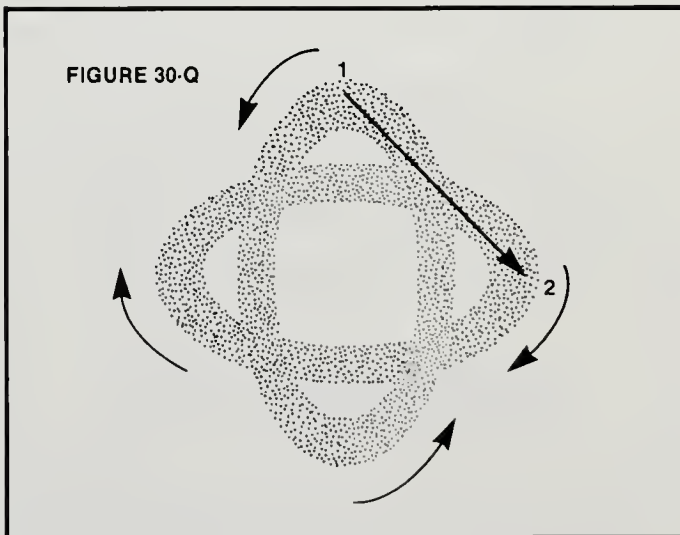

In Figure 30-Q, since the gyroscopic particles travel in opposite directions when the mass is rotated in opposite directions, one can easily understand why the spin direction causes opposite results in terms of

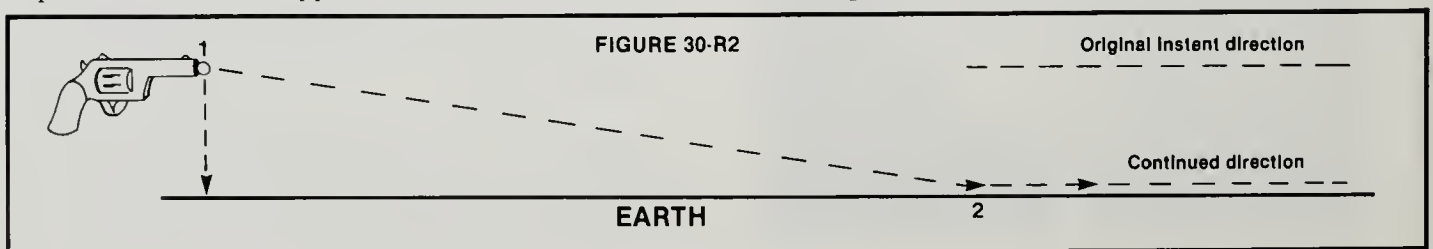

whether the spinning mass pivots left or right in response to an Obvious Force. In Figure 30-Q, one should see a similarity between the force required to pivot the mass (composed of gyroscopic particles) from point 1 to point 2 and the force required to deflect a bullet from its initial direction into a trap. (Refer to Figure 30-L.)

In tests 30-L and 30-Q, the gyroscopic particles comprising the masses involved have been forced to pivot at right angles to their previous plane-in-space direction. *The resistance incurred is a direct result of the speed of the particles involved. When the speed of the (Obvious) mass was removed, e.g., when the mass was stopped, then the inertial effect was reduced.*

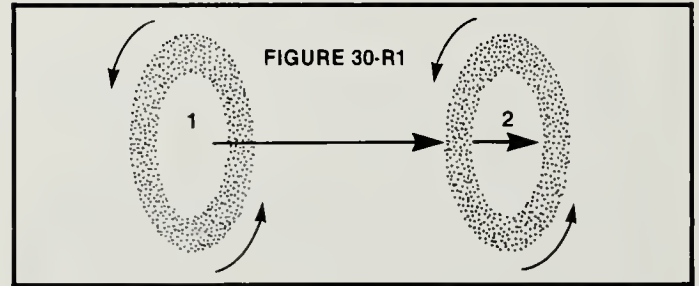

³⁰
R. Envision a gyroscopic (Obvious) mass as in Figure 30-R1, which moves the plane of the spinning mass from point 1 to point 2 in a *parallel* position to the original plane of gyroscopic spin in space. [Remember, mass consists of infinitely small gyroscopic particles spinning at the speed of light and moving at the speed of light.]

In Figure 30-R1, one will observe noticeably less resistance in moving the mass from point 1 to point 2 compared to the resistance which is encountered in Figure 30-Q.

QUESTION: Why the difference?

ANSWER: There is an extreme mechanical difference between Figure 30-Q and Figure 30-R1. This difference is a result of the fact that the particles comprising the spinning mass in Figure 30-R1 have had their plane of spin moved parallel to their original plane in space.

The mechanical difference is similar to the test in Figure 30-K in which the bullet mass was permitted to collide with the ground. If the bullet had continued traveling in a straight line following impact with the Earth's surface, the bullet mass would have traveled in a direction parallel to its original instant direction. (See Figure 20-R2.)

S. Pay close attention to the test results in Figure 30-R2: one can be deceived into believing that the inertia effect of the bullet masses did not change because the Obvious Force of gravity caused both bullet masses to collide with the Earth at the same instant. From the test in Figure 30-L, it has been demonstrated that there *is* a difference in inertias, but that the difference is deceptive. The same difference is true for the test in Figure 30-R1. I have no doubt that if one could accelerate the *speed* of the rotating mass (in Figure 30-R1) to that of light, one would find a greater resistance than at conventionally slow speeds of only thousands of revolutions per minute.

REASON FOR SUCH GREATER RESISTANCE: The particles comprising that mass have a fixed plane or position in space, e.g., a circular motion as in Figure 30-S1.

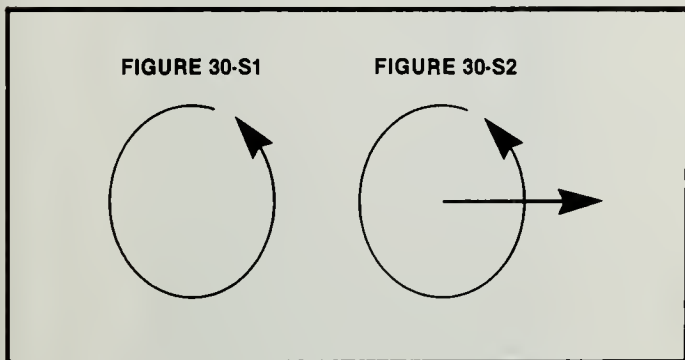

In Figure 30-S1, one imposes a lateral direction upon a particle traveling in a *rotational* plane direction. The energy necessary to impose this directional change must be imposed from an external source. If one wishes to accelerate the speed of the lateral direc-

“The gravity, inertia, and weight effects will all decrease or increase as gyroscopic particles (comprising all Matter) are physically removed or added to the mass in accordance with Einstein’s equation of $E = MC^2$ ”

tion, one must impose additional energy to overcome the previously compounded motion (speed) of the particle in space.

T. It should be obvious from the above Facts that, like the gravity effect, the inertia effect is very deceptive. Both effects are a result of the gyroscopic particle composition of all matter.

The gravity, inertia, and weight effects will all decrease or increase as gyroscopic particles (comprising all matter) are physically removed or added to the mass in accordance with Einstein’s equation of $E = MC^2$. In addition, the gravity, inertia, and weight effects represent only a small percentage of the “unity factor of 1” (discussed in Sections 29-C and 29-D) characteristic of all gyroscopic particles comprising all

matter. As mathematics would predict, all three effects represent the actions of one mechanical entity — *the gyroscopic particle*.

The following statement by Albert Einstein verifies my mechanical teachings:

“If a body gives off the energy E in the form of radiation, its mass diminishes by $E/c \pm \dots$. The mass of a body is a measure of its energy-content; if the energy changes by E , the mass changes in the same sense by $E/c \pm \dots$. If the theory corresponds to the facts, radiation conveys inertia between the emitting and absorbing bodies.”

The previous quotation in Section 30-A concerning Newton’s mathematics further verifies my mechanical teachings. The interrelated “oneness” of all the various Facts I have presented is more important than any Fact by itself.

Chapter 18

HEAT AND THE THREE LAWS OF THERMODYNAMICS

"... I have built my house on the foundation of your theory of Latent heat and ... I owe a just way of thinking on these subjects to you."

— from a letter by James Watt to Joseph Black, December 13, 1782

I wish to pay tribute to Joseph Black (1728-1799), Scottish chemist and physicist, who is one of the greatest scientists who ever lived. I have no doubt in my mind that had I visited Joseph Black in the 1760's and had I informed him that $E = MC^2$, he would have replied: "I believe what you have stated is very possible since my years of research have indicated to me that some immense energy *does exist* in mass or matter." With Joseph Black's brilliant work and great insight, he would have had no difficulty or hesitation in accepting the validity of $E = MC^2$.

It is appropriate first to discuss chemistry and heat as a prelude to analyzing the Three Laws of Thermodynamics.

³¹
A. Chemistry is the study of the composition of all forms of matter found in the Universe. I will demonstrate that chemistry is consistent with my single teachings concerning the nature of electromagnetic energy:

In chemistry it is presently stated that every bonding between atom and atom, as well as between molecule and molecule, represents potential energy sources.

I now introduce the fact that *all* chemical reactions always involve electromagnetic energy. It makes no difference whether the reactions are endothermic [when the reaction *absorbs* heat, light, or electrical energy (all forms of electromagnetic energy)] or exothermic [when the reaction *releases* heat, light or electrical energy]. Scientific conclusion: all chemical reactions are the result of absorbing or releasing electromagnetic energy. Furthermore, electromagnetic energy in the form of the previously described gyroscopic particles comprises all matter.

³¹
B. It is appropriate to analyze a serious mistake once made in science: I return to the debate concerning whether heat was a transferable entity called Caloric, or whether heat was simply the result of motion as stated by the critics of the Caloric Theory. The motion concept of heat is still believed today in science and such a concept led to the Kinetic Theory.

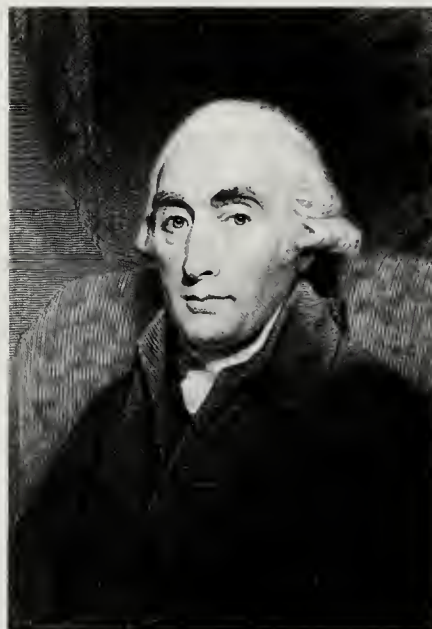

Joseph Black

Courtesy of Edgar Fabs Smith Collection,
University of Pennsylvania

About 1770, Joseph Black made some brilliant discoveries concerning heat. Black showed that heat represented a quantity of something and that temperature was the degree of hotness. In effect, he had discovered that heat and temperature were not the same. Not one of Joseph Black's contemporaries had been able to establish a sharp distinction between heat and temperature.

To the great surprise of Joseph Black's colleagues, and even to us today, Black demonstrated that water continues to increase in temperature until it comes to a boil and then the temperature rise will stop and remain the same until all the water is boiled away. Such a constant temperature is observed *even if extreme heat is employed. Moreover, the reverse is true when the vapor or steam condenses.*

Joseph Black also established that a mixture of ice and water remains at the same temperature — although heat may be emitted or absorbed — until it is transformed entirely into ice or water. Black used the term "latent heat" to describe the process of heat absorption.

Black wrote: "My conjecture, when put into form, was to this purpose, I imagined that, during boiling, heat is absorbed by the water, and enters into the composition of the vapor produced from it, in the same manner as it is absorbed by ice in melting, and enters into the composition of the produced water."

It is quite apparent to me that Joseph Black's curiosity and powers of reasoning were extremely high, considering the limited scientific knowledge available during his time. Black understood what others — even today — have not understood. Without any doubt in his mind, Joseph Black knew that heat was absorbed and emitted by Matter and that heat was some type of entity that composed all Mat-

"With Joseph Black's brilliant work and great insight, he would have had no difficulty or hesitation in accepting the validity of $E = MC^2$."

ter. He simply did not know what this entity is: *gyroscopic, electromagnetic energy!* The Facts clearly show that all Matter is changed in its mechanical characteristics as it absorbs or emits heat, *i.e.*, a *random* flow of gyroscopic-action-particles.

Following Black's discoveries, this basic idea was so refined and developed that it conveniently accounted for all heat phenomena observed at the time. To explain all heat phenomena, scientists turned to the old concept which was later known as the Caloric Theory.

The following are the essential postulates of the Caloric Theory as established in 1779:

- (1) Caloric is an elastic fluid whose particles repel one another.
- (2) Caloric particles are strongly attracted by the particles of other Matter, and different kinds of Matter attract caloric with different strength.
- (3) Caloric is indestructible and uncreatable.
- (4) Caloric can be either "sensible" or "latent," *i.e.*, either felt or stored. Latent heat is "chemically" combined with particles of Matter to change a solid into a liquid or a liquid into a vapor.
- (5) Caloric does not have weight. [Of course, heat does have weight according to $E = MC^2$.]

The theory offered in opposition to the Caloric Theory was never so direct and this opposition theory required a long time to evolve. As early as 1620, Sir Francis Bacon had said, "Heat itself, its essence and quiddity, is motion and nothing else." This line of thought was endorsed by many other scientists following Bacon's time.

At this point it is important to indicate a scientific fact: during the time this Caloric-Kinetic argument was undergoing intense debate, there was absolutely no scientific acceptance that there was even a connec-

tion between electricity and magnetism! It is important to remember that heat is "gyroscopic" electromagnetic energy! *Question:* If one does not understand that there is even a connection between electricity and magnetism, how can one really understand heat, which is "gyroscopic" electromagnetic energy?

In 1788, Count Rumford (also known as Benjamin Thompson, British physicist, 1753-1814) rejected the Caloric Theory of heat on the basis that heat was a form of motion. He accepted this "motion effect" as a result of observing the boring of a cannon barrel. He concluded that friction could generate an *inexhaustible supply of heat*. *Question:* Did he have any conception of $E = MC^2$? *Answer:* No! The only point Rumford proved with this cannon-boring experiment is that $E = MC^2$.

Keep the cannon-boring experiment in mind, because in a few pages I will demonstrate that *heat release is a result of the compression of atomic entities which comprise all matter*. For those who are not familiar with metal cutting on a lathe, high pressure is used to push the cutting tool into the metal being cut. Such high pressure is a result of the mechanical power of the screw.

In 1799, Sir Humphry Davy (English chemist, 1778-1829) caused two pieces of ice to melt by rubbing them together while in freezing conditions. He claimed that the result of this particular ice experiment constituted a failure of the Caloric Theory since the experiment proved that the resulting heat was simply caused by motion.

However, Davy's statement is not true! If the heat was simply the result of motion, then the two pieces of ice would have melted just as quickly by moving them separately while in the freezing temperature. Anyone knows that this simply isn't true. I will show that heat release is the result of mechanical compression. [Remember that it wasn't until 1820 that the Danish physicist Oersted discovered a connection between electricity and magnetism. Heat, electricity, and magnetism are *all* electromagnetic energy.]

"... heat release is a result of the compression of atomic entities which comprise all Matter."

Let's examine several facts: Molecules consist of atoms. Atoms consist of smaller entities. *Question:* What comprises the smaller entities? Remember, from the beginning of this Book, I have hypothesized that atoms and all Matter consist of electromagnetic energy, *i.e.*, gyroscopic-type-particles.

The scientific hypothesis concerning the interior structure of the atom has changed continuously over the years. Over thirty fundamental atomic particles have been released from the nucleus of an atom. The more that is known, the more the mystery deepens. Presently, physicists are no longer even certain that

protons, neutrons, and electrons do, in fact, occupy space. Some hypotheses describe these particles as waves or “points without volume” — mathematical singularities *haunting* space.

Based upon the present scientific understanding of Matter, this same description would apply to the energy in the force fields of a magnet. However, I have already shown that such force fields are all electromagnetic energy and possess gyroscopic, mechanical-like characteristics which can be explained and predicted. Such characteristics are also true for heat absorption and release:

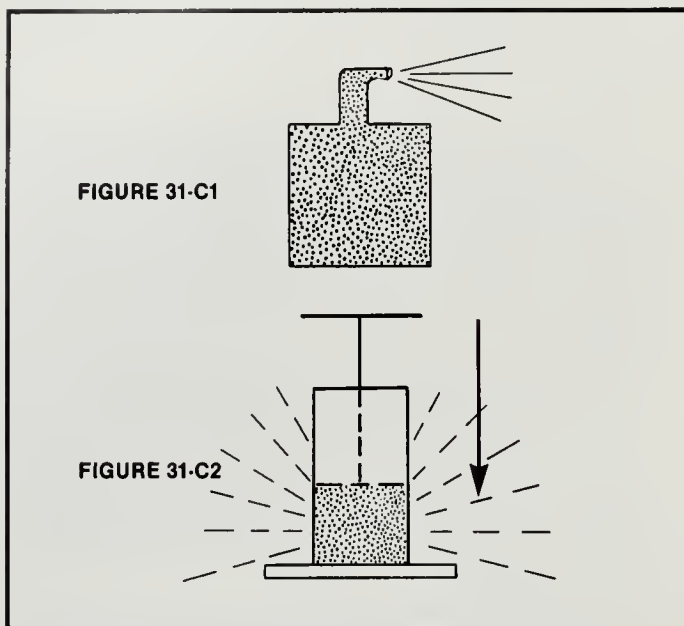

Some scientific books presently teach that a compressed gas cools or loses heat when it expands (see Figure 31-C1), and that a gas gains heat when compressed (see Figure 31-C2).

³¹
C. This is simply not true! What occurs is **just the opposite!** When the gas is compressed, the atoms within the molecules are pushed closer together, emit heat (electromagnetic energy comprising all atoms), and cool down. The gas feels hot “to the touch” for a given time because the atoms within the gas *emit* — not absorb — heat. [Such a process is analogous to

QUESTION: What does the statement “to become hot” really mean?

ANSWER: It means to *absorb heat*. To “become cool” means to *emit heat*. When the gas expands, the atoms absorb heat, *i.e.*, “gyroscopic” electromagnetic energy equal to that which the atoms originally lost on being compressed. This is why the gas will “feel” cold to your hand since the gas absorbs heat from your hand. When expanding, the gas molecules also possess inertia as a result of producing a continuous *Unobvious Force* when under pressure (similar to pulling on one end of a taut rope and having it snap in reaction). The concept of “speed” is also a determining factor — refer to the speed discussion in Section 30.

³¹
D. Examine several additional facts:

1. In the 17th century, Robert Boyle demonstrated that for a fixed quantity of gas, the volume and pressure are inversely proportional, *i.e.*, halve the volume and double the pressure; double the volume and halve the pressure.
2. In the 18th century, Daniel Bernoulli demonstrated that by increasing the temperature of a gas, one causes it to expand in a definite mathematical proportion, *i.e.*, double the absolute temperature of a gas under constant pressure and the gas volume doubles.
3. In 1787, Jacques Charles established that all gases held at constant pressure will expand in proportion to the amount of heat applied.
4. John Dalton, English chemist and physicist (1776-1844), observed a 50°F. increase in the temperature of a gas when its volume was halved by rapid compression.

QUESTION: What do these facts indicate?

ANSWER: The “gyroscopic” electromagnetic energy comprising atoms (which comprise molecules) has a particular “space area” necessary for any given substance. If one compresses the area demanded by this gyroscopic electromagnetic energy comprising atoms, such atoms will emit a definite, *minute* mathe-

“When the gas is compressed, the atoms within the molecules are pushed closer together, emit heat (electromagnetic energy comprising all atoms), and cool down.”

squeezing a wet sponge (atoms containing gyroscopic particles representing electromagnetic energy) and releasing water (the gyroscopic particles or electromagnetic energy flowing in a *random* direction). These same gyroscopic particles released from the atoms of the gas undergoing compression will then be absorbed by the atoms within your finger, causing such atoms to expand. Such expansion will be perceived by you as the sensation of “heat.”]

mathematical portion of this electromagnetic energy in the form of heat, *i.e.*, a random flow of gyroscopic particles. Such heat release permits a smaller demand area for the balance of the remaining gyroscopic particles (electromagnetic energy) comprising the atoms under pressure. If heat is added to a given system, the demanded area is increased due to the *minute* gain of additional gyroscopic particles resulting in a pressure rise relative to heat input.

E. PROOF:

31-E

(1) Raise a liquid's temperature to the boiling point and there will be a "pause" during which time heat (electromagnetic energy) is absorbed without a further rise in temperature, and enabling the liquid to transform into a gas.

31-E

(2) The reverse is true when the gas is condensing. There will be a "pause" in temperature decline at the boiling point. Although heat is steadily emitted, the temperature will remain constant until all the gas has liquified.

EXPLANATION: In PROOF (1), the liquid is expanding into a gas, consequently, the electromagnetic energy (gyroscopic particles) comprising the atoms' demanded area increases only with the absorption of additional electromagnetic energy input (heat) which results in expanding inertia (speed). In PROOF (2), the gas is decreasing in volume, consequently, the electromagnetic energy comprising the atoms' demanded area decreases as the atoms emit their electromagnetic energy composition received initially in PROOF (1).

31-E

(3) When the pressure on a liquid is lowered, its boiling point drops. When the pressure is increased, the boiling point rises. **QUESTION:** Why?

ANSWER: When the pressure is reduced upon a liquid, the electromagnetic composition of the atoms' demanded area expands and therefore has room to physically accept additional gyroscopic particles (electromagnetic energy). Therefore, such atoms can and do absorb additional heat. As this process occurs, additional gyroscopic particles are absorbed by the atoms to maintain the expanding demanded area. If the atoms are absorbing heat, a lesser temperature will be required to cause the atoms to absorb heat. As a result, the boiling point is lowered.

When the pressure on a liquid is increased, the "gyroscopic" electromagnetic composition of the atoms' demanded area has been decreased; consequently, such atoms will emit heat. If the atoms are attempting to emit heat, a greater temperature (or higher temperature difference) will be required to cause the atoms to absorb heat. As a result, the boiling point of the liquid will be higher.

31-E

(4) To raise the temperature of a gram of water by 1 °C. to its boiling point requires one calorie for each degree. However, when the 100 °C. boiling point is reached, 540 calories are needed to boil the water away.

QUESTION: What happened to this additional heat input?

ANSWER: The heat input expands the demanded area of the "gyroscopic" electromagnetic composition of

the atoms within the water molecule.

PROOF: Water expands more than 1,500 times as it turns into water vapor or steam! (This result is exactly as the brilliant Joseph Black originally predicted — see Section 31-B.)

Critics of the Caloric Theory stated that the Theory provides no explanation for the source of the motive power for steam expansion. It is quite obvious that the atoms of the demanded area (needed for the gyroscopic-type-particles of the electromagnetic composition within the atoms) have acquired considerable inertia with the capability to expand 1,500 times. Such expansion has the capacity for performing Obvious Work, *i.e.*, pushing a piston or turbine. However, pushing a piston or turbine places the vapor under a compression pressure. As a result of such pressure, heat is emitted and the vapor tends to condense and reduce the demanded area of the gyroscopic-type-particles of the electromagnetic composition of the atoms within the water molecule.

31

E. QUESTION:

31-E

(5) When a gas is compressed and the pressure maintained, why does the gas not emit heat continuously instead of only during compression?

ANSWER: Once compressed to a particular demanded area by a continuous force, the gyroscopic-type-particles of the electromagnetic composition of the atoms within the gas retain the vast majority of their electromagnetic energy (heat) within the atoms. Such retention results in an *Unobvious Force* against and *equal* to the force being continuously applied. When the gas is released, it will have inertia similar to the effect of pulling on a taut rope and causing it to snap. (See "speed" discussion in Section 30-L.)

Energy is internally used within the atoms of the gas and within the atoms of that substance applying the continuous force on the gas. The real distinction is between Obvious Work and Unobvious Force (as I have already explained earlier) and the fact that $E = MC^2$.

Actually I am amazed that others have had difficulty in understanding what is so clear to me. The facts are there! In chemical reactions, there are many instances where large quantities of electromagnetic energy (heat) are emitted or absorbed. Yet the Matter resulting from the reactions (supposedly) always weighs the same. **EXAMPLE:** In separating the hydrogen and oxygen molecules of water, large quantities of heat are required, *i.e.*, 5,400 °F. which is twice the melting point of iron. The resulting gas volumes of oxygen and hydrogen will *weigh the same as the water did*. If one strikes a match, the oxygen and hydrogen will unite back into water. Such water will *weigh the same as before*, but it will *release all the energy* (gyroscopic particles) originally acquired during the separation of the gases.

QUESTION: Is heat nothing, and yet it is capable of causing extreme changes in Matter?

ANSWER: No. Heat is electromagnetic energy (gyroscopic particles spinning and moving at the speed of light) and such electromagnetic energy comprises *all Matter*. In accordance with $E = MC^2$, it simply requires vast quantities of gyroscopic particles to comprise a single speck of Matter. It would therefore require an incredibly sensitive scale to weigh the difference of release or absorption of Matter on an atomic basis. Such a scale presently does not exist.

Lavoisier's classic series of experiments — which had scientific inadequacies — were intended to prove that Matter did not lose weight when burned or altered in chemical reactions. His statements are based upon a scale *he invented* that could weigh by a water drop the differences in the weight of Matter. This scale was an accurate invention for weighing commonplace items. However, Lavoisier's scale is *totally* inaccurate for weighing the loss of Matter in the form of gyroscopic-action-particles or electromagnetic energy in the form of heat, light, etc. Conclusion: Antoine Lavoisier invented an inadequate scale.

QUESTION: Considering the validity of $E = MC^2$, how much energy is contained within a drop of water? It should be obvious that such energy is vastly greater than any energy release occurring via Lavoisier's restrictive experiments using an inadequate weight scale. [Remember, if totally converted into energy via $E = MC^2$, the mass of a railroad ticket contains enough energy to run a large train around the world several times!] It is also very significant that Lavoisier as well as his scientific contemporaries had absolutely *no conception* that $E = MC^2$.

^{31-E}
(6) It is a known fact that Matter undergoes a volume change when its temperature is raised. The volume expansion within solids is small, *e.g.*, with a 10° rise in temperature the body of a bridge will expand approximately .04 inches for every 33 feet of its length.

FIGURE 31-E(6)

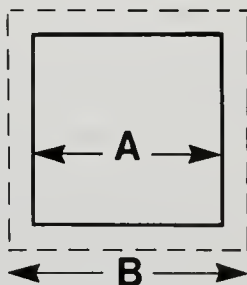

The cube of metal depicted in Figure 31-E (6) first occupies a certain volume "A," but after it has been

heated it occupies a greater volume "B" (exaggerated scale). In physics, this fact is presently referred to as a thermal expansion phenomenon!

This thermal expansion phenomenon is explained via my consistent Theory that heat is electromagnetic energy consisting of gyroscopic particles and that such electromagnetic energy comprises all Matter. Joseph Black also explained the thermal expansion phenomenon in the 1760's. The gyroscopic-type-particles that comprise all atoms in material "A" physically have a preferred demand area with respect to the total electromagnetic energy (gyroscopic par-

"Heat is electromagnetic energy (gyroscopic particles spinning and moving at the speed of light) and such electromagnetic energy comprises all Matter."

ticles) within the material at the moment material "A" occupies the space described in Figure 31-E (6).

[NOTE: A "demand area" is defined as that area physically required by the mechanical nature of a particular number of gyroscopic particles.]

At the moment material "A" expands to occupy space "B," additional gyroscopic particles or electromagnetic energy (heat) have been absorbed by the atoms of the material. This changes the preferred demand area of the gyroscopic-type-particles which comprise the atoms. In essence, the material absorbs heat by physically expanding to accommodate the resulting effects of the additional, quantitative input of gyroscopic particles.

^{31-E}
(7) Every gas has a "critical temperature" above which it cannot be liquefied.

QUESTION: Why is this so?

ANSWER: Different gases consist of different atoms which contain varying quantities of electromagnetic energy or gyroscopic-type-particles. Such atoms release a minute portion of these gyroscopic particles in the form of heat. This heat is released in varying amounts before the particular demand area is suffi-

"In essence, the material absorbs heat by physically expanding to accommodate the resulting effects of the additional, quantitative input of gyroscopic particles."

ciently reduced to permit the atoms to physically compress close enough to become a liquid.

EXAMPLE: Helium atoms have to release more gyroscopic particles to become a liquid at -452°F . than carbon dioxide atoms release to become a solid at -109°F . Here is an interesting fact: liquid helium re-

quires considerably less gyroscopic particle input to become a gas or vapor compared to carbon dioxide or water. However, it requires considerably less effort to cause the water vapor (steam) or carbon dioxide gas to release the newly-acquired gyroscopic particles (heat) than it does helium gas. This demonstrates that varying materials — depending upon the electromagnetic or gyroscopic-type-particles comprising the atoms — have definite, preferred space areas once the gyroscopic particles occupy that particular space area with respect to a particular gyroscopic particle or electromagnetic energy (heat) environment. Various environmental temperatures such as 75°, 32°, -109°, -400° composed of varying quantities of gyroscopic particles will generate different effects.

^{31-E}
 (8) The facts demonstrate that when atoms are subjected to compression in any state (gas, liquid, or solid) they emit electromagnetic energy (heat or random gyroscopic particle flow) and proceed to “cool down.” When the same atoms are subjected to expansion they absorb electromagnetic energy (heat) and “warm up.” The reverse is also true. If electromagnetic energy (heat) as a quantity of gyroscopic particles is added to atoms, then they will expand. If atoms have electromagnetic energy (heat) or gyroscopic particles subtracted from their physical composition, then such atoms contract, e.g., conduction, etc.

^{31-E}
 (9) At first glance, when water becomes frozen it appears to be an exception to the above rule. However, water is not an exception. Because the atoms do compress with respect to one another, as the molecules create and demand a definite area relative to adjoining molecules, such action causes the molecules to create a solid form of water occupying a larger space than it does as a liquid due to empty space. See Figure 31-E (9)a.

FIGURE 31-E(9)a



Since all molecules consist of atoms, the molecules react in accordance with the “instructions” of the atoms involved, i.e., the atoms of ice are compressed to their occupied area.

Such compression is proven by observational results first brought to my attention by my lovely and devoted wife: when water is frozen in ice trays, the ice will at times form as shown in Figure 31-E (9)b.

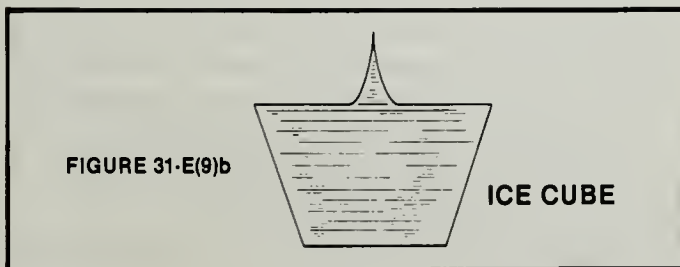

FIGURE 31-E(9)b

ICE CUBE

Such formation can only occur from atomic compression within the water affected by the freezing process. Increasing pressure internally applies compression within the ice cube and pushes or “shoots” the water from the center of the cube that has not yet frozen, but is super-cold and freezes very rapidly.

^{31-E}
 (10) Let’s now return to the cannon-boring experiments of Count Rumford in 1798 and the ice rubbing experiment of Humphry Davy in 1799 which were supposed to prove the Caloric Theory wrong and that heat was simply a result of motion.

The study of friction proves that heat release is the result of *surface compression* of the two materials involved! The coefficient of friction is defined as the ratio between two quantities — friction and pressure. Increasing contact pressure thus increases friction.

QUESTION: What does this really mean?

ANSWER: Surfaces are actually rough on materials that *appear smooth*. [See Figure 31-E (10).]

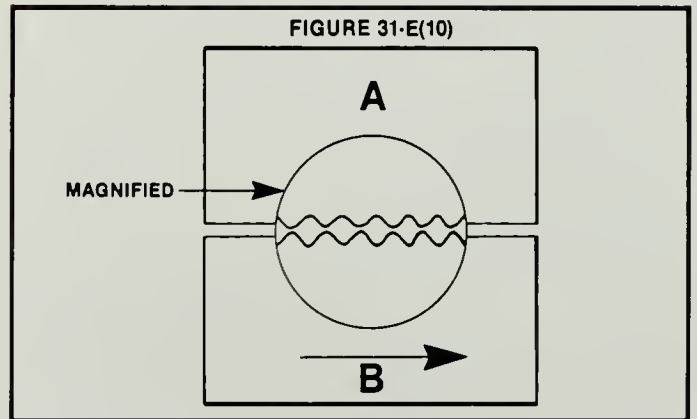

If material B is moved in the direction of the arrow, the the rough surface edges of materials A and B are compressed in *opposite* directions! The rough edges of material A will tend to be ground forward in the direction of the arrow and the rough edges of material B will tend to be ground backward, or in the *opposite* direction of the arrow.

CONCLUSION: All heat (electromagnetic energy) released from Matter as a result of friction is in reality the result of two surfaces being compressed in opposite directions. Therefore, friction is compression in a lateral direction *on the outer surfaces of matter* as a result of mechanical conveyance of energy pressure.

This can be simply proven by quickly rubbing the palms of your hands together. You will feel your hands release heat which comes from the atoms within your hands being compressed in a lateral direction. As soon as you stop rubbing your hands and hold them apart, you will feel the opposite results. Your hands will now feel cool for having released the heat, i.e., the gyroscopic particles or electromagnetic composition of your hands.

What is the conclusion of what I have shown with respect to heat?

All heat emitted from Matter — whether a result of chemical reaction, mechanical compression reaction, conduction, etc. — is *released* as a result of the gyroscopic-type, electromagnetic particles (which comprise all atoms) being *reduced* past the point of their original demand area. As a result, such atoms will emit electromagnetic energy (heat) to adjust to the *smaller*, required demand area now occupied by the balance of the vast quantity of gyroscopic particles (electromagnetic energy) remaining in the Matter.

“All heat emitted from Matter is released as a result of the gyroscopic-type, electromagnetic particles (which comprise all atoms) being reduced past the point of their original, demanded area.”

All heat absorption from Matter — whether a result of chemical reaction, mechanical compression reaction, conduction, etc. — is *absorbed* as a result of the gyroscopic-type, electromagnetic particles (which comprise all atoms) being *expanded* past the point of their original demand area. As a result, such atoms will absorb electromagnetic energy (heat) to adjust to the *increased* required demand area of the total electromagnetic energy then in the Matter.

It would therefore appear that energy tends to flow from a condition of higher mechanical pressure (within one atom) to a condition of lower mechanical pressure (within another atom). I must stress, however, that I do not wish this concept (or any of my other concepts) to be interpreted (by those who follow me) in such a manner that the interpretation stifles further questioning or curiosity by a young person learning this informa-

“All heat absorption from Matter is absorbed as a result of the gyroscopic-type, electromagnetic particles (which comprise all atoms) being expanded past the point of their original demanded area.”

tion for the first time. The above statement may prove to be totally incorrect since I have obviously not seen or envisioned everything and all possible conditions within the Universe.

FURTHER CONCLUSIONS: The critics of the Caloric Theory stated that heat was simply the result of motion. They were wrong. Heat is the result of motion as stated by the supporters of the Kinetic Theory who criticized the Caloric Theory. However, this view does not constitute proof against the validity of caloric in the form of *electromagnetic energy*. Because the Caloric (electromagnetic energy) Theory indicates changes in the amount of caloric (electro-

magnetic energy) in Matter, heat *does have* motion. As you know from earlier Sections in this Book, gyroscopic particles move at the speed of light. Because Joseph Black’s work anticipated $E = MC^2$, his brilliant insight was far in advance of his time. We owe him recognition and respect for his accomplishments. (See Section 31-B.)

Heat is electromagnetic energy (consisting of gyroscopic particles). Gyroscopic particles (or electromagnetic energy) comprise all Matter. Alterations in the *beat* (gyroscopic particles) of Matter cause a change in the amount (gyroscopic particles) of Matter in accordance with $E = MC^2$.

32. I shall now proceed to constructively refute the negative doctrines that are a result of the present “Three Laws of Thermodynamics.”

A. FACTS:

1. **The Three Laws of Thermodynamics were conceived without an understanding of the relationship between heat (gyroscopic particles/electromagnetic energy) and Matter.**
2. **The Three Laws of Thermodynamics were conceived without an understanding that there is an energy relationship other than the simplicity of Work = Force X Distance, Power = $\frac{\text{WORK}}{\text{TIME}}$, and Force = Mass X Acceleration.**
3. **The Three Laws of Thermodynamics were originally conceived without any knowledge, understanding, or anticipation of Einstein’s equation of $E = MC^2$.**
4. **The Three Laws of Thermodynamics were originally conceived without an understanding of Gravity, Electricity, Magnetism, Inertia, Matter, and Planetary Motion.**

³²
B. QUESTION: If none of these things were understood at the time that the Three Laws of Thermodynamics were conceived, how can these three laws be so “all encompassing” as to be capable of predicting — on a seemingly “infallible” basis — the “Doom of the Universe” and the “Total Impossibility of Perpetual Motion?” Those who made such predictions *must have understood the mechanical workings of the Entire Universe.*

QUESTION: Did they?

“The Three Laws of Thermodynamics were conceived without an understanding of the relationship between heat (gyroscopic particles/electromagnetic energy) and Matter.”

C. The "First Law of Thermodynamics" (1850) states:

"Energy can be exchanged in the form of heat or of mechanical work, but its total quantity remains constant."

The First Law of Thermodynamics is one of the most positive scientific statements ever made, although this was not the initial intent of this Law.

QUESTION: What does this Law say?

ANSWER: If one cannot destroy energy, this means that energy always exists. If energy always exists, one can always use it. The Facts have indicated to me that the gyroscopic particle composition of all Matter is totally in accord with the First Law of Thermodynamics since it appears that the energy (spin speed) of the gyroscopic particle cannot be consumed!

D. The "Second Law of Thermodynamics" (1850):

The First Law of Thermodynamics proves that the implications of the Second Law of Thermodynamics are incorrect! The Second Law of Thermodynamics represents a conclusion concerning the use of heat based upon primitive, 19th-century mechanical devices. The "Second Law of Thermodynamics" may well apply to such primitive mechanical devices, but it has absolutely nothing to do with the implications of $E = MC^2$!

tion for heat flow laid the foundation for one of the basic laws of physics: the Second Law of Thermodynamics. The law was first formulated in 1850 by the German physicist, Rudolf Clausius, who stated, "It is impossible for a self-acting machine, unaided by any external agency, to convey heat from one body to another at a higher temperature."

The essence of the Second Law of Thermodynamics is this: heat will not flow of its own accord from a cold place to a hot one. Again, I repeat that this statement has absolutely nothing to do with the essence of heat and demonstrates a total lack of understanding that heat is gyroscopic particles (electromagnetic energy) which comprises all Matter and that $E = MC^2$.

In physics it is presently believed that this unidirectional flow of heat, as stated by the Second Law of Thermodynamics, implies the "Doom (or heat death) of the Universe." I vigorously disagree with this unfounded statement! All of the facts now presented in science prove this closeminded statement to be totally incorrect! This negative statement has been an extreme hindrance to the diligent progress of science since it closes one's mind to creative thought and has succeeded in unjustly influencing young minds that were taught to accept it.

Electromagnetic energy is *perpetually* changing from energy to Matter and from Matter to energy. [While I fully realize that the use of the word "perpetual" violates current scientific taboos, I will do so anyway.] The gyroscopic entity I have described

"The First Law of Thermodynamics proves that the implications of the Second Law of Thermodynamics are incorrect!"

As I have demonstrated earlier, many of the 19th-century scientists believed heat to be only the result of motion. They did not understand that heat was simply the conversion of Matter into gyroscopic particles or electromagnetic energy (heat) as implied by the brilliant work of Joseph Black. Nor did they realize that heat (consisting of gyroscopic particles or electromagnetic energy) was convertible into Matter. They were completely ignorant concerning $E = MC^2$. In their ignorance, they would have said that anyone claiming such a statement was stupid. In my opinion, Joseph Black would have readily accepted the implications of $E = MC^2$.

In 1824, Sadi Carnot published a paper entitled "Reflections on the Motive Power of Heat." Carnot had discovered that heat must flow "downhill", *i.e.*, heat must change from high to low temperatures to perform work. Such a conclusion was based upon the observation of primitive inventions and has no real connection with the essential nature of heat or $E = MC^2$. Joseph Black understood the nature of heat as early as 1760 — others did not.

By 1850, it was concluded throughout the scientific community that Carnot's discovery of a definite direc-

tion in this Book perpetually spins and travels at the speed of light in accordance with $E = MC^2$. Even if all physical Matter could become exactly the same temperature, the gyroscopic particle (electromagnetic energy) within Matter is *still moving at the speed of light*. Any Matter could still be caused to release its incredible electromagnetic energy (gyroscopic particle) composition!

A chain reaction could be induced within a mass the size of a planet, thereby causing the mass to release its electromagnetic energy (gyroscopic particle composition) at a rate as rapid as that of the Sun. The mass would then cause a source of heat greater than its surroundings which were retaining the major portion of their gyroscopic particles (electromagnetic energy) composition within the physical boundaries of the materials. All heat is gyroscopic particles (electromagnetic energy). All Matter is gyroscopic particles (electromagnetic energy). All Matter can release its gyroscopic particles in the form of heat, light, electrical current, electromagnetic fields, electromagnetic waves, electromagnetic radiation, or in smaller quantities of its total physical form. However, it makes no difference in what form Matter is released, since it is

always composed of gyroscopic particles (electromagnetic energy).

The reverse is also true: all gyroscopic particles (electromagnetic energy) can be converted into physical Matter! Having a basic understanding of the ingenious properties of the gyroscopic particle (electromagnetic energy) composition of all Matter in the Universe, *the mathematical law of probability tells me that the probability of the Universe undergoing a "heat death" is zero.*

"The gyroscopic entity I have described in this Book perpetually spins and travels at the speed of light in accordance with $E = MC^2$."

One of Joseph Black's important discoveries was that different substances have different capacities for absorbing or emitting heat (electromagnetic energy)! **EXAMPLE:** If 1 kg. of iron at 80°C. is immersed in 1 kg. of water at 40°C., then the equilibrium temperature is found to be 43.7°C. In other words, *the same amount of heat (electromagnetic energy) has resulted in a much greater temperature change in the iron than in the water.*

The same unfounded statement of the Second Law of Thermodynamics is also used in present physics to have stamped the final label of "FUTILE" on the quest for "Perpetual Motion." I would agree that "Perpetual Motion" would be futile as long as one accepts the validity of the Second Law of Thermodynamics as explaining everything in the Universe for all time. However, I challenge such validity. It is easy to recognize that in this sense, the Second Law has operationally been a deliberate attempt to close young minds who would be otherwise willing to question the "finality" of the Second Law of Thermodynamics. I am sure that there are many who read this Book who have been so unjustly influenced. Please recognize that the conversion of physical Matter to electromagnetic energy (gyroscopic particles) and from electromagnetic energy (gyroscopic particles) back to physical Matter *is perpetual* throughout the Universe and this phenomenal energy change can be conceptually understood and technologically harnessed in the immediate future for the incredible benefit of humanity!

32

E. The "Third Law of Thermodynamics" (developed 1888-1902):

In 1902, measurements of the heat reaction of various substances were examined, and it was found that the free energies experienced an increasingly *small variation* as the reaction approached absolute zero.

This line of thought was initiated in 1848 by Lord Kelvin (William Thomson). Knowing that when cooled one degree from 0° to -1°C. a gas loses 1/273 of its pressure, Kelvin reasoned that at -273°C., gas should have no pressure and he called -273°C.

absolute zero. Scientists at the time further reasoned that if "cold" is simply the absence of "heat," then there should be a point when there is absolutely no heat. This reasoning demonstrates a complete lack of understanding that heat is actually electromagnetic energy (gyroscopic particles) which comprise all Matter and that $E = MC^2$. [Kelvin's knowledge is valuable, however, in terms of designing my Pioneering Invention where atom unalignment is important since heat causes random motion and rapid atom unalignment.]

In accordance with the above concept regarding the absence of heat, the Third Law of Thermodynamics was proposed. It states that every substance known to man undergoes entropy, *i.e.*, a measure of the availability of energy to perform work that approaches zero as the temperature approaches absolute zero (-273.16°C. or -459.69°F.).

Einstein's equation of $E = MC^2$ and the work I have accomplished prove that this statement concerning entropy is totally incorrect.

Kelvin's results are explained by my prior discussion that heat (gyroscopic particles/electromagnetic energy) loss from Matter causes the atomic entities to demand a smaller area. This is why gases lose pressure at low temperatures since they are becoming a liquid state.

The concept that cold is the absence of heat should be corrected as follows: Cold is simply a condition of less gyroscopic particles or electromagnetic energy (heat) in Matter. As long as one has Matter, one still has gyroscopic particles (electromagnetic energy or potential heat). Matter at -459.69°F. *still contains tremendous electromagnetic energy* (or heat if properly released) or vast quantities of gyroscopic particles spinning at the speed of light. Only when Matter is gone, is all potential heat gone. The mechanical essence of $E = MC^2$ is the gyroscopic-action-particle which is the basic building entity of all Matter.

"Matter at -459.69°F still contains tremendous electromagnetic energy."

32

F. It is totally amazing to me that these three laws of thermodynamics have been so long accepted, knowing that their total premise is one of negativism which completely stops the creative thinking processes of a student who is motivated to question or discover a method for a better energy invention that would ultimately be of service to humanity. However, *in spite of the negative intentions of those who developed it, the First Law of Thermodynamics proves just the opposite!* It is a most positive, scientific statement.

Although this may appear superficially paradoxical, I will make the positive statement that *there is no place in science that negativism should be allowed to exist!* The entire history of science has proven over and over again that, whenever it has been thought that something was not possible, it later turns out to be possible. Therefore, as the facts have proven,

science should put forth positive statements of hopes and dreams that will perpetually stimulate the creative processes of the human mind. In contrast, throughout my sincere, scientific efforts of nearly two decades, I have had to fight against many negative "scientific statements" that were and are wrong. Such injustice has not been unique to my efforts but, on the contrary, it has been the common fate of most creative individuals throughout the History of Science.

Having a full awareness of this knowledge, I am bound to the task that my efforts will cause long-overdue changes to occur within the teaching system which — prior to this time — has stifled questioning, creative thoughts, and has hampered the advancement of science and the Human Race. It is my deep, caring belief that in years to come, our descendants will look back upon these times as truly the "Dark Ages," whereby they will state: "My parents and ancestors were taught in such a manner that the natural curiosity with which they were born was significantly stifled." In a later chapter I will discuss this educational problem in greater detail.

Chapter 19

ASTRONOMY

"It certainly looks as though the lines of force either must go out to join the interstellar gas or they must join up at a distance far outside the Sun."

— Fred Hoyle

The following is a very special tribute to Michael Faraday, whom I quote:

"Here end my trials for the present. The results are negative; they do not shake my strong feelings of the existence of a relation between gravity and electricity, though they give no proof that it exist."

[from *Michael Faraday* by L. Pearce Williams — originally from *Experimental Researches in Electricity*, paragraph (2717)]

Throughout the prior work I have presented, I have proven Faraday's brilliant insight correct. The following information further corroborates such insight.

33. A. I wish to thank Dr. Robert Smith (Chief, Orbital Space Environment Branch, Space Sciences Laboratory, NASA, Huntsville, Alabama) and Dr. Ellsworth Huntington (now deceased) whose work Dr. Smith forwarded to me. Dr. Smith is a thinking, questioning scientist who spoke in my behalf when others would not.

[Refer to Dr. Smith's letter of June 22, 1976.]

³³

B. Dr. Smith discussed my work with others for several years. When Dr. Smith found that he was unable to encourage others to speak out regarding my work, he then wrote an even stronger letter in my behalf. [Refer to Dr. Smith's letter of March 20, 1979.] I hope the reader recognizes the scientific courage and intellectual honesty of Dr. Smith, since he had never seen a working Prototype of my Invention.

National Aeronautics and
Space Administration



George C. Marshall Space Flight Center
Marshall Space Flight Center, Alabama
35812

33-A

Reply to Attn of: ES44

June 22, 1976

Mr. Joseph W. Newman
1521 Deerwood Drive, East
Mobile, AL 36618

Dear Joe:

I have read your article several times, believe that it is very worthwhile,
and that it should be studied in much more detail.

I am sending you a Xerox copy of several pages of a book by Huntington that should be of great interest. It contains some of the data we discussed about inclinations of the various planets' orbits to the ecliptic. It also contains much information that supplements and complements your work. I have not read the entire book which can only (as far as I know) be obtained from the Library of Congress. If these pages are good examples, then the entire book would be of great value to you.

I intend to discuss your work with Dr. Willis Webb, an atmospheric scientist at the White Sands Missile Test Range, N. M., this week. He has a newly developed theory on the electrical structure of the earth. I intend to give him a copy of your paper and ask him to contact you.

I have thought about your smoke experiment in the jar and I believe that the particles that are suspended in the air are more than likely ionized and, therefore, should align themselves with the magnetic field lines. They probably stay ionized for long periods of time, because there are not enough other particles in the jar to make them lose their charge through collisions - the way they would if they were outside the jar.

In my opinion, the only way you can get the approval and widespread dissemination of your work that you want is through publication - preferably in a technical journal like the Journal of Geophysical Research, or the Journal of Atmospheric and Terrestrial Physics. I would highly recommend the former and advise you to spend the time and effort required to get it accepted for publication.

Endorsements by many individuals are not as valuable as getting your work published in a technical journal. While this can never measure the true worth of a person's research activities, at the present time it is used by members of the science community in that way.

I am going to continue to study your work and I will provide you with additional relevant data and information as I find it. Once again, I think you should continue to expand your efforts, as it appears as if the results could be very significant.

Please let me know if I can help you in any other way.

Sincerely,



Robert E. Smith
Chief, Orbital & Space Environment Branch
Aerospace Environment Division
Space Sciences Laboratory

Enclosure:
"Earth & Sun"

*See Dr. Smith's letter
of March 20, 1979.*

125 Westbury Drive
Huntsville, AL 35802
March 20, 1979

To Whom It May Concern:

Mr. Joseph W. Newman and I have been corresponding about his revolutionary concepts of magnetic fields for the past several years. I have not seen his experimental set-up but if his write-ups of the procedures and results are correct, then several laws of physics may need to be re-examined. If the manner in which Joe conducted his experiments and the results were made known to the industrial or engineering communities, then, in my opinion, several companies and/or individuals possess the expertise and capabilities to construct the hardware required to fully exploit the apparent capability of his new concepts.

Robert E. Smith

Robert E. Smith

*Dr. Smith is Chief of Space
Environment Branch
at NASA, Huntsville.*

C. Earlier in this Book, I have demonstrated the Unobvious electromagnetic (gyroscopic particle) effect of Matter and its "unequaling effect" which has been popularly termed "gravity." I have demonstrated the gyroscopic mechanical motion of electric charges and magnetic fields which attract and repel. I have demonstrated how electric current (consisting of gyroscopic particles) is released from electromagnetic fields. I have demonstrated that the negative and positive charges moving in an electromagnetic field are in reality a gyroscopic-type-particle traveling in different directions, comprising all Matter, and creating the effect of inertia in Matter. I have shown that the gyroscopic-action-particle is literally the mechanical essence of Einstein's equation of $E = MC^2$. I have also demonstrated to any individual with ade-

***"It is my Theory
that a central electromagnetic field
completely encompasses our Galaxy's
electromagnetic field and causes our
Galaxy to align with and orbit this central
electromagnetic field."***

quate powers of reasoning that a new source of energy can be released from gyroscopic fields of force which are comprised of gyroscopic particles in motion. Considering these facts scientifically, one would surely conclude that the *entire* Universe is composed and controlled by these gyroscopic particles (electromagnetic energy).

Current astronomy books use words like "queer, odd, and peculiar" to describe many of the motions of planets and their satellites. Yet, such books provide no reason for these motions other than saying that "they just occur that way."

I will now explicitly apply the previous information presented in this Book to our Solar System, as well as the Universe, and I will demonstrate by using the laws of Magnetic and Electrical Forces that there is a particular reason for *all* astronomical motions.

The following information must all be Mastered, since its mechanical essence is applicable to space travel, food production, and the future safety of life as we know it on planet Earth.

D. It is my Theory that a *central electromagnetic field* completely encompasses our Galaxy's electromagnetic field and causes our Galaxy to align with and orbit this central electromagnetic field. Our Galaxy's electromagnetic field causes the Sun to align with and orbit within our Galaxy since this electromagnetic field encompasses the Sun's own electromagnetic field. In turn, the Sun causes all the planets within our Solar System to align with and orbit the Sun because the Sun's electromagnetic field encompasses all of its planets and their respective electro-

magnetic fields. Such planetary, electromagnetic fields include the Earth's electromagnetic field which causes the Moon to align with and orbit the Earth since the Earth's electromagnetic field encompasses the Moon's electromagnetic field as do the other planets' fields encompass their respective moons. In essence, *everything in the Universe* moves in alignment with the gyroscopic-action-entity composition of respective electromagnetic fields. The observed interaction of these unobserved electromagnetic fields in space is called "gravity." In reality, gravity is the "unequaling effect" of the gyroscopic-action-entity composition of all Matter.

E. In 1967 I wrote a 25-page document and sent it to the physics and astronomy departments of fifty-six major universities in the United States. [These universities are listed in a later chapter.] In this document I made the following prediction:

"It is also stated that the Earth's magnetic North and the true North are different. However, I contend that they are not different in the sense that is suggested. The magnetic North and the true North are one and the same, the difference being mathematical points of contact in reference to the Earth and its movements through and by electromagnetic fields of force."

I was very certain from my own simple experiments and the known laws of electromagnetic induction that the Earth's magnetic field was being warped into Space as the Earth's magnetic field merged with the Sun's magnetic field.

F. Present astronomy teachings state that the Earth's magnetic axis makes an angle of approximately $11\frac{3}{4}^\circ$ with respect to the Earth's true axis and that the magnetic axis and true axis are different. This conclu-

***"In essence, everything in the
Universe moves in alignment with the
gyroscopic-action-entity composition
of their respective electromagnetic fields."***

sion has been made because the point on the Earth's surface where a magnetic pointer will point straight down was found to be approximately 1500 miles from the Earth's true axis of rotation. (See Figure 33-F.)

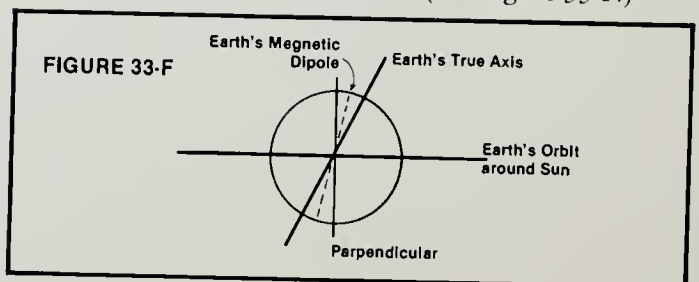

QUESTION: What would have been the conclusion if the Earth's magnetic axis had been found to be in the same location as the Earth's true axis?

This prior conclusion would appear to be a logical scientific conclusion until subjected to a rigid scientific scrutiny. Experimentation will verify that a smaller magnetic field will always be *warped* when brought under the influence of a larger magnetic field. The Sun has a larger electromagnetic field than the Earth's electromagnetic field. Consequently, I was certain that the Earth's electromagnetic field must be warped into Space. I was also certain that the Sun's electromagnetic field was warped as it aligned with our Galaxy's electromagnetic field. [I was also certain that the Moon's electromagnetic field aligned to the Earth's electromagnetic field and resulted in the Moon's observed motion and position in Space.]

For a number of years I diligently sought to have other scientists debate with me concerning my astro-

“Experimentation will verify that a smaller magnetic field will always be warped when brought under the influence of a larger magnetic field.”

nomical concepts. However, such an attempt on my part was to no avail. In 1974 I concluded from the known Facts in Astronomy that there would be a mathematical relationship of recorded astronomical data which should prove that I was correct. If I could assemble this data in view of my mechanical teachings, then others would listen and open their minds.

³³ **G.** The following data represents the very first information I assembled. I did not simply select these data figures from a large group of figures and then attempt to make them match. They are and were the only recorded figures available. I assembled this data and searched for a mathematical connection since all of my experiments and the known laws of electromagnetic induction convinced me beyond any doubt that there would be a connection.

34. A. Since February, 1974, the amazing mathematical proof that I assembled represents the exact results I predicted from experiments in 1967! [Please observe that we will be discussing DEGREES X MINUTES. I conservatively used 90° X 60'. However, the possible angles could have been anything within 360° X 60'. The conservative numbers I use are more than sufficient for the PROOF which I sought.]

³⁴ **B. PROOF:** The Earth's magnetic axis at the Earth's surface “traces out” two circles every day, each circle having an approximate 23°, 30' cone that is equal to the radius of the circles having an approximate 23°,

27' cone traced out by the Earth's true axis every 25,800 years.

³⁴ **C.** The probable, mathematical odds of this data happening by accident are 29,160,000 to 1. (Degrees X minutes = 5,400 X 5,400.)

QUESTION: Why isn't the degree of angle between the Earth's true axis and its magnetic axis 89°, 2' or 3°, 58' or *any other* than 23°, 30', which produces mathematically exact results? (See Figure 34-J.)

³⁴ **D.** In Section 33-E, I have already stated that astronomy currently teaches that the Earth's true axis and the Earth's magnetic axis are different.

³⁴ **E.** In 1967, I predicted that the Earth's true axis and the Earth's magnetic axis were **one and the same**. Moreover, I predicted that the Earth's magnetic axis was being warped into Space by the Sun's magnetic field and such warpage caused the *effect* of the Earth's “true axis.”

³⁴ **F.** These mathematical Facts in Sections 34-B and 34-C are proof that my prediction is correct. (Sections 34-G and 34-H represent further proof.)

³⁴ **G.** The angular degree of the cone traced by the Earth's magnetic axis at the Earth's surface (approximately 23°, 30') is equal to the angular degree of the Earth's “true axis” to the perpendicular of the plane of its orbit around the Sun (approximately 23°, 27'). (See Figure 34-J.)

³⁴ **H.** The mathematical odds of probability for these measurements happening by accident are also 29,160,000 to 1, *i.e.*, 5,400 degrees X 5,400 minutes. (Refer to the “QUESTION” in Section 34-C since it applies here.)

“In 1967, I predicted that the Earth's true axis and the Earth's magnetic axis were one and the same.”

³⁴ **I.** Current astronomy teaches that a peculiarity of the of the Earth's position in Space is its tilt with respect to the plane of its orbit around the Sun. The Earth is canted at a fixed angle of approximately 23½ degrees. No further explanation is offered except to say “it just exists this way.”

³⁴ **J.** The mathematical Facts in Sections 34-B and 34-C combined with those of Sections 34-G and 34-H are strong proof that the Earth's true axis is the center of the cone traced by the Earth's magnetic axis. The Earth is tilted from the perpendicular of its orbit around the Sun by the warpage of the Earth's magnetic axis which aligns with the curvature of the Sun's magnetic lines of force. (See Figure 34-J.)

Left Side

Earth's True Axis

Perpendicular

Degree of Angle of the perpendicular to True Axis

The Earth's True Axis traces out 2 circles — each having a 23° 27' radius every 25,800 years. This equals the degree of the circle traced out by the Earth's Magnetic Axis each day. The mathematical odds against this fact happening are "29,160,000 to 1".

Earth's Orbit

5° 9'

Moon's Orbit

Degree of Angle Between Earth's True Axis and Earth's Orbit around Sun

68° 53'

Observe that the Moon's True Axis aligns with the Earth's electromagnetic lines of force above and below the Earth's equator.

NORTH MAGNETIC AXIS

EARTH

NORTH TRUE AXIS

Degree of Angle Between Earth's True Axis and Magnetic Axis = 11° 45'

These three angles equal 11° 45' = 5° 9' + 6° 41'. Observe, that if the tilt of the Moon's Orbit changes, then the tilt of the Moon's True Axis must also change. The mathematical odds against the two angles of the Moon being an equal degree of angle between the Earth's True Axis and Magnetic Axis are "157,484,000,000 to 1".

5° 9'

Around Sun

Around Earth

MOON

6° 41'

Earth's True Axis

Right Side

*all angles are approximate

SIMULATION OF THE EARTH'S MAGNETIC FIELD ONLY. THE LINES OF FORCE TRAVEL TO THE EARTH AND THE EARTH ALIGNS WITH THE CURVATURE OF THE SUN'S MAGNETIC LINES OF FORCE, JUST AS THE MOON ALIGNS TO THE CURVATURE OF THE EARTH'S MAGNETIC LINES OF FORCE. ELECTROMAGNETICALLY, THE OTHER PLANETS ALSO HAVE THE SAME RELATIONSHIP TO THE SUN.

FIGURE 34-J

35. Current astronomy teaches that the Moon's axis is tilted by approximately $6^\circ, 41'$ to the perpendicular of the plane of its orbit around the Earth.

³⁵**A.** No reason is provided for such tilt other than "it exists this way."

³⁵**B.** Current astronomy teaches that the Moon's orbit is inclined at approximately $5^\circ, 9'$ to the Earth's orbit.

³⁵**C.** No reason is provided for such orbital inclination other than "it exist this way."

³⁵**D.** During my early research in 1967, I proposed 17 statements concerning how *all* bodies move in the Universe. One of these statements is:

"The degree of angle of any single body as it orbits another body depends upon several factors:

^{35-D}**(1)** *The number of degrees North or South past the magnetic equator that both poles of the orbiting body are within one pole of the particular body being orbited*

^{35-D}**(2)** *The orbiting body's magnetic or electrical field*

^{35-D}**(3)** *The orbiting body's weight and area*

^{35-D}**(4)** *The distribution of the orbiting body's weight*

^{35-D}**(5)** *The relation of the orbiting body to the rotation, magnetic or electrical field, weight, and area of the body being orbited."*

³⁵**E.** As related to the Moon, for example, what I am saying in Statement 35-D is the following: "Whatever degree of orbit the Moon has around the Earth would affect the tilt degree of the Moon with respect to the Moon's orbit. *Both the Moon's tilt and its orbit are affected by their relation to the Earth's magnetic and electrical fields.*"

³⁵**F.** In 1974, the following statistics are the very first I assembled from available astronomy data. I must stress that I did not select these statistics from a large group of statistics and then attempt to match them. These were the only quoted statistics regarding the position of the Moon with respect to the Earth.

³⁵**G.** The degree of angle of the Moon's orbital inclination with respect to the Earth's orbit (approximately 5 degrees, 9 minutes), plus the degree of angle of the Moon's axis-tilt with the perpendicular to its orbit around the Earth (approximately 6 degrees, 41 minutes) is equal to the degree of angle of the Earth's magnetic axis with respect to that of the Earth's true axis (approximately 11 degrees, 45 minutes). (Refer to Figure 34-J.)

³⁵**H.** The mathematical odds for the probability of these statistics being "accidentally" equal are 157,464,000 to 1, *i.e.*, $5,400 \times 5,400 \times 5,400$.

QUESTIONS:

1. **Why isn't the degree of angle between the Moon's orbit and the Earth's orbit $1^\circ 15'$, or $63^\circ 14'$, or any other degree than the approximate figure which provides a continuous, mathematical relationship? (See Figure 34-J.)**

2. **Why isn't the degree of angle — for the tilt of the Moon's axis to the perpendicular of the plane of its orbit — any other than this exacting statistic? (See Figure 34-J.)**

3. **Why isn't the degree of angle between the Earth's true axis and the Earth's magnetic axis any other than this exacting statistic? (See Figure 34-J.) [The answers to QUESTIONS 1 and 2 equals approximately $11^\circ 50'$ which equals QUESTION 3 of approximately $11^\circ 45'$.]**

³⁵**I.** The mathematical facts and statistics in Sections 35-G and 35-H are strong proof that *both* the Moon's tilt (of its axis to the perpendicular of the plane of its orbit) and the degree of angle between the Moon's orbit and the Earth's orbit are indeed relative to the electromagnetic (gyroscopic particle) field of the Moon intertwining and aligning with the electromagnetic (gyroscopic particle) field of the Earth. As a crude analogy, one could imagine the Earth and Moon surrounded by billions of "invisible streams of gyroscopic particles" spinning at the speed of light and traveling at the speed of light where each gyroscopic particle within a given stream has an "electromagnetic coupling effect" upon the next gyroscopic particle to generate a hydraulic pressure throughout the entire "stream." In addition, each stream is capable of intertwining or meshing with and into one another. (As I have already shown, gravity represents the "Unobvious Effect" of the electromagnetic [gyroscopic particle] "Unequaling Effect." Refer to Figure 34-J with this knowledge in mind.)

³⁵**J.** Please realize that I made rigorous statements predicting these results from mechanical tests conducted seven years *before* I obtained these astronomical statistics. In addition, I discovered the Fact that all the recorded astronomical statistics coincide *exactly* with the prediction, *i.e.*, the mathematics of probability indicate that the chances of the Facts occurring "by accident" are so unlikely as to be almost impossible.

36. Because they were unjustly taught in Astronomy to memorize the statement "the Sun's magnetic field reverses on a 22-year cycle," there are those who will blindly state that all of the above Facts discussed in this Chapter are incorrect.

36

A. The following represents my scientific reasoning concerning why the Sun's general magnetic field **does not reverse**:

36

B. Present scientific data states:

"Sunspots fade in strength every eleven years. This pattern is but a phase of a twenty-two year cycle in which the Sun's magnetic field reverses itself.

"The eleven-year cycle of the number of sunspots doubles if the difference in magnetic polarity is taken into account. Information shows the polarity of the leading spot in a bipolar group during a cycle in one hemisphere have North polarity, while those in the other hemisphere have South polarity. As the cycle progresses, the spots appear, on the average, at lower latitudes. However, the leading spots of the Northern hemisphere still have a North polarity and those of the Southern hemisphere a South polarity. During the next eleven-year cycle, the leading spots which appear at high latitudes of both hemispheres are of reversed polarity. Therefore, the real cycle of the sunspots is 23 years and not 11.5, which would be the length of the cycle if the spots were judged solely on their number. And that one major reversal of the Sun's magnetic field took place in 1957-1958 when sunspot activity was at a maximum. During this period, the North magnetic pole of the Sun became magnetically a weak South pole and the South pole became a weak North pole."

36

C. Present scientific data also states:

"... how magnetic fields of the sunspots and of the Sun are studied by the Zeeman Effect (the phenomenon of spectral lines splitting due to the presence of a magnetic field of sufficient intensity) and that it is not easy to measure solar magnetic fields of hundreds of gauss. This raises the question: does the Sun have a permanent, general magnetic field?"

"If a permanent magnetic field were present, it would be manifested as a widening of the spectral lines from any point on the photosphere and not just from the sunspots. Because the spectrum of the photosphere is often observed with extremely sensitive instruments, it can be stated with certainty that if such a general field exists, it must be extremely weak. Its intensity cannot be greater than some tens of gauss." (Emphasis added.)

36

D. In conjunction with my experiments that follow, these above two quotations present factual, scientific arguments as to why the Sun's general magnetic field has not been observed, but only the general polarity of sunspot activity.

From my original writings, the following information provides a description and drawing of an experiment I conducted on Wednesday, 10 P.M., April 3, 1968: (See Figure 36-D.)

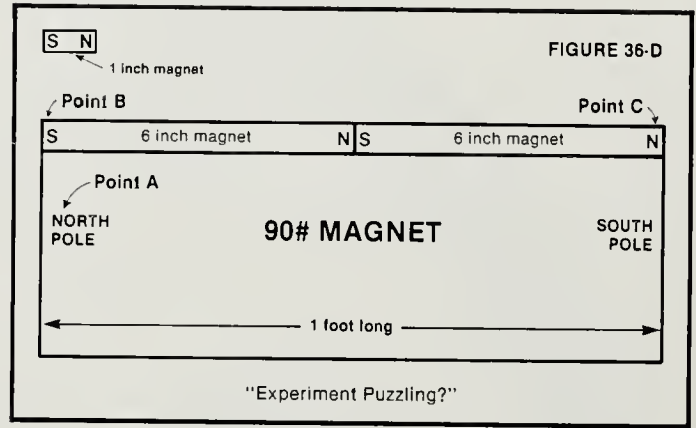

"When a large 90-pound magnet (previously described) is laid down and two, smaller, 1-inch diameter, 6-inch long magnets are placed end to end and placed where they are attracted parallel to the 90-pound magnet, they appear to have the same polarity as the large magnet to which they are attracted.

"There should be a South pole at point B and a North pole at point C, but when the South pole of a smaller 1/4-inch diameter, 1-inch long magnet is placed at point A on the large, 90-pound magnet and is attracted, it should be repelled at point B on the 6-inch long magnet's South pole. However, it is attracted there also, but if they are taken away from the 90-pound magnet in the same position as when they were attracting, they then repel — ?"

Only after I conducted further experiments did I understand what was happening and that there was a repelling of the South pole of the smaller magnet when placed at the very end of the South pole of the 6-inch long magnet.

"... whenever there is a stronger magnetic field merging with a weaker magnetic field, the true polarity of the weaker magnetic field should be stated with caution."

36

E. Scientifically, this experiment proves that whenever there is a stronger magnetic field merging with a weaker magnetic field, the true polarity of the weaker magnetic field should be stated with caution. Similarly, sunspots' magnetic fields have been found to possess strengths of up to 500,000 gauss. With a low strength of tens-of-gauss measured during sunspot activity, the Sun's general magnetic field should be stated with caution. The Sun's general magnetic field will be considerably weaker than sunspot magnetic fields at any one point. However, because of the *total size* of the Sun's general magnetic field, such a field is *immensely stronger than all the sunspot fields combined*.

F. An additional experimental comparison follows: (Refer to Figures 36-F1 and 36-F2.)

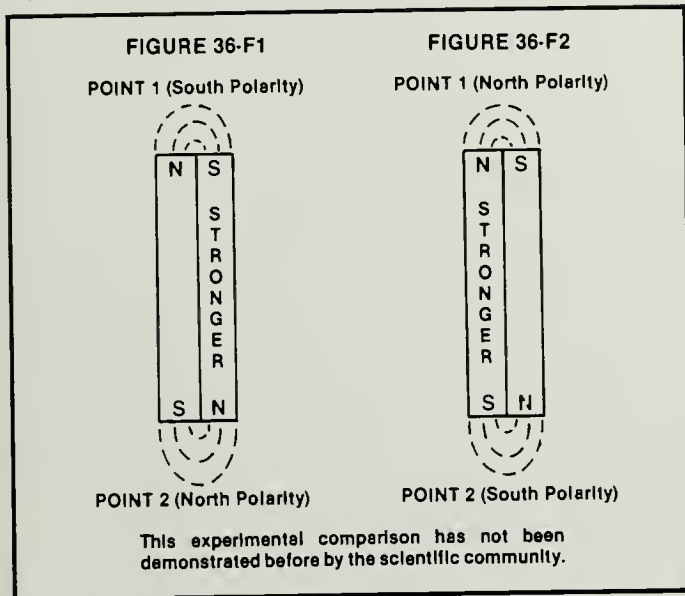

When two magnets are placed parallel, as in Figure 36-F1, they will have a weaker general polarity at points 1 and 2 (caused by the merging of the two fields) in the same manner as the magnet with the strongest field. If the strengths of the two magnets are reversed as in Figure 36-F2, the weaker general polarity at points 1 and 2 will reverse.

36

G. Consequently, if imaginary lines are drawn from the leading and following spots in the Northern Hemisphere, one will have a drawing of the Sun as depicted in Figure 36-G:

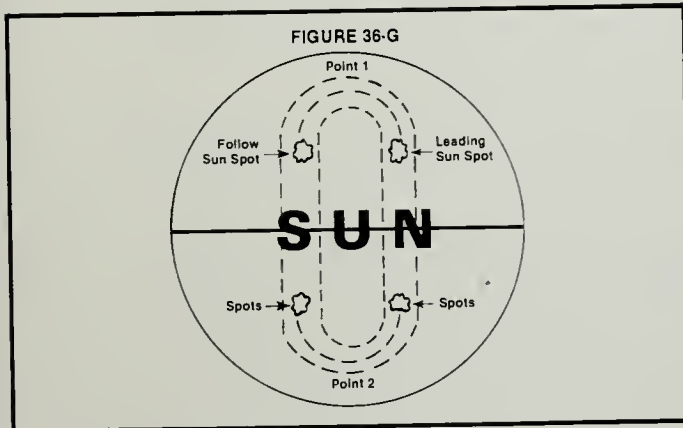

There will be a weaker general field of the sunspots at points 1 and 2 depending upon which magnetic field is strongest. If the poles reverse in polarity but maintain the strongest field, the weaker general field at points 1 and 2 will also reverse. If the polarity of the poles remain the same but the strength of the poles reverse in terms of which side is stronger, then the weaker general field at points 1 and 2 will also reverse.

36

H. Therefore, I have presented a sound scientific and factual argument that the polarity of the Sun's general magnetic field has not been studied by the Zeeman

Effect, but the general field of sunspot activity was studied instead.

QUESTION: Have you, the reader, Mastered what I have taught? Do not blindly accept what I teach, but question the "Facts" for yourself. Similarly, do not blindly accept what one was originally taught to "memorize" when one studied Astronomy.

I have questioned previously accepted concepts and the "Facts" have clearly convinced me that what I teach is indeed correct. Based upon these "Facts" combined with a "rigid format of Logic," you must decide for yourself what is "true" and what is "false." As one who values scientific precision, I urge you to discard what is "false" and adhere to what is "true"!

37. A. EXAMPLE: Consider the statement, "The Moon presently has no magnetic field, it is unlikely that Venus has a magnetic field, and Mars may have a very small magnetic field."

The above statement was proposed by scientifically-oriented individuals. As a scientist, I was astonished that anyone could seriously accept such a statement. I now understand that such individuals have been unjustly influenced by a teaching system which rewards memorization and penalizes serious questioning of statements which may currently be accepted as true.

37

B. Well over 100 years ago, Michael Faraday clearly demonstrated that **neutrality to a magnetic field does not exist!** The Facts known prior to my teachings clearly demonstrate that the Laws of Electromagnetic Induction apply to planets, stars, etc., *if there were any magnetic fields involved.* From my own experiments with magnets and the known Laws of Electromagnetic Induction, I was strongly predicting such astronomical results in 1967.

37

C. In 1967, while I was predicting that the Moon would be found to have a magnetic field, everyone else (whose work I read) was saying that the Moon did not or would not be found to have any magnetic field of any consequence. For example, after an analysis of the Explorer 35's results, it was concluded that if a permanent lunar field existed, its magnitude would be less than two gammas. The Moon was considered magnetically dead by the scientific community.

In contrast, I was so positive that the Moon would have a magnetic field — my attitude being based upon my experiments — that I wrote Dr. Robert R. Gilruth (the previous director of NASA) a letter on January 3, 1969 still predicting that the Moon would be found to have a magnetic field when the astronauts made their first landing on the Moon. *If my predicted results were not corroborated, then I would readily admit that my document of 1967 was wrong;* but if I was correct, then my comments should be given immediate attention. (See copy of my letter [37-C1] to Dr. Gilruth dated January 3, 1969 and the copy of Dr. Gilruth's letter [37-C2] to me dated January 21, 1969.)

3062 Pickell Drive
Mobile, Alabama 36605
January 3, 1969

Dr. Robert R. Gilruth, Director
NASA Manned Space Flight Center
Houston, Texas 77058

Dear Dr. Gilruth:

I have been advised by Mr. Ben James of Public Affairs that you could assist me in my endeavor.

Two years have passed since I wrote a Scientific Document on How Bodies Move in the Universe, and I have been unable to get any other scientist to prove or disprove my document!

Enclosed please find a list of fifty-six colleges that received a copy of my document at their Department Head of Physics and Department Head of Astronomy, where applicable. Very few even offered the courtesy of acknowledging that they had received my document, and even fewer made comment. (Please see attached)

Also enclosed you will note a copy of a letter from Huntsville Space Administration and National Science Foundation to which there has been no follow-up correspondence.

Also please note the enclosed copy of my Scientific Document and a scientific article which I had printed in the Mobile Press, December 22, 1968, at a cost of \$650.00.

On or about February of 1967, my patent attorney, Harold J. Birch, with the firm of Irons, Birch, Swindler, and McKie in Washington, D. C. arranged an appointment for me and approximately six (6) scientists at Houston Space Center for the purpose of expressing an opinion on my document. Unfortunately, I have since lost the names of these gentlemen. They were quite courteous but did not contribute a definite statement except to say that I may or may not be correct and that the burden of proof was on me. One of the scientists, whom I liked because he seemed to have an open mind for new opinions, kept a copy of my document.

I have made my livelihood by inventing since 1961 and I have always told my clients that I would let my creative ability speak for itself. Therefore, since the burden of proof is on me, I would again like to bring attention to a prediction that I made two years ago, that the moon's axis would be found to have an angle toward the earth in relation to its magnetic field. (See page 12 of my scientific document.)

Dr. Robert R. Gilruth
January 3, 1969
Page 2

My purpose is strictly scientific and any comments I have made and offered in my document and article are based on numerous costly experiments made and paid for by me, plus countless long hours of deep creative thinking. I humbly ask that the following experiment be made when the Astronauts make their first landing on the moon, which hopefully will be in the very near future. This experiment will let my ability, or lack of creative ability, speak for itself. If this prediction is not as I have stated, I will readily admit that my document and article are wrong, and that I have wasted my time, as well as that of others, to whom I would greatly owe an apology. However, if I am correct, I think it would be appropriate that my comments be given immediate attention.

My prediction for proof is as follows:

The moon will have a magnetic field located within 12 of its axis or already designated North and South Pole. However, what has been stated by scientists as the moon's North Pole will have a South Magnetic Pole within 12 of same. And what has been stated by scientists as the moon's South Pole will have a North Magnetic Pole within 12 of same. (This would have to be shown with a compass made with a high grade of alnico 5 material. Because a compass made of material that doesn't strongly retain its particular magnetic fields can have its polarity changed if quickly shoved into a stronger magnetic field.) If a magnetized pointer is used as a compass and one end is marked that points North on the Earth, it will point to the moon's South Pole, which will be the Moon's North Magnetic Pole.

Please inform me at your earliest convenience as to what I may expect in reference to my request and any scientific comments would be welcomed!

Sincerely,

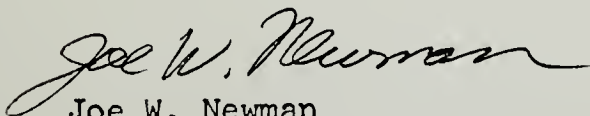

Joe W. Newman
3062 Pickell Drive
Mobile, Alabama 36605

Attachments



37-C2

NATIONAL AERONAUTICS AND SPACE ADMINISTRATION
MANNED SPACECRAFT CENTER
HOUSTON, TEXAS 77058

IN REPLY REFER TO: TA

JAN 21 1969

Mr. Joe W. Newman
3062 Pickell Drive
Mobile, Alabama 36605

Dear Mr. Newman:

Thank you for your interesting document on the space program. The magnetic field of the moon is an area we have worked on some in the past. The U. S. satellite, Explorer XXXV, as you probably know, went into orbit around the moon carrying a magnetometer. This instrument, as well as a similar instrument on the Russian lunar lander, Luna 9, showed that the magnetic field of the moon is very small. It is less than one thousandth of the earth's magnetic field and may be zero. Even if the field of the moon were zero, in a short time it would have collected a small magnetic field which would be transported from the sun via the solar wind. We think probably this is the nature of the present magnetic field of the moon based on the experiments which have been carried out so far.

We currently have plans for placing a very sensitive magnetometer on the surface of the moon in the second lunar landing. The payload for the first lunar landing has already been determined. The magnetometer will try to study the field of the moon in more detail and for a longer period of time in order to determine whether it is, as we suspect, controlled by the sun. The result of this experiment will be published in the scientific literature made available to the press as soon as it is available.

Thank you very much for your interest.

Sincerely,

Robert R. Gilruth
Director

³⁷
D. Since the Moon was considered magnetically dead, the first Apollo 11 landing was not even scheduled to carry a magnetometer. *However, on November 12, 1969, the scientific community was very excited and surprised when an instrument measured a permanent magnetic field of 38 gammas at the Apollo 12 landing site.* Then in February, 1970, the Apollo 14 crew measured a magnetic field of **43 gammas** and **103 gammas** at two different locations near their landing site which was 110 miles east of Apollo 12. During a time period around August 1, 1971, the Apollo 15 crew measured a magnetic field of **6 gammas** at their landing site. Then, in April, 1972, the Apollo 16 crew measured a surprisingly high magnetic field of **313 gammas** at their landing site. The Apollo 17 mission did not carry a magnetometer. [NOTE: A gamma is a unit of magnetic intensity, equal to 10^{-5} oersted.]

The magnetic field measurements obtained at the Apollo sites combined with the high magnetic remanence found in rock samples returned from all the Apollo sites, demonstrate that the Moon is magnetized in all visited regions.

³⁷
E. I strongly predicted these results **before** the first lunar landing, but these were **not** the results predicted by the scientific community before the first lunar landing.

³⁷
F. Because the direction and intensity of the Moon's magnetic field varies and is based upon measurements recorded in Space by satellites, some scientists have offered the hypothesis that the Moon's permanent field is only localized.

I do not consider this a correct scientific conclusion. Even the Earth's magnetic field is described "like the wanderings of a snail," and its intensity varies greatly over different mineral deposit areas. My experiments have scientifically demonstrated the complications of determining strength and polarity of a weak magnetic field at a distance from its source, as did the Russian Luna 10 and the U.S. Explorer 35 experiments conducted before the first manned Moon landing. The reader may find it interesting that *after* the measurements of the Moon's magnetic field were recorded, a new article stated: "No one predicted the magnitude of the Moon's magnetic field." I brought this news statement to the attention of one physicist and my original, strong prediction *before-the-fact*, and the physicist's reply was that "I had a 50-50 chance of guessing this Fact." **QUESTION:** Do you, the reader, believe that the Facts indicate I was only guessing?

³⁷
G. From my experiments, the laws of magnetic and electric fields, and the "Facts," I am certain that the Moon has a general magnetic field which is considerably weaker than the Earth's field. I am also certain that a magnetic field will be found at any other manned landings made on the Moon, Venus, or Mars.

³⁷
H. The mathematical statistics presented in Sections 33-E through 35-J certainly prove that I am correct since I assembled such statistics seven years *after* my original prediction.

38. A. Let's examine other current statements in Astronomy. The following information is quoted from the two books, *Astronomy* and *Frontiers of Astronomy* by eminent astronomer Fred Hoyle. [*Astronomy* is published by Rathbone Books, Ltd., London, 1962; *Frontiers of Astronomy* is published by New American Library, New York, 1964.] From *Astronomy*, page 260:

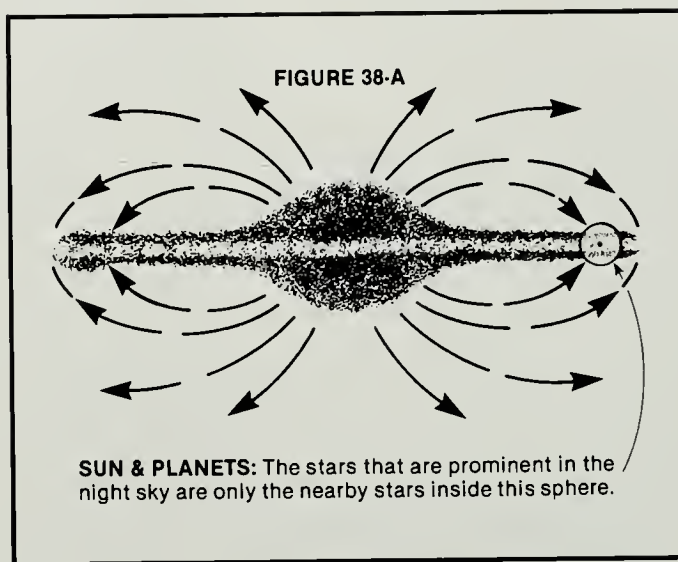
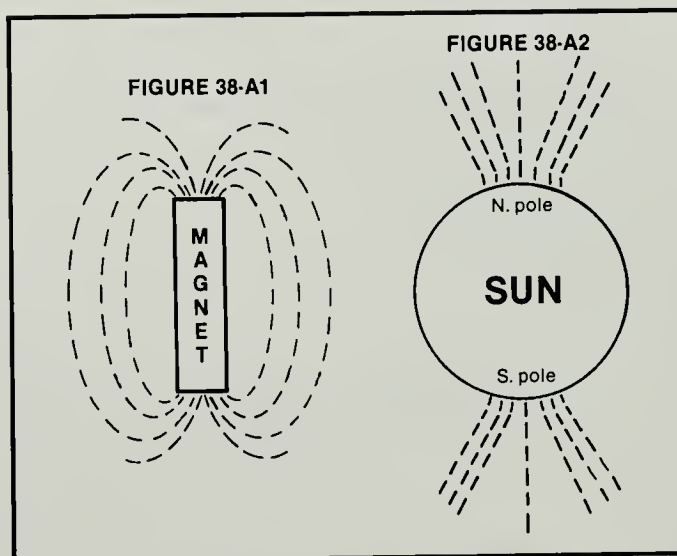

Figure 38-A is a "schematic representation of the magnetic field of a galaxy. Lines of force seem to be aligned mainly parallel to the galactic plane. It is strongly suspected that a magnetic field pervades our galaxy."



The fact that the Earth and Sun have magnetic fields is well known. However, quoting from Fred Hoyle's book, *Frontiers of Astronomy*, page 106: "The problems of the Sun's field is not as simple as that of an ordinary magnet." Figure 38-A1, "shows the pattern in which iron filings arrange themselves around an ordinary magnet."

“... a careful examination of the polar plumes of the corona suggests that the lines of force emerging from the poles of the Sun show the behavior indicated in Figure 38-A2. The lines of force apparently make a bee-line dead away from the Sun, and the farther they go the less indication there seems to be that they are ever going to curve round and join up with the lines of force from the other pole. *Where do these lines of force go to? This question raises a puzzle to which there is no agreed answer.*” (Emphasis added.)

38

B. To simply demonstrate the observations of Section 38-A, I conducted the following test:

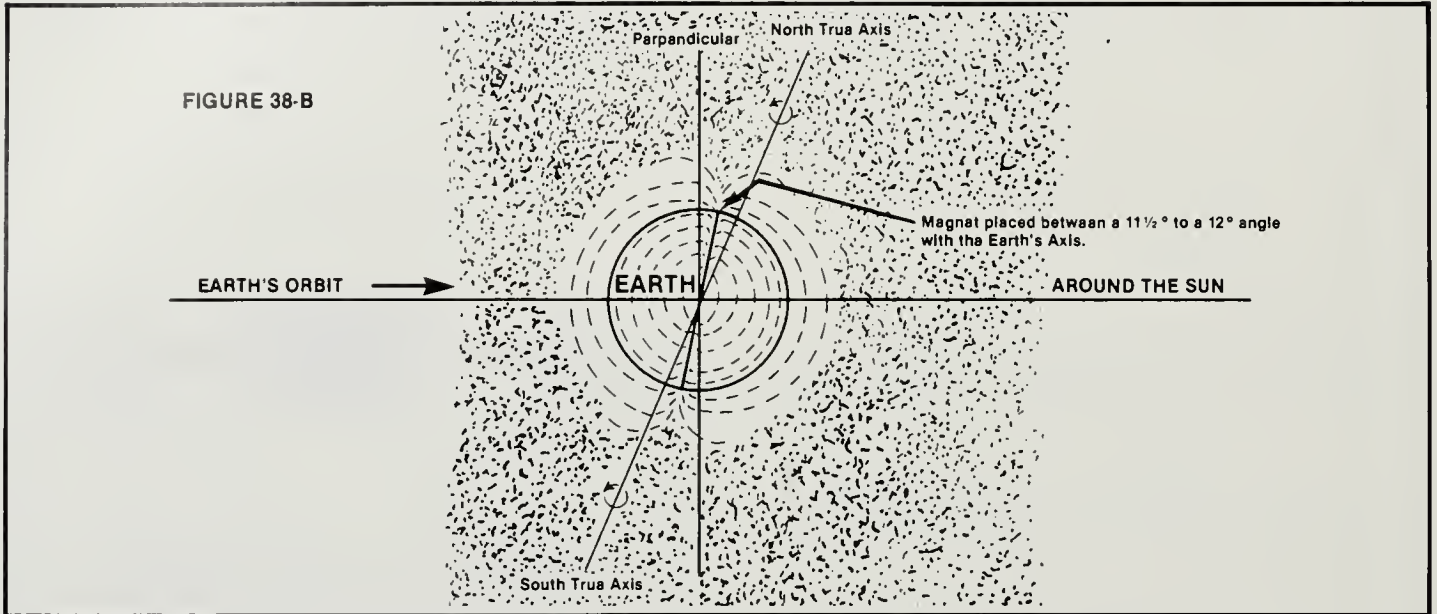

I scratched the drawing in Figure 38-B on a clear plastic rectangular pan (10½" wide by 17" long) and filled in the scratches with red paint so the image could be easily seen. Then I taped a small magnet (¾" long by 1/16" diameter) under the plastic pan as shown. I sprinkled the plastic pan with iron filings. When the plastic was physically tapped, the iron filings arranged themselves as shown. The iron filings not in the immediate vicinity of the scratched drawing were not aligned by the small magnet. It is easily seen that the magnetic lines of flux in Figure 38-B align as they do in Fred Hoyle's Figure 38-A1, but not as shown in Fred Hoyle's Figure 38-A2.

38

C. However, when the Figure 38-B experiment is physically moved to the vicinity of the equator of a large, 90-lb. magnet, the results are as follows:

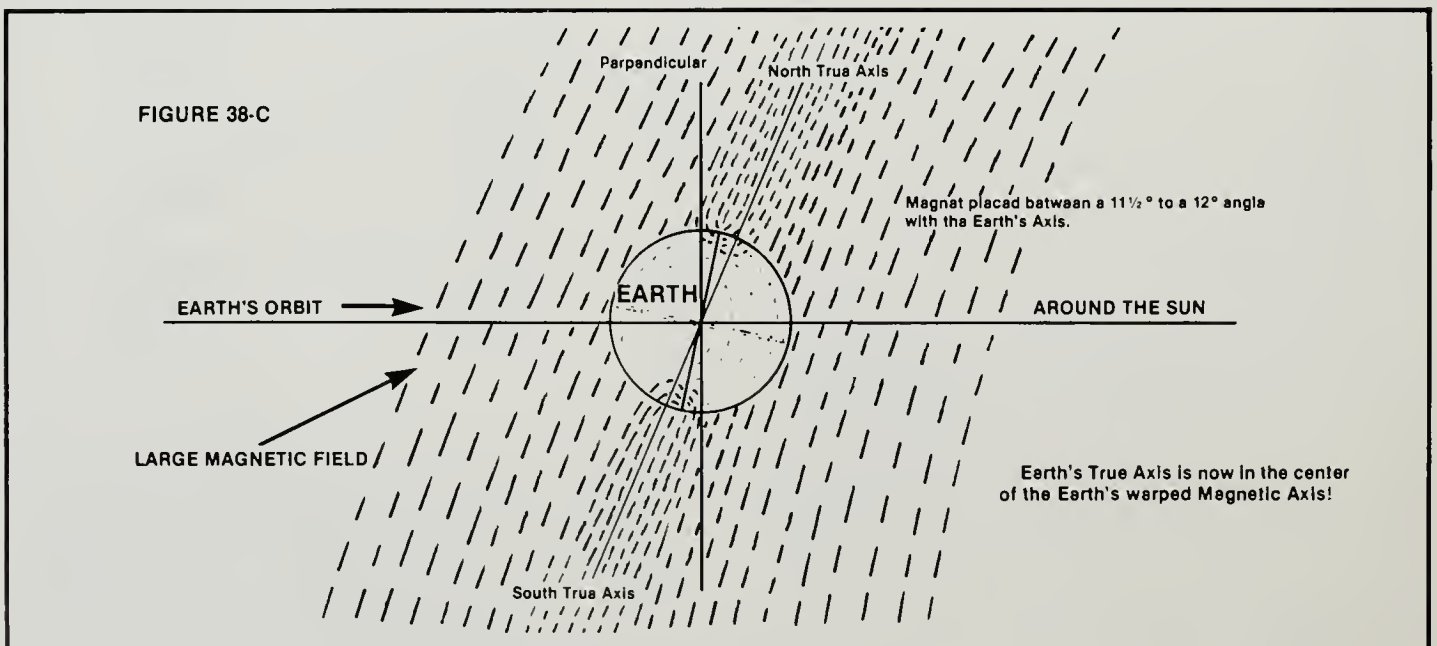

From Figure 38-C one can observe the following:

^{38-C}
(1) The magnetic field depicted in Figure 38-B is now immediately warped.

^{38-C}
(2) When the experiment is physically tapped, the iron filings on the scratched circle in Figure 38-B travel to the North and South poles or the magnetic equator as shown in Figure 38-C. (This effect varies depending upon the distance separating the larger and smaller magnetic sources.)

^{38-C}
(3) The iron filings not previously moved by the small magnet all align with the magnetic field of the large magnet. Such filings beautifully align with the iron filings in Figure 38-C and cause the Earth's true axis to be in the *center* of the Earth's warped magnetic axis. (Compare Figure 38-C to Figure 34-J.)

It is easily seen that the magnetic lines of flux in Figure 38-C do not align as they previously did in Figure 38-B, or as they do in Fred Hoyle's Figure 38-A1, but do align as shown in Fred Hoyle's Figure 38-A2, since they move directly *away* from the small magnet. Therefore, the question raised by the observation of the Sun's magnetic field shown in Fred Hoyle's drawing in Figure 38-A2 — upon which there previously was no agreed answer — is now answered. My simple experiment demonstrates that the Sun's magnetic field connects with a far larger magnetic field: *our galaxy's magnetic field* as shown in Fred Hoyle's Figure 38-A.

³⁸
D. The true depiction of our Sun's magnetic field should be shown as in Figure 38-A of our Galaxy's magnetic field. The polar plumes of the Sun's corona appear in Fred Hoyle's Figure 38-A2 simply because that area of the Sun has the strongest magnetic lines of force which contain strengths that dominate the Sun's polar plumes. Examine the two, top and bottom center arrows of Figure 38-A and compare those to the ones in Figure 38-A2. You will see that such effects are a duplicate of one another. (See Figure 38-D.)

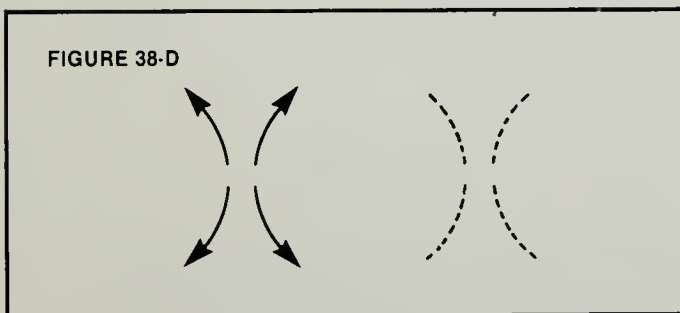

³⁸
E. The results of Figure 38-A combined with my teachings and the known Laws of Electromagnetic Induction clearly demonstrate that our Sun and all of its planets are affected and governed by the electromagnetic effect since:

- (1) **gravity represents the "Unequaling Effect" of the Unobvious Effects of the electromagnetic composition of all Matter and,**
- (2) **magnetism and electric charges are composed of the same gyroscopic-action-particle that is the basic building entity of all Matter.**

39. Let's examine my explanations for other astronomical statements:

³⁹
A. Astronomy teaches that the Moon has a slow rotation and that at all times it keeps the same hemisphere turned towards Earth.

³⁹
B. Popular Explanation: "In the remote past, the Moon rotated more rapidly, but the drag of the tides induced within its once-plastic body by the more massive Earth, robbed the Moon of its spin. Moreover, the Earth's gravitational pull upon a *slight bulge on the side of the Moon facing the Earth* is probably responsible for its continually facing the Earth."

³⁹
C. On August 4, 1971, a scientific finding was published that the Moon is lopsided with the bulge on its backside. (This contradicts the hypothetical "popular statement.")

"I therefore concluded that the Moon keeps the same face towards the Earth because the Moon is close to the Earth and the magnetic and electrical alignment of the Moon's and Earth's Fields of Force are stronger than the centrifugal force."

³⁹
D. From experiments I conducted in 1966 — with small magnets covered with varying amounts of clay and fixed where they could orbit around a larger magnet — I observed the following results:

The smaller magnet was observed to make an elliptical orbit; it was observed to spin in the direction it was traveling; and it was observed that when the orbital path of the smaller magnet around the larger magnet reduced, the speed of its motion around the larger magnet increased. It was also observed that *when the smaller magnet approached the larger magnet, it would begin to maintain the same face towards the larger magnet.* This result would cease if the orbit became extremely elliptical which caused the smaller magnet to spin erratically.

³⁹
E. I therefore concluded that the Moon keeps the same face towards the Earth because the Moon is close to the Earth and the magnetic and electrical alignment of the Moon's and Earth's Fields of Force are *stronger than the centrifugal force.* (If the Moon moved farther from the Earth, then the Moon would start spinning.)

40. Based upon my experiments and the Laws of Magnetic and Electrical Fields, I made the following statement in 1967:

40
A. "It would be a violation of the proven laws of magnetism and electricity **for a body orbiting the Sun not to continuously attempt to align its magnetic lines of flux with the magnetic lines of flux of the Sun.** As a result, the orbiting body's **degree of angle, speed, elliptical orbit, and the rotation on its axis will vary** as the distance varies between the orbiting body and the Sun."

40
B. In October, 1970, I read the following scientific information:

"Analysis of data by Stoyka at Paris Observatory has revealed accelerations and retardations of the Earth's rotation over the very short period of about one year.

"The last word has not yet been said on this matter and there is still much to be done. Astronomers, though, justifiably worry about it."

40
C. This is precisely what I predicted in 1967 via statement 40-A: "... and rotation on its axis will vary ..."

40
D. In the December 13, 1968 issue of *Time Magazine*, page 54, I read the following scientific information:

"Instead of spinning smoothly, the Earth wobbles on its axis. By sighting telescopes on distant fixed stars and carefully measuring their apparent movement, scientists have determined that the North and South poles — the points at which the imaginary axis of rotation pierces the Earth's surface — are continually on the move. Over the course of a year, they wander about the polar regions in roughly circular paths about 50 ft. in diameter. The cause of the erratic wobbling motion has long been a geophysical mystery."

40
E. Again, this is exactly what I predicted in 1967 via statement 40-A: "... degree of angle ... will vary ..."

40
F. I also read this scientific information:

"The Magnetic Poles wander, proved also in 1912 in the South Pole by observations of several months, the pole wandered along the arc of a five-kilometer circle."

There was no reason or explanation provided for such "wandering."

40
G. Once again these results are exactly what I predicted in 1967 via statement 40-A: "... a body orbiting the Sun ... (will) ... continuously try to align its

magnetic lines of flux with the magnetic lines of flux of the Sun."

40
H. These scientific observations which I read and my comments in Sections 40-A through 40-G coincide exactly with the results described in Figure 34-J along with the mathematical proofs in Sections 34-B through 34-H that the Earth's true axis is generated by the Earth's magnetic axis. The scientific observations of Section 40-D and Section 40-F demonstrate that the Earth's true axis traces a small circle which is the result of the larger circle traced by the Earth's magnetic axis in the period of one year!

40
I. It is doubtful that the circles described in Section 40-D or Section 40-F will be closed circles. Such circles would be open because the motions of the Sun as it orbits within our Galaxy — combined with the forward motion of our Galaxy — prevents the Earth from tracing the exact same orbit as the previous year. (See Figure 40-1.) Therefore, by conducting measurements on distant stars one will observe similar circles as described in Section 40-D and Section 40-F.

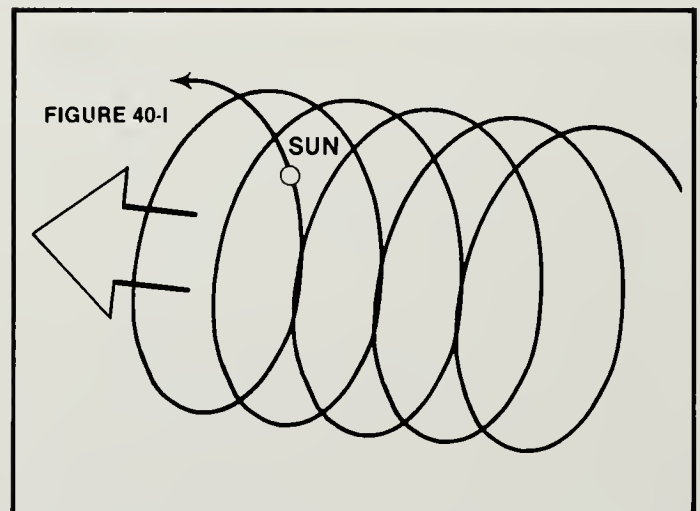

41. A. Astronomy teaches that the planet Pluto has the greatest inclination of any planetary orbit. All other planets move in orbits that are only slightly inclined to the ecliptic, *i.e.*, the Earth's orbit around the Sun. The exception to the rule is Pluto which lies on a plane about 17 degrees with the ecliptic. (See Figure 41-A.)

41
B. Popular explanation for Pluto's inclination: "Pluto may be a lost satellite of Neptune."

41
C. My experiments have shown me that the further from the *source* of a magnetic and electrical field of force — when that *source* is engrossed in a larger magnetic and electrical field of force — the greater the warpage of the lines of forces of that *source*.

41
D. This warpage is generated by the inertia of the *source* wanting to carry that source in a straight line as it orbits another source.

FIGURE 41-A

THE SUN'S TRUE AXIS IS A RESULT OF THE SUN'S MAGNETIC AXIS (AS EARLIER DEPICTED FOR THE EARTH) ALIGNING WITH THE CURVATURE OF THE GALACTIC MAGNETIC AND ELECTRICAL FIELDS OF FORCE.

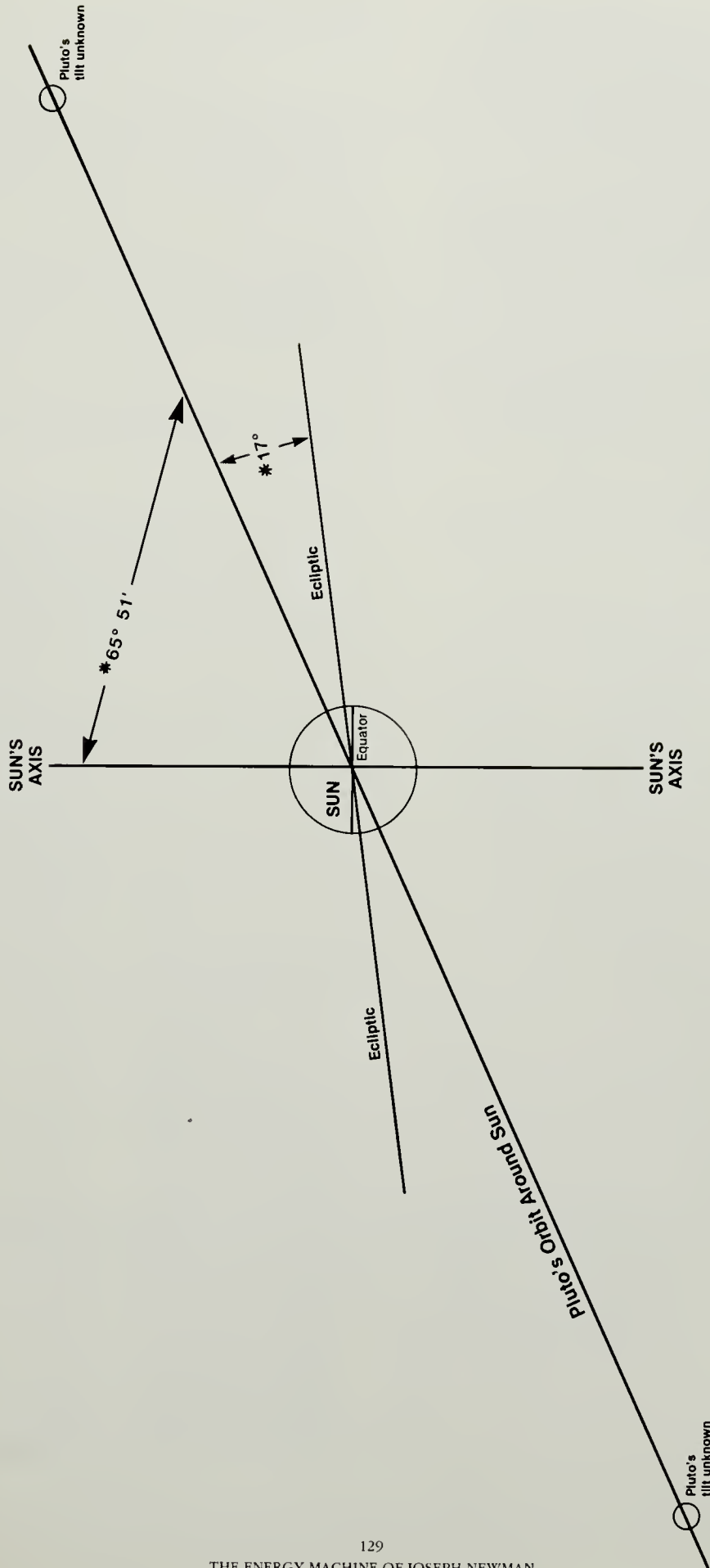

Compare the degree of the angle between Pluto's Orbit and the Sun's True Axis to the degree of the angle between the Earth's Orbit and the Earth's True Axis. (See Figure 34-J.) They are equivalent! This indicates a mathematical relationship throughout the Solar System caused by each smaller body aligning itself with the larger curvature of the Magnetic and Electric lines of force of the larger body which the smaller body orbits.

* Approximate figures

⁴¹
E. Pluto is 3,670,000,000 miles from the Sun (the *source*) or 39.5 times the distance of the Earth from the Sun. Therefore, due to the inertia of the Sun, the Sun's magnetic and electrical fields of force begin to warp as they continuously try to align with our Galaxy's magnetic and electrical fields of force.

⁴¹
F. Because of confidence in the veracity of my experiments, I searched years ago for mathematical proof that Pluto's magnetic and electrical fields of force do in fact align with the Sun's magnetic and electrical fields of force.

⁴¹
G. An additional mathematical argument is now presented! The degree of angle of Pluto's orbit to the true axis of the Sun (approximately 65°, 51') closely equals the degree of angle of the Earth's orbit to its true axis (approximately 66°, 53').

⁴¹
H. The mathematical odds of the probability of these figures "happening by accident" are 29,160,000 to 1, *i.e.*, 5,400 X 5,400.

⁴¹
I. I have already presented strong proof that the Earth's orbit and true axis are the result of the Earth's magnetic axis aligning with the curvature of the Sun's magnetic and electrical fields of force.

⁴¹
J. The same mathematical relationship has occurred again! This indicates to me that the same mathematical relationship operates throughout the Solar System! Such is the case because every smaller body aligns with the larger curvature of the magnetic and electrical lines of force of the larger body which the smaller body orbits.

42. A. Further experimental proof of my Theory follows:

The following results were observed from the experiment pictured in Figure 42-A:

⁴²
B. When the small magnet was maintained in a flat position in the small dish, it would always travel to the magnetic equator of the larger magnet regardless of where the small magnet was originally placed in the pan of water.

⁴²
C. When the small magnet was tilted a small amount with one end upward, the small magnet would travel slightly North or South of the large magnetic equator, depending upon which end of the small magnet was actually tilted.

⁴²
D. When the small magnet was tilted even more, it would travel even further North or South of the large magnetic equator.

⁴²
E. When the plastic pan of water was lowered too close to the large magnet, the small magnet would start to tilt at an extreme angle and would move further North or South of the large magnet's equator. This process would continue until the small magnet was pulled under the water which would cause the small dish to sink.

⁴²
F. As a result, this experiment explains why all the planets orbit in the vicinity of the Sun's magnetic equator in varying degrees of angle due to electromagnetic alignment and the warpage of the Sun's electromagnetic field. This experiment also explains why most stars orbit in a galactic plane. [I also predict that galaxies also orbit within the plane of their respective Central Entity. (See Section 52-M.)]

⁴²
G. This experiment also provides an explanation of why sunspots always travel to the Sun's equator and

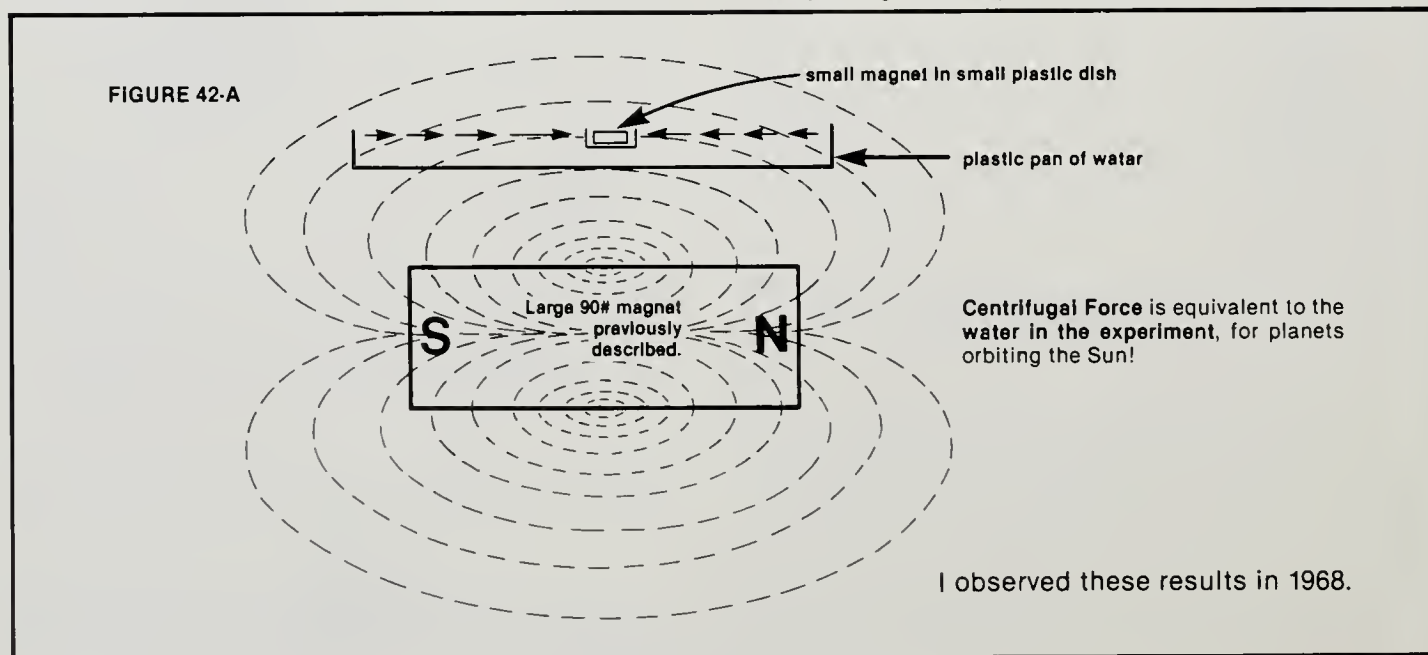

Simulation of the Sun's Magnetic and Electrical Lines of Force only. (Such lines of force emanate from the Sun in a mathematical order and are warped differently as the distance varies.) **The Planets' degree of angle of their orbit to the Sun's True Axis and their tilts to their own orbit are controlled by their respective Magnetic and Electrical Lines of Force aligning with the Sun's Magnetic and Electrical Lines of Force!** Such action is exactly that which was demonstrated and described for the Moon in Figure 34-J.

This Figure depicts the planets' degree of Angle of Orbit to the Sun's Axis (and above the Sun's Equator) as well as their Degree of Tilt of Axis to their respective orbits which align with the curvature of the Sun's Magnetic and Electrical Lines of Force. The Sun's Lines of Force are also warped by the spinning of the Sun, but this does not alter how the magnetic and electrical fields align with one another!

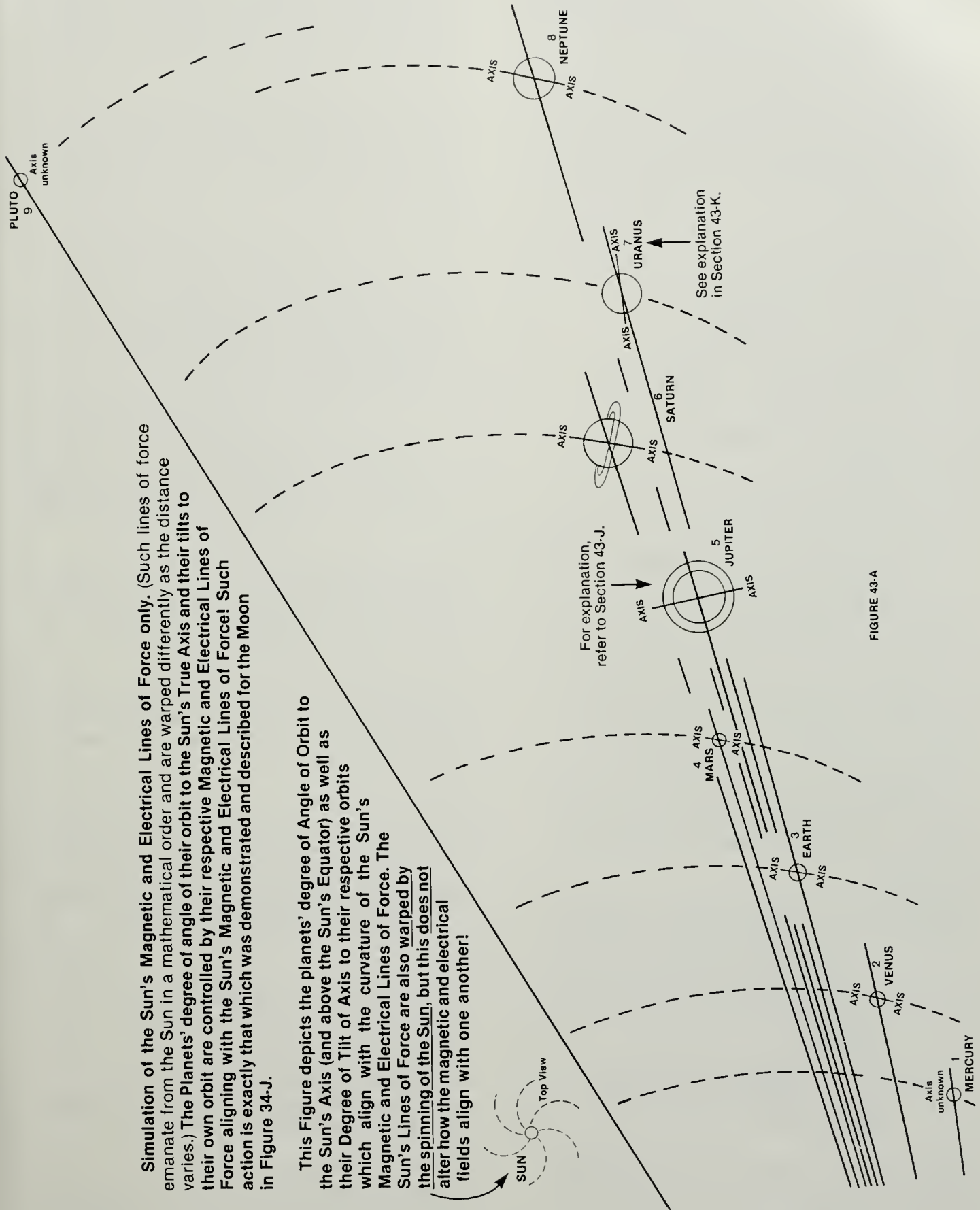

FIGURE 43-A

why they are seldom found more than 40° North or South of the equator. Like the small magnet in experiment 42-A, the sunspots are probably pulled under the Sun's surface if they travel too close to the magnetic poles of the Sun.

43. A. Astronomy teaches that seven of the planets orbiting the Sun have particular tilts to the perpendicular of their orbits, and two of the planets' tilts are unknown. (See Figure 43-A.)

The tilts of the planets and their distances from the Sun are as follows:

1. **MERCURY, tilt unknown**
36 million miles from the Sun
2. **VENUS, tilt 25°**
67 million miles from the Sun
3. **EARTH, tilt 23½°**
93 million miles from the Sun
4. **MARS, tilt 25°**
142 million miles from the Sun
5. **JUPITER, tilt 3°**
484 million miles from the Sun
6. **SATURN, tilt 27°**
887 million miles from the Sun
7. **URANUS, tilt 82°**
1,787 million miles from the Sun
8. **NEPTUNE, tilt 29°**
2,797 million miles from the Sun
9. **PLUTO, tilt unknown**
3,670 million miles from the Sun

43 B. No reason is provided by currently accepted teaching which explains the above statistics other than the statement that "it just exists this way."

43 C. All the proof that I have presented to this point indicates to me that all planetary motion in our Solar System is controlled by the Sun's magnetic and electrical fields of force.

43 D. Figure 43-A and the earlier Figure 34-J represent additional proof that planetary motion is controlled by the Sun's magnetic and electrical fields of force.

43 E. In Figure 43-A, the nine planets are shown in their particular orbits with their respective degree of axis tilt to their orbit.

43 F. In Figure 43-A, the dash lines are intended to simulate the curvature of the Sun's magnetic and electrical lines of force.

43 G. Because there is progressively a greater difference of millions of miles between each planet (refer to Section 43-A), the curvature of the Sun's lines of force will have greater and greater arcs.

43 H. It is obvious that each of the following planets — Venus, Earth, Mars, Saturn, and Neptune — is aligning its true axis (which is the result of its magnetic axis) to the curvature of the Sun's magnetic and electrical lines of force. (See Figure 43-A.)

43 I. It is also obvious that the degree of planetary axis tilt becomes progressively greater as the distance from the Sun becomes greater. Venus is an exception and therefore deserves verification due to its continuous cloud covering. Jupiter is an exception and is discussed next.

43 J. Jupiter is so voluminous — it could accommodate all the other planets within its perimeter — and has such a powerful magnetic and electrical field of force, that it nearly cuts the curvature of the Sun's lines of force into a straight line. (See Figure 43-J1.)

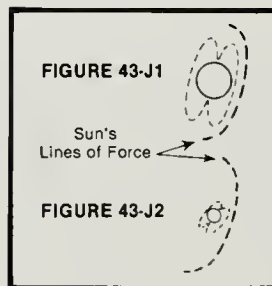

The average distance of Jupiter's most remote satellites is 23,660,000 miles. Therefore, the tilt of Jupiter's axis to the perpendicular of its orbit is only 3 degrees. A smaller electromagnetic field would cause Jupiter to tilt more, as it does with the smaller planets. (See Figure 43-J2.)

43 K. Uranus is diamagnetic in nature and aligns perpendicular to the Sun's magnetic and electrical lines of force. (The nature of diamagnetic materials was originally proven by Michael Faraday.)

43 L. Astronomy teaches that all of the planets are above the Sun's equator on one side of their respective orbits and below the Sun's equator on the other side of their respective orbits.

43 M. There is no reason provided in current astronomy teachings except to say that "it just exists this way."

"... all planetary motion in our Solar System is controlled by the Sun's magnetic and electrical fields of force."

43 N. Figure 43-A shows the planets *above* the Sun's equator; the planets hold their same tilts when they travel to the other side of the Sun, but are then *below* the Sun's equator.

43 O. The reason for such "tilt maintenance" is the same reason provided for the Moon's tilt in its orbital relation to the Earth's equator. (See Figure 34-J.)

43 P. Examine my Theory of the Universe as I stated in Section 33-D. If you consider all the factual information that I have presented throughout this entire Book, *the Facts verify my Theory!*

43

Q. The Facts I have consistently presented are certainly more scientifically sound than current astronomical teachings which say that "all bodies in the Universe have particular angles, orbits, and distances from one another simply because they 'landed' that way." At one time, gravity was called an "invisible entity" which was not clearly understood. It should be clear by now that gravity simply represents the "Unequaling Effect" of the Unobvious Electromagnetic (gyroscopic-action-entity) composition of all Matter.

43

R. The following information should be taken seriously and "Mastered":

44. A. I am extremely indebted to Dr. Robert E. Smith, Chief, Orbital and Space Environment Branch, Marshall Space Flight Center, Alabama, for having the scientific insight to recognize a correlation between my work and the work accomplished by Ellsworth Huntington over fifty years ago.

44

B. On June 22, 1976 (see Section 33-A), Dr. Smith sent copies of Ellsworth Huntington's work to me with the comment that "it supplements and complements your work."

44

C. Without Dr. Smith's scientific insight, I am very doubtful that I would have ever known of this information since it appears that Ellsworth Huntington's work can only be obtained from the Library of Congress.

44

D. After reading Huntington's work, I was amazed that it had lain dormant for all these years (except for the recognition of its significance by such insightful individuals as Dr. Smith), and I was very excited because the reader will see that Ellsworth Huntington's work complements my work *exactly*. However, after pondering the results of my and Huntington's work, as well as conducting additional experiments, the scientific results I have obtained give me reason to have concern since it appears that a possible catastrophe may lie in the Earth's immediate future. [But I must stress that there is no problem which cannot be solved if the essence of the problem is properly understood!]

44

E. The dedicated scientific work of Ellsworth Huntington *proves* that sunspot activity is principally caused by the planets. The question asked by Huntington was whether such sunspot activity was caused by a gravitational, electrical, or some other effect. Huntington believed that it was probably an electrical effect. (See pages 244, 245, and 284 of *Earth and Sun* by Ellsworth Huntington.)

44

F. I will proceed to combine Huntington's scientific findings with mine: Sections 33 through 43-P of this Book provide exacting, scientific evidence that the

planets' tilts and orbits are governed by electromagnetic fields of force.

44

G. On the bottom of page 244 and the top of page 245 of *Earth and Sun*, Huntington states that sometimes the planets have a negative effect upon sunspot activity and at other times a positive effect. This was very perplexing to Huntington since there was no way such results could be explained by a gravitational effect. But such sunspot effects may be explained by an electrical hypothesis.

44

H. In accord with such an electrical hypothesis, I conducted the following experiment:

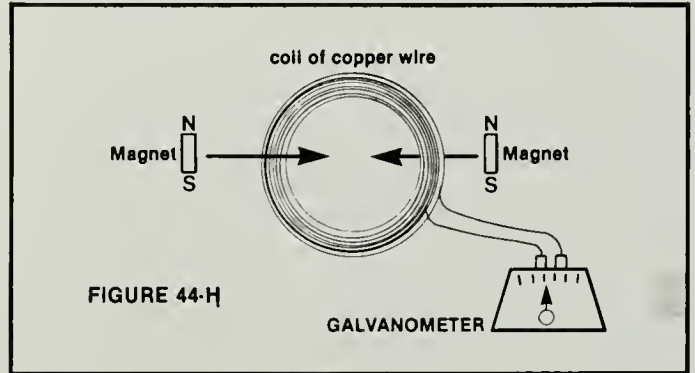

FIGURE 44-H

44-H

(1) If the magnets were singly moved, a given current was recorded on the galvanometer.

44-H

(2) A considerably smaller current was recorded on the galvanometer when the magnets were moved simultaneously at the same speed in different directions as shown in Figure 44-H. (Current is now being induced in two different directions and tends to cancel the net effect.)

44-H

(3) This simple experiment satisfies Huntington's concern re sunspots described in Section 44-G, since this concern can be duplicated with the Laws of Electromagnetic Induction.

44

I. Throughout his book *Earth and Sun*, Huntington indicates that when the planets of our Solar System are in alignment with one another, they increase the quantity of sunspots. As a result of this observation, I conducted the following experiment:

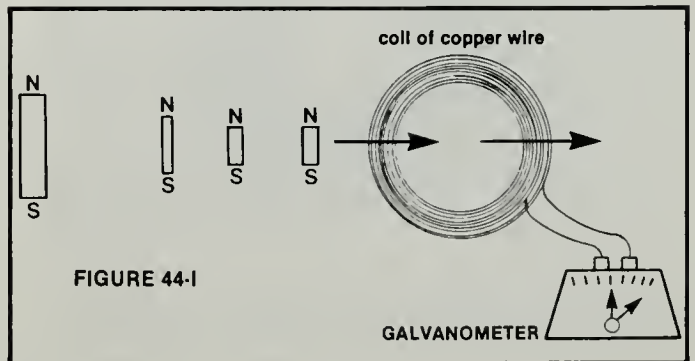

FIGURE 44-I

44-I

(1) The greater the number of magnets aligned as shown in Figure 44-I, the greater the amount of current that was recorded on the galvanometer when the magnets were moved as shown. When the magnets reached the second arrow and continued on, the current reversed.

44-I

(2) If the largest magnet moved alone, then less current was generated than if one additional magnet was moved in alignment with it.

44-I

(3) This experiment satisfies Huntington's observation in Section 44-I since that observation is also duplicated by the Laws of Electromagnetic Induction.

44

J. On pages 278-281 of *Earth and Sun*, Huntington states that another observed relationship which puzzled him was that sunspot activity varied as a planet was North or South of the Sun's equator. This observation is also explained by my experiments in Section 44-H and 44-I. Every time the direction of movement or polarity direction changes, an electromagnetic induction change can be expected in accordance with the Laws of Electromagnetic Induction. (See Section 44-M.)

44

K. On page 225, bottom of page 245, and pages 246 and 247 of *Earth and Sun*, Huntington indicates that there is a relationship of sunspot activity to a planet's eccentricity of orbit.

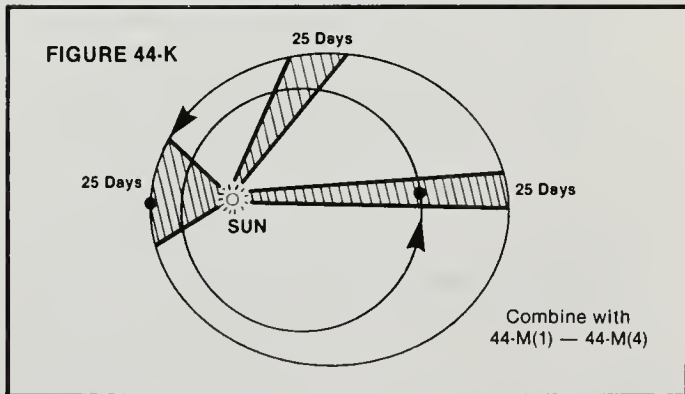

44-K

(1) I then simply applied Kepler's Second Law of Planetary Motion which states that "the radius vector would cover equal areas in equal time."

44-K

(2) Consequently, the difference in the rate of speed of orbit velocity for all the planets varies continuously. (See Figure 44-K.)

44-K

(3) In accordance with the Laws of Electromagnetic Induction, a continuous change in induction can be expected.

44-K

(4) However, remember that both the direction of movement and polarity being moved through are pertinent in terms of whether the change is

in harmony (giving a total increase in sunspots) or not in harmony (tending to cancel out sunspots). [Refer to my experiment in Sections 44-H, 44-I, and Figure 44-M.]

44

L. The average sunspot cycle is 11.13 years. However, as Huntington states in *Earth and Sun*, (page 253), sunspot maxima had ranged from 7.3 to 17.1 years.

44

M. With respect to the Laws of Electromagnetic Induction, it is an intriguing test of logic to anticipate the resulting force (or effect) of a planet (and its accompanying electromagnetic field) moving through the Sun's electromagnetic field in a complicated manner.

44-M

(1) The planet moves in an opposite direction through the Sun's electromagnetic field when the planet is on one side of the Sun in contrast to when the planet is on the other side of the Sun.

44-M

(2) While on one side of the Sun, the planet moves down from the North pole to the South pole. On the other side of the Sun, the planet moves up from the South pole to the North pole. In both cases, the planet goes into opposite sunspot polarity each time this occurs! The Sun rotates every 28 days sweeping this changing induction effect into the Earth and the other planets.

44-M

(3) The planet also changes its speed through the Sun's electromagnetic field when the planet is at its farthest and closest points from the Sun.

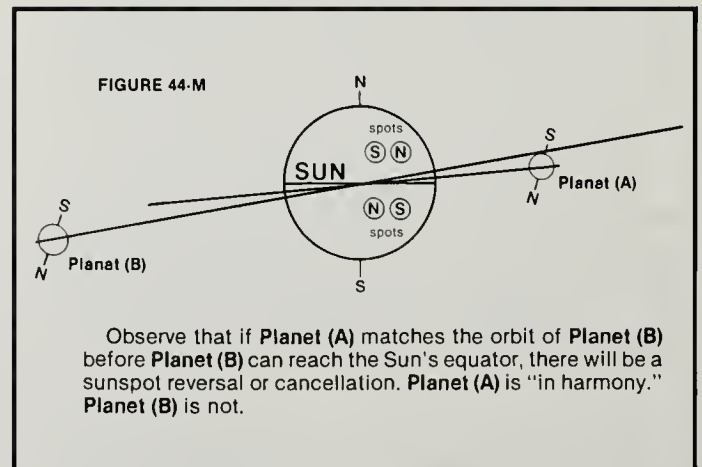

44-M

(4) Each planet crosses the Sun's equator twice and reaches two different extreme distances from the Sun during one planetary orbit of the Sun. (See Figure 44-M.)

Therefore, considering Section 44-K (4) and Section 44-M (1)-(3) and then applying the electromagnetic induction effect, one would consider these four points [44-M (1)-(4)] the most important for determining the average net effect.

⁴⁴
N. On the bottom of page 283 of *Earth and Sun*, Huntington states that he is not implying that the energy emitted from sunspots is derived from the planets, but that the planets act as a catalyst to cause the release of energy that is continuously present in the Sun, *i.e.*, similar to a "trigger mechanism" used in an explosion.

^{44-N}
 (1) I agree with this statement completely.

^{44-N}
 (2) **The Sun is Matter (electromagnetic energy), and the Matter is continuously converted into electromagnetic energy of one form or another. When triggered by electromagnetic induction, the Sun apparently accelerates its conversion of Matter into electromagnetic energy. (See Figure 44-O.)**

^{44-N}
 (3) **The sunspots and planets are behaving in accordance with the known Laws of Electromagnetic Induction.**

^{44-N}
 (4) **Sunspot reversal is caused by the sum of the total effect of all the planets in terms of whether the resultant, dominating, electromagnetic induction force is above or below the Sun's equator. As the planets continuously vary in their alignment, it is obvious that the resultant, dominating, electromagnetic induction force will also vary as it occurs throughout the observed sunspot cycle.**

⁴⁴
O. Observe Figures 44-Oa and 44-Ob which are depicted below:

^{44-O}
 (1) **In Figure 44-Oa, the electromagnetic output of the Sun appears orderly.**

^{44-O}
 (2) **In Figure 44-Ob, the electromagnetic output of the Sun appears explosive and, therefore, potentially hazardous with corresponding effects in-**

duced into the orbiting planets. Imagine this effect greatly increased.

^{44-O}
 (3) **QUESTION: What results can be expected when all the planets from Saturn to the Sun become perfectly aligned while at their closest respective points to the Sun?**

^{44-O}
 (4) **Present scientific evidence indicates that, in the past, the Earth's magnetic field has reversed and has been located in other areas. Moreover, there is also evidence that the true axis has also been located at other points upon the Earth.**
QUESTION: What event(s) caused these changes?

^{44-O}
 (5) **All the evidence I have gathered indicates that if the Earth's magnetic field reversed, the Earth would then try to turn upside-down to again align with the Sun's field. Such an event would cause earthquakes, volcanic eruptions, tidal waves, and atmospheric storms that would be disastrous to most life on Earth. Even lesser stresses placed upon the Earth can be dangerous.**

⁴⁴
P. *As the planets affect the Sun (and the Sun affects the planets), so does the Sun and other stars in our Galaxy affect the energy force around which they orbit!* Moreover, this central galactic energy source also affects the Sun and other stars in our Galaxy. Fortunately, because there are so many stars in our Galaxy, the mathematical odds against a dangerous stellar alignment are in our favor. **However, the evidence presented does warrant an immediate and extensive investigation to ensure that such an alignment will not surprise us!** The Universe does not "owe" us an advance warning of such potentially catastrophic stellar alignment. It is up to us to use our intellectual abilities to determine accurately if such a threat may exist and to take appropriate measures to ensure the durable survival of our Species.

FIGURE 44-Oa



1. Corone, May 18, 1901, near time of minimum sunspot activity. Charecteristic sunspot minimum with short polar brushes and long aquatorial streamers.

FIGURE 44-Ob



2. Corone, Aug. 30, 1905, near time of maximum sunspot activity. The circular corone characteristic of e sunepot-maximum period and tha long aquatorial streamers which give it its typical form are here visible.

45. The result of the Pioneer 10 passage by Jupiter is stated to have shown that the polarity of Jupiter's magnetic field in relation to axis spin is opposite to that of Earth's.

45
A. I strongly challenge this statement. Jupiter has 13 orbiting moons, and their magnetic poles will be opposite to Jupiter's and to the Earth's.

45
B. The orbital period of these moons varies from 12 hours to 2 years. The four largest moons (which rival Mercury and Mars in size), all orbit Jupiter in a short period of time:

Jupiter's Moon	Orbit Time	Average Distance From Jupiter
IO	1.7691 days	422,000 miles
EUROPA	3.5512 days	671,000 miles
GANYMEDE	7.1546 days	1,100,000 miles
CALLISTO	16.6890 days	1,880,000 miles

45
C. Other results of the Pioneer 10 voyage state that the planet Jupiter generates a powerful and complex magnetic field.

45
D. Jupiter's magnetic field is complex since all of its moons have magnetic fields which are the reverse of Jupiter's magnetic field. These reverse lunar magnetic

tions. For example, both probes encountered gusts of electrons of Jovian origin which were as much as 140 million miles from the planet. Jupiter generates a powerful magnetic field which occasionally accelerates particles to almost the speed of light and then "squirts" such particles great distances into the inner solar system. [My comparison: This same effect is observed from solar flares associated with sunspots, except greatly multiplied.]

45
H. The electromagnetic induction effect of the moons upon Jupiter is further evidenced by the fact that spots appear and disappear on Jupiter's surface in the space of a few days or months. [My comparison: This same description describes sunspots appearing and disappearing.]

45
I. Jupiter's Red Spot also shows a variance. It varies in color from an intense brick-red to a faint grey. At times it has lost all color and has become invisible. It is very likely that electromagnetic induction from Jupiter's moons also affects the Red Spot.

45
J. Other results from Pioneer 10 and 11 state that Jupiter is enveloped in a huge, quivering magnetic bubble at least ten million miles in diameter. The total magnetic force or movement of its magnetosphere has been estimated to be about 20,000 times that of Earth's.

"Jupiter's magnetic field is even more complex because its moons have a similar electromagnetic induction effect upon Jupiter as (I have shown) the planets have upon the Sun."

fields were encountered during the passage of Pioneer 10 as evidenced by the findings of Section 45-E below.

45
E. As Pioneer 10 and 11 crossed the orbits of the major Jovian moons, their equipment detected an interesting phenomenon: there was a distinct drop in particle flux at each orbital crossing. It appears that the large satellites literally "carve holes" in the trapped radiation belts by absorbing large quantities of radiation during every ten-hour rotation of Jupiter *and of Jupiter's field lines* on which the particles mirror back and forth. It is obvious to me and it should be obvious to the reader that such results are caused by the electromagnetic field of the moons of Jupiter which trap or repel this radiation.

45
F. Jupiter's magnetic field is even more complex because its moons have a similar electromagnetic induction effect upon Jupiter as (I have shown) the planets have upon the Sun.

45
G. Such an electromagnetic induction effect is evidenced by the statement that Pioneer 10 and 11 made findings that have raised new and baffling ques-

45
K. Considering FACT 45-J, it would be a complete violation of the proven Laws of Electromagnetic Induction for Jupiter's magnetic field polarity to be the reverse of Earth's. I have presented sound scientific evidence that Jupiter (as well as the other planets) has an electromagnetic field which merges with the Sun's and that all planets will take the path of least resistance. Such a path would be one which is aligned with the Sun's field and not one which generates opposing fields of force. Because of the great diameter of Jupiter's electromagnetic field, there would be a torque placed at both ends of Jupiter's axis that should be phenomenal. Such a force would cause Jupiter to turn upside-down or move away from the Sun. Jupiter behaves like a gyroscope, and with such a force imposed upon its axis it would most certainly move at right angles to that force. Each time that Jupiter travels from the North of the Sun's equator to the South of the Sun's equator, the torque would be applied differently I have absolutely no doubt that I am correct and that Jupiter's electromagnetic field has the same polarity as Earth's relative to axial spin; moreover, the magnetic axis of Jupiter and the magnetic axis of the Earth are opposite to the magnetic axis of the Sun!

46. Considering the scientific findings that I have presented which indicate that the planets affect an electromagnetic induction force into the Sun, it should be obvious that *the reverse is also true, i.e.*, the triggering of the release of energy in sunspots also have an electromagnetic induction force into the planets. [I remind the reader of Newton's Third Law of Motion: "To every action there is always opposed an equal reaction: or, the mutual actions of two bodies upon each other are always equal, and directed to contrary parts."]

46
A. Consequently, the weather on all the planets is certainly influenced by sunspot activity.

46
B. Reference Section 49-I concerning the "Devil's Sea," "Bermuda Triangle," and other such geographi-

"... the triggering of the release of energy in sunspots also have an electromagnetic induction force into the planets."

cal areas: I postulate that such areas are subjected to electromagnetic lines of force which leave the Earth's surface at those areas and travel to the region where the Earth's general electromagnetic field merges with the Sun's electromagnetic field.

46
C. My hypothesis brings to mind the finding that "loops" of magnetic lines of force have been detected leaving the Sun's surface and traveling into Space. *You will note that the drawing depicted in Section 49-I matches the description provided here concerning the Sun. Such lines of force are traveling to the same point in our Galaxy's magnetic field.*

46
D. Therefore, the weather is probably affected (to some degree) if, because of the electromagnetic induction effect, the planets are struck by these "loops" as the Sun rotates.

46
E. To those scientists who have had the insight to recognize a relation between sunspot activity and the Earth's weather — and who have endeavored to convince "closed minds" of this fact — all of my combined findings are scientific proof that your convictions are correct.

47. Dr. Robert Smith recommended that my hypothesis should be capable of explaining the years 1645-1715 (Maunder Minimum) when there was little or no sunspot activity. [For further information on this subject, see the article entitled "When The Sun Went Strangely Quiet," pages 154-156 in the March 6, 1976 issue of *Science News*.]

47
A. Previous findings have demonstrated that the triggering of sunspot activity is principally influenced by the planets.

47
B. The evidence indicates that the planets act as a triggering mechanism that accelerates the conversion of the Sun's Matter into electromagnetic energy.

47
C. Therefore, when the planets do not trigger sunspot activity, this would indicate that the Sun's total Matter conversion processes had weakened.

47
D. The question one should ask is: "Why is the Sun's total Matter conversion into electromagnetic energy a *variable* and not a *constant* process?"

47
E. There is a possibility that the planet's electromagnetic fields decreased in strength and consequently reduced their electromagnetic induction strength into the Sun. However, I suspect other causes.

47
F. There is also the possibility that the satellites of Jupiter and Saturn (all of which have electromagnetic polarity opposite to all the planets) become aligned, thereby reducing the electromagnetic effects of the planets. However, I suspect other causes, since these satellites remain aligned for only a short time.

48. Consider the negative and positive effects that the planets have in triggering the induction of sunspot activity. **It then seems logical that star alignment would have an even greater negative and positive effect upon the total processes of the Sun!**

48
A. It is estimated that it takes 200 million years for the Sun to make one orbit of our Galaxy. There are also an estimated 100 billion other stars orbiting our Galaxy — some requiring longer and others a shorter period of time to make one orbit of our Galaxy. As a result, many conjunctions of other stars and the central force of our Galaxy will occur.

48
B. Re-examine Figure 38-A. It should become obvious that the Sun — in its orbit around the central force of our Galaxy — will come into conjunction with many other stars as well as the central force. It is also

"... varying star alignments will induce some type of sunspot activity in the central force of our Galaxy."

obvious that these conjunctions will vary greatly in terms of the number of stars in conjunction *at any one time*. Considering the previous findings which I have presented in this Book, it should be apparent that these varying star alignments will induce some type of sunspot activity in the central force of our Galaxy. The electromagnetic output of this central force will vary according to such varying star alignments, and such varying output will affect the Sun's rate of total conversion of Matter into electromagnetic energy.

C. Our Sun and other stars will be above or below the equator of the central force of our Galaxy, and the polarity of sunspot-type activity within this central force will reverse as it does within our Sun. There will be times when our Sun is in electromagnetic harmony with this sunspot-type activity of the central force of our Galaxy, and there will be other times when our Sun is not in electromagnetic harmony. (Refer to

“This harmonic variance will affect the total conversion of the Sun’s Matter into electromagnetic energy.”

Figures 38-A and 44-M.) This harmonic variance will affect the total conversion of the Sun’s Matter into electromagnetic energy. [Such an effect is similar to how sunspot activity affects the Earth’s meteorology, earthquakes, and the “Devil’s Sea”/“Bermuda Triangle” areas; I will discuss these two geographical areas in Section 49. By combining the information in Sections 46-C and 49-I, I will demonstrate a correlation of electromagnetic loops for these areas and electromagnetic loops of the Sun.]

48

D. The above findings provide a scientific explanation for large solar flares which occur when sunspot activity is at a minimum. Because sunspot-type activity of the central force of our Galaxy affects the electromagnetic loops of the Sun (as I have already explained for the Earth), such activity will also affect the conversion in certain areas of the Sun’s Matter into electromagnetic energy.

48

E. **Because of stellar alignment within our Galaxy**, there have been periods of time when the total conversion processes of the Sun were weakened to the point that the planets did not trigger sunspot activity, *i.e.*, the Maunder minimum. Considering this point, it should be logical that *the reverse will also be true*. [In addition, one must *also consider* inter-galactic alignment with respect to the Central Entity which galaxies orbit. See Section 52-M.)

48

F. **Because of stellar alignment within our Galaxy**, there will be periods of time when the total conversion processes of the Sun will be strengthened to the point that the planets will trigger sunspot activity of greater intensity than any for which we have records. Remember, the distances the stars travel in their particular orbits are immense. It may require thousands or even millions of years to achieve a particular stellar alignment which would directly affect our Sun. I am convinced that just as the planets affect the Sun (and vice versa), so do the stars in our Galaxy affect the central force of our Galaxy (and vice versa) and so the Galaxies affect the Central Entity which *they* orbit (and vice versa).

G. The scientific facts of history verify that in the past the Earth has experienced extreme catastrophes. It is a reasonable prediction that such catastrophes will be experienced in the future unless we can prevent such catastrophes via a “Mastering” of the essential nature of astronomical activity. Simply because the human species exists upon the planet does not “automatically immunize us” from further catastrophe.

48

H. *However, I have absolutely no doubt that there is a logical solution to whatever problems we may encounter in the future!* Do not listen to “doomsayers” who “spout” only negative statements. Such individuals cannot speak for the *creativity of others who are willing to face any problem “head on” and solve it!*

48

I. Earlier in this Book, I have shown the reader a new source of unlimited power. Those thinking individuals who have “Mastered” what I have taught can accomplish any task. Conducting grids can be constructed in Space which will encompass the entire Earth. As a result, *electromagnetic fields of any intensity can be released to neutralize or harmonize with incoming electromagnetic induction from Space. With such construction the Earth’s weather can be controlled, created, and directed!*

48

J. If the scientific community assumes a firm stand and presents exacting scientific evidence that convinces the general public to take the necessary action capable of saving life and property, then this will be one of the most beneficial and predicted events in the history of science for inducing the general public to rally 100% behind the efforts of scientists. [Certain geographical areas of the Earth may be advantageous for conducting scientific experiments.]

“Electromagnetic fields of any intensity can be released to neutralize or harmonize with incoming electromagnetic induction from Space. With such construction the Earth’s weather can be controlled, created, and directed!”

48

K. For additional, factual, and independent verification of the sunspot/earthquake connection and explanation which I have presented in this Book, refer to the article entitled “Seismicity in sync with the sun?” in the April 27, 1985 issue of *Science News*. While the article discusses a correlation between sunspot activity and Parkfield, CA earthquakes, neither the article’s author nor the scientific community present an explanation for such correlation as I have done in this Book even before this fact.

49. The Bermuda Triangle

The following information was presented by the New Jersey Society for the Investigation of the Unexplained, founded by scientist Ivan Sanderson and consisting of mathematicians, geographers, geodists, electromagnetic engineers, and others:

⁴⁹
A. During World War II, both Japanese and U.S. Military planes plotted the Devil's Sea. Its size and pitch are similar to the Bermuda Triangle!

⁴⁹
B. It was also found that there appear to be unexplained happenings which occur within ten, equally spaced areas on Earth. Such areas are spaced at exactly 72-degree intervals — five areas in the Northern Hemisphere and five areas in the Southern Hemisphere.

⁴⁹
C. I found the above information quite thought-provoking! Such areas are not located more than 40° North or South of the Earth's equator and they appear to have an alignment of the Northern Hemisphere areas with the Southern Hemisphere areas. I could see that such geographical positioning coincided with the known scientific facts concerned with the positioning of sunspots upon the Sun. (Such sunspot positioning was discussed in Section 36-B.)

⁴⁹
D. I also found it very interesting that there are two places on the Earth where the compass needle points to true North and not to magnetic North. One of these places is in the area of the Bermuda Triangle and the other is in the area of the Devil's Sea. In addition, compass needles have been known to continually spin in these areas.

⁴⁹
E. I also find it interesting that a large percentage of unexplained happenings occur in June/July and December/January.

⁴⁹
F. These two periods represent the time of the year when the Earth is farthest or closest to the Sun and when the Earth makes a sharper curve through the Sun's electromagnetic field.

⁴⁹
G. This Book has already presented exacting scientific evidence for the relationship between the Earth's true and magnetic axes.

⁴⁹
H. Combining all of my previous scientific findings with the above information, I made the following hypothesis:

⁴⁹
I. I have hypothesized that at certain times the Bermuda Triangle, Devil's Sea, and probably several other areas on Earth (in each Hemisphere) have electromagnetic lines of force (consisting of gyroscopic particles/kinetic energy) which leave the Earth's surface *at these geographical areas* and extend into

Space at a region where the Earth's general electromagnetic field merges with the Sun's electromagnetic field. Specific regions upon the Earth's surface such as the Bermuda Triangle, etc., behave differently from the remainder of the Earth's surface in which the electromagnetic lines of force extend towards the North and South electromagnetic poles. (See Figure 49-I and Section 46-C.)

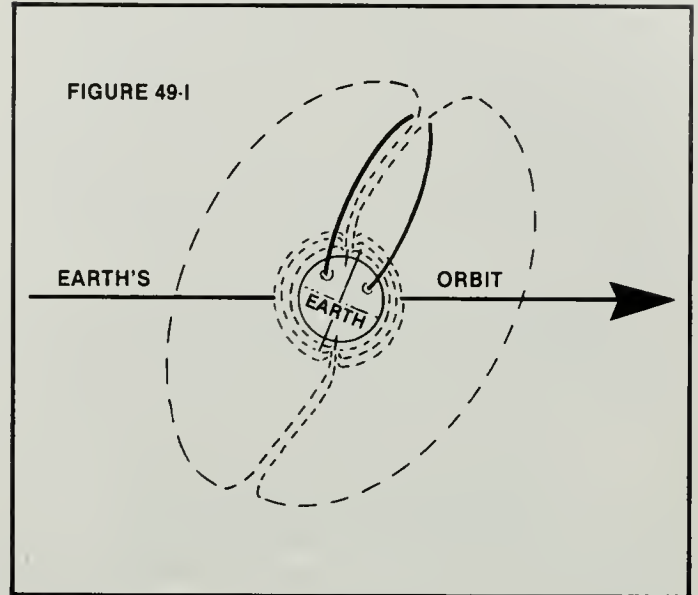

⁴⁹
J. Such a hypothesis would account for electromagnetic conditions which occur in certain areas while the balance of the Earth's surface is not noticeably affected. Realizing the similarities of these unusual areas upon Earth to the sunspot areas on the Sun, I concluded that there should be a connection between sunspot activity and electromagnetic induction into those particular areas on Earth.

⁴⁹
K. The greatest noticeable effect in these areas should be when sunspot activity is either decreasing or increasing. This would be true because as an electric current increases or decreases in a wire coil, the current creates an expanding and collapsing magnetic field and thus induces another current into a separate conducting coil of wire.

⁴⁹
L. If the reports regarding the Bermuda Triangle and the Devil's Sea are true, then it is apparent to me that these areas can possibly be the greatest "natural" scientific laboratories on Earth for learning more about the nature of electromagnetic energy. Matter may well be formed or converted into Energy in these areas.

⁴⁹
M. Any scientific experimentation in these areas should be conducted wisely. It is obvious that electromagnetic occurrences do not happen all the time and that they vary in intensity. It is also very likely that a human being would be in grave danger if Matter is strongly affected during periods of peak electromagnetic activity.

N. With a history of confusion and abnormal claims surrounding the Bermuda Triangle, one is tempted to dismiss the subject and reject the need for further investigation. However, one should not adopt such a close-minded attitude. I recommend reading the *Handbook of Unusual Natural Phenomena* by William R. Corliss. In this book, one will find over 500 pages of recorded, unusual phenomena and anomalies. If your mind is open to new considerations, you will observe that the common denominator of these documented facts of nature is an "electromagnetic effect."

Throughout the history of science, it has often been the *anomalies in nature* which have provided "fertile soil" for new discoveries and such anomalies have often been a source of curiosity stimulation to enhance our understanding of the Universe.

"This basic gyroscopic-action-entity prevails throughout our entire Universe and, in a mechanical sense, it electromagnetically couples the Universe into a single entity or universal energy machine!"

50. All natural motion (of planets, asteroids, stars, galaxies, etc.) in the Universe is the result of the movement of the basic gyroscopic-action-entity which comprises all Matter. *This basic gyroscopic-action-entity prevails throughout our entire Universe and, in a mechanical sense, this gyroscopic-action-entity electromagnetically couples the Universe into a single entity or "universal energy machine"!*

The basic gyroscopic-action-entity comprises all Matter: from the atom to the molecule to the everyday materials which surround us.

50

A. Examine the schematic diagram of our Galaxy taken from the book *Astronomy* by Fred Hoyle. However, study Figure 50-A in view of the material I have taught you.

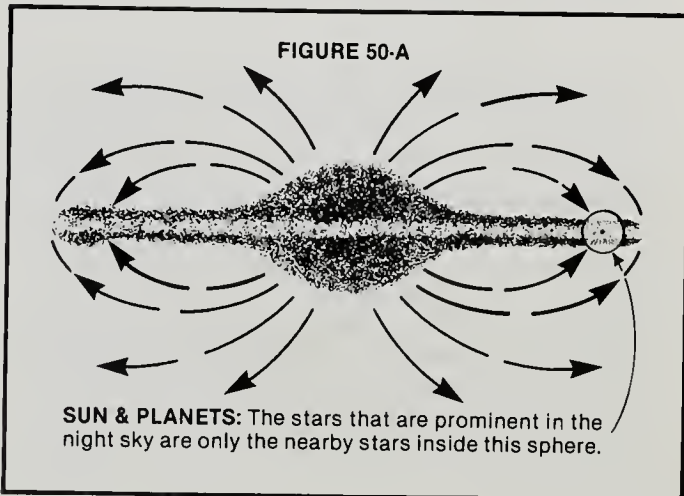

50-A

(1) Well over 100 years ago, Michael Faraday proved that neutrality to a magnetic field does not exist.

50-A

(2) I have taught and mechanically explained the "oneness" of the mechanical essence (*i.e.*, gyroscopic-action-entity) of Gravity, Electric Charge, Magnetism, Inertia, Matter, Light, Heat, Quantum Mechanics, and Universal Motion.

50

B. QUESTION: Do I have to teach you more? The answer is probably "yes" for those who have been unjustly taught to *memorize* statements presently taught in Astronomy.

51. EXAMPLE: Presently, it is debated as to whether or not the Universe is contracting or expanding. Based upon Red Shift observations, it is generally agreed that the galaxies are receding in a straight line.

51

A. However, I do not consider this exacting scientific evidence. *Example:* (See Figure 51-A.)

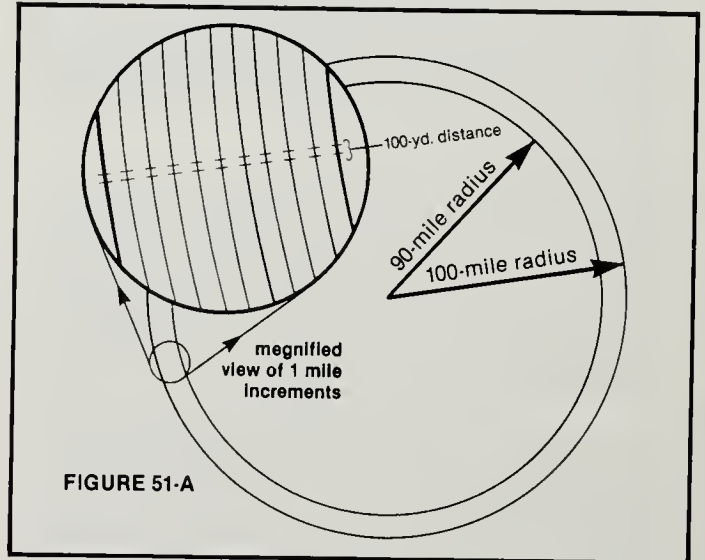

Draw ten concentric circles in which each circle's radius is one mile shorter than the next, *i.e.*, the largest circle with a 100-mile radius and the smallest circle with a 91-mile radius. On the perimeter of each concentric circle, measure a 100-yard distance from a point on which to start running a race. If one considers only those 100 yards on each circle with one man running in each lane, it would appear that the ten men would all be running in straight lines for the brief period of their 100-yard race. If they continued to run, they would appear to recede from the viewer in a straight line if the viewer only occasionally checked their positions.

51

B. The distances of the elliptical orbits of the galaxies are such that even a distance of 100 million miles could be considered at any one moment on those orbits and it would appear that the galaxies were all receding in a straight line.

C. I remind the reader that the true speeds of galaxies are not presently known. Their speed is relative to an observer on Earth who is in a most difficult position for recording exact astronomical measurements. A point on the Earth's equator rotates at 1,050 miles per hour, the Earth revolves around the Sun at 1,100 miles per minute, and the Sun moves throughout our Galaxy at 150 miles per second. In addition, our Galaxy is moving at a speed in its orbit that is different from other orbiting galaxies. How would you like to attempt to record exact measurements for the ten runners described in Section 51-A while you are spinning upon a complex mechanical apparatus which has the same motions that the Earth, Sun, and Galaxy have at fast speeds? (See Figure 51-C.) [The reader may find it of interest that in 1967 I taught the difficulty of recording observations under such conditions of complex motion via a Document which I sent to fifty-six major universities.]

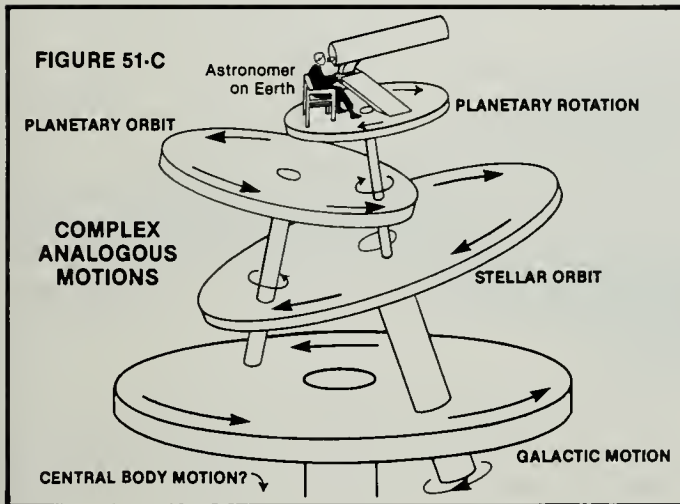

D. Considering these complex astronomical motions combined with my previous scientific findings, I stand with my Theory (teachings) stated in Section 33-D which I repeat:

E. It is my Theory (teachings) that a central electromagnetic field completely pervades our Galaxy's electromagnetic field and causes our Galaxy to align with and orbit it. Moreover, our Galaxy's electromagnetic field causes the Sun to align with and orbit within our Galaxy, since the Galaxy's field pervades the Sun's electromagnetic field. The Sun's electromagnetic field causes all the planets in our Solar System to align with and orbit the Sun since the Sun's electromagnetic field pervades all of its planets and their respective electromagnetic fields. The Earth's electromagnetic field pervades the Moon's electromagnetic field and causes the Moon to align with and orbit the Earth, just as the electromagnetic fields of the other planets pervade the electromagnetic fields of their respective moons.

Thus one has a "graded" series of mechanical motions which are physically integrated with one another via the nature and essence of the gyroscopic

particle — the basic entity of all Matter in the Universe and the entity which comprises all electromagnetic fields throughout the Universe. In essence, *everything in the Universe* moves in alignment with the gyroscopic-action-entity composition of respective magnetic and electric fields — an effect commonly called "gravity." As I have already stated, gravity is in reality the "Unequaling Effect" of the gyroscopic-action-entity composition of Matter.

51

F. At this point one may raise the following question: Does the Central Entity of the galaxies *also* orbit some *other* entity or does it "sit" suspended in space while spinning, motionless, or what? I am certain that such a Central Entity would at least be spinning, but this has yet to be proven. Could it, in fact, be orbiting an *even larger* entity?

52. Further observational proof that my teachings are correct is evident from an article entitled "The Case of the Cosmic Bends" in the August 6, 1984 issue of *Time Magazine*, page 57.

52

A. The article states that an astronomical test was conducted by the use of 27 radio telescopes placed across 21 miles of the New Mexico desert at a cost of \$78.3 million.

52

B. It is obvious to me that the scientists involved in the project were trying to be honest and dedicated individuals. However, judging by their conclusions, it is clearly demonstrated to me that such scientists have been "unjustly influenced" by our teaching system which actually rewards memorization and penalizes or ignores curiosity.

52

C. The *Time Magazine* article states that the scientists observed a "spectacular feature that has never before been closely observed: a band of gas 10 to 20 light-years thick, seemingly composed of lacy filaments, stretching up to 600 light-years above the plane of the Milky Way." (See Figure 52-C.)

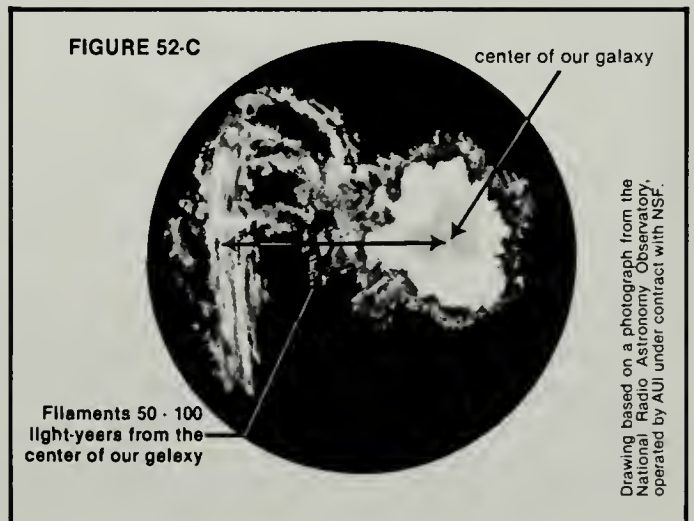

D. The article indicated that the observed “spectacular feature” was arced. The article adds:

“Indeed, the appearance of the magnetic arc was so unlike anything ever before observed in the universe that for weeks its three discoverers refused to accept their own finding.

“... others are now leaning toward the presence of a powerful and mysterious magnetic field as the most plausible cause.

“The magnetic field, if it exists, defies scientists’ notions about proper celestial behavior. Perhaps even more baffling to astronomers, the belt of gas rises up at a right angle to the plane of the Milky Way ...” (Emphasis added.)

“So far the strange arc has raised only questions, not answers. Once gravity was thought to be the sole force shaping the large scale of the galaxy. Now it has lost some more of its supremacy to whatever molded the giant ribbon of gas.”

“Perhaps even more baffling to astronomers, the belt of gas rises up at a right angle to the plane of the Milky Way ...”

52

E. At this point, I will simply draw a figure of what these astronomers have discovered and compare the results with my teachings.

planets’ plane with respect to the electromagnetic axis of our Sun. (See Figure 43-A.)

52

G. The reader should return to Fred Hoyle’s statement (in Section 38-A) which he made many years ago and which clearly demonstrates the observed results in Figures 52-C and 52-E.

“... all galaxies orbit a Central Entity and are not traveling, expanding, or contracting to some unknown position in a straight line.”

52

H. Return also to my statement in Section 38-D in which I described a “duplicate effect” of the Sun’s polar plumes (featured in Figure 38-A2) and the top and bottom arrows of the galactic magnetic field in Fred Hoyle’s Figure 38-A. The reader can easily see the *exact same results* of our Galaxy’s plumes (“filaments”) as they mirror the “electromagnetic coupling effect” of our Galaxy to the Central Entity orbited by our Galaxy and other detectable galaxies.

52

I. It is obvious that our Galaxy has the same relationship to the Central Entity (which the galaxies orbit) as I have demonstrated that the Earth has to the Sun, the Moon has to the Earth (see Section 34-A through Section 35-I), the planets have to the Sun, and the Sun to our Galaxy.

52

J. Such observations enable me to conclude that *all* galaxies orbit a Central Entity and are not traveling, ex-

FIGURE 52-E

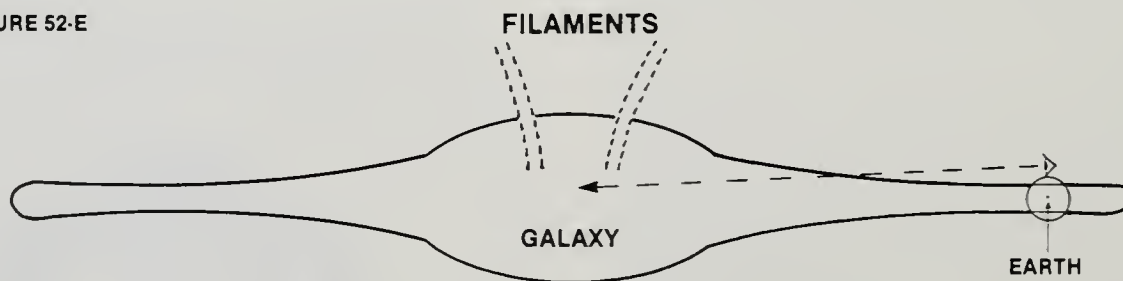

Figure 52-E is based upon the description provided by the astronomers who have detected these magnetic filaments arcing from the core of our Galaxy.

52

F. Observe in Figure 52-E that the galactic plane with respect to its electromagnetic axis is the same as the

panding, or contracting to some unknown position in a straight line. (Remember that it is estimated to require 200 million years for the Sun to make one complete orbit of our Galaxy. One may extrapolate that this time is probably squared [or better] for our Galaxy to make one complete orbit around its Central Entity.)

K. What is known about observed galactic motion should be updated to a drawing such as Figure 52-K:

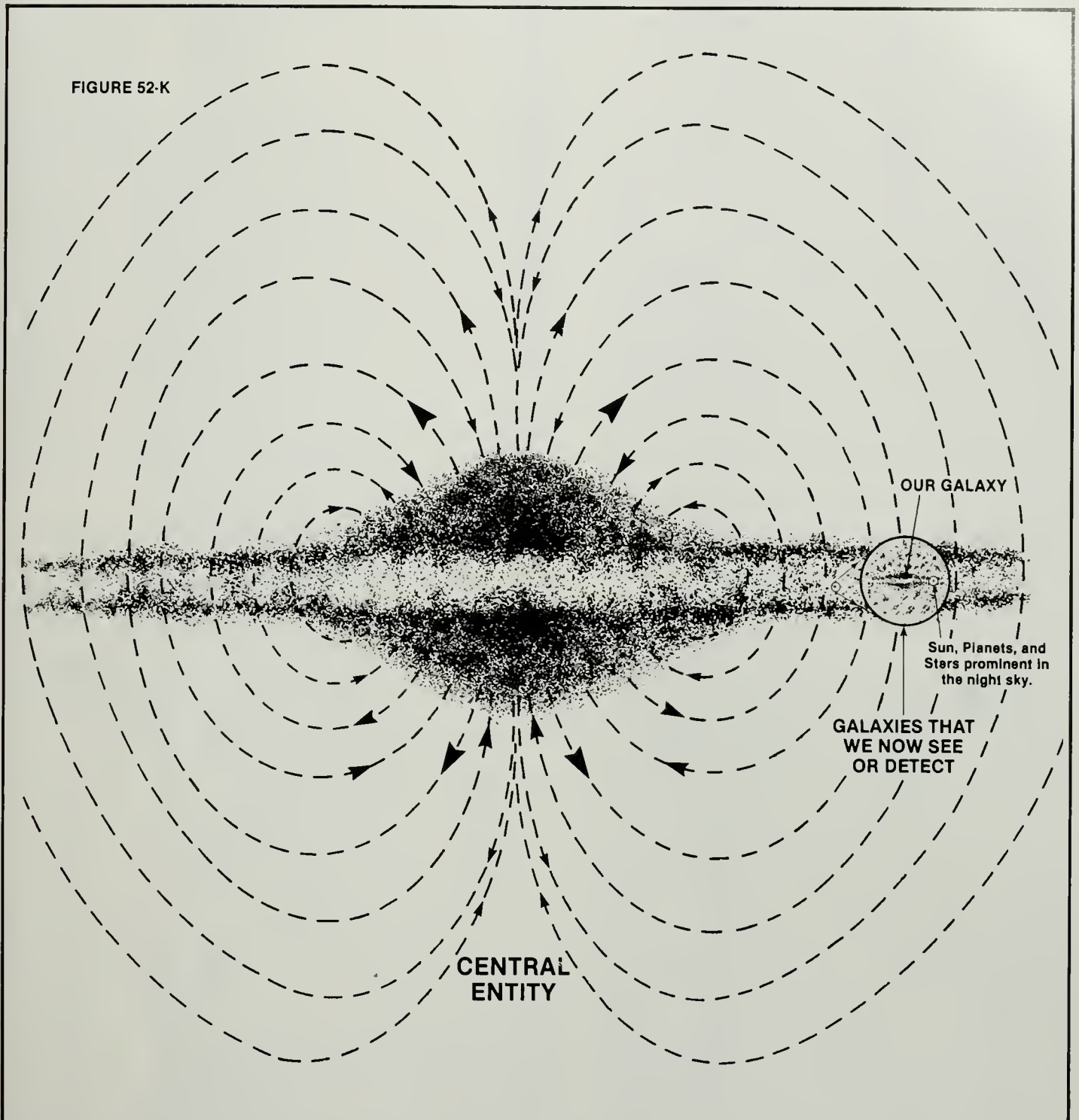

QUESTION: Does the Central Entity orbit some other, even larger, "Super-Central-Entity"?

52

L. As the facts of universal motion would indicate — planets to the Sun, stars to our Galaxy, and our Galaxy to its Central Entity — *all orbit in a plane* (see Section 42-A) *which is at right angles to the axis of the electromagnetic field of the entity being orbited.* (Field warpage will affect such angles.)

Such right angular motion clearly and consistently demonstrates the nature of the basic gyroscopic-action-entity composition of all Matter and Energy of the Universe, since, when *any force* (i.e., attraction, repulsion, centrifugal, etc.) acts upon this basic gyroscopic-action-entity, then that entity *moves at right angles* to that force resulting in a rotational motion of one entity around another. *The basic gyroscopic-action-entity mechanically unifies the various fields observed within the Universe.*

CHART 53-B

EARTHQUAKE AND VOLCANIC ERUPTION "DISASTERS" PLACED IN MONTHLY ORDER — DATES ARE HIGHLY SIGNIFICANT!

MARCH	APRIL	MAY	JUNE	JULY	AUGUST	September	October	November	December	January	February
YEAR DAY(S)	YEAR DAY(S)	YEAR DAY(S)	YEAR DAY(S)	YEAR DAY(S)	YEAR DAY(S)	YEAR DAY(S)	YEAR DAY(S)	YEAR DAY(S)	YEAR DAY(S)	YEAR DAY(S)	YEAR DAY(S)
1977 4	1906 ?	1976 6	1956 10	543 9	1949 5	1262 1	530 1	1755 1	856 ?	1962 10	1783 4
1963 17-21	1906 16	1902 8	1948 28	551 9	1868 13	1923 1	1737 11	1976 24	1631 16	1693 11	1797 4
	1906 18	1875 16	1976 26	1969 25	546 15	1975 6		521 29	1920 16	1915 13	1976 4
	1972 10	*1980 18		1963 26	1950 15	1954 9			1946 21	1907 14	1960 29
		526 20		1976 28	1896 16	1978 17			1972 23	1951 18	1953 12
		1293 20			1976 17	1290 27			1932 26	1536 24	
		1960 21-29			1966 19				1939 27	1939 24	
		1935 30			79 A.O. 24				1828 28	1531 26	
		1970 31			1883 26				1908 28		
					1886 31				1974 28		
					1968 31				1703 30		

*Mt. St. Helens initially gave warning of its potential on March 27, 1980, only six days after the Earth crossed the Sun's equator and went into opposite sunspot polarity. Cumulative effects then occurred within the volcano causing it to erupt on May 18, 1980. Over a four year period, Mt. St. Helens has produced activity within a 30-day period of March 21st — the day the Earth crosses the Sun's equator.

TORNADO AND HURRICANE "DISASTERS" PLACED IN MONTHLY ORDER — DATES ARE HIGHLY SIGNIFICANT!

MARCH	APRIL	MAY	JUNE	JULY	AUGUST	September	October	November	December	January	February
YEAR DAY(S)	YEAR DAY(S)	YEAR DAY(S)	YEAR DAY(S)	YEAR DAY(S)	YEAR DAY(S)	YEAR DAY(S)	YEAR DAY(S)	YEAR DAY(S)	YEAR DAY(S)	YEAR DAY(S)	YEAR DAY(S)
† 1925 18	† 1936 5-6	† 1896 27	h 1953 9	h 1967 9	h 1969 17-19	h 1930 3	h 1976 1	h 1971 1	-h 1974 25		† 1884 19
† 1932 21-22	† 1965 11	† 1953 11	h 1882 5	h 1955 18-19	h 1928 12-17	h 1928 12-17	h 1963 3-8	h 1970 13			
† 1952 21-22		h 1963 28-29	h 1957 27-28	h 1893 22-30	h 1947 15-19	h 1947 15-19	h 1881 8	h 1977 21			
		h 1965 11-12	h 1972 16-23	h 1900 27	h 1974 19-20	h 1974 19-20	h 1960 10/31	h 1703 26-27			
		Both Hurricanes in Pakistan!		h 1954 31	h 1934 21	h 1934 21	h 1954 12-16				
					h 1938 21	h 1942 16					
					h 1956 22-28	h 1935 21					
					h 1954 26	h 1959 27-28					
					h 1959 26-27	h 1876 31					
					h 1958 27-28	h 1949 31-2					

† = TORNADO h = HURRICANE

FIGURE 53-D

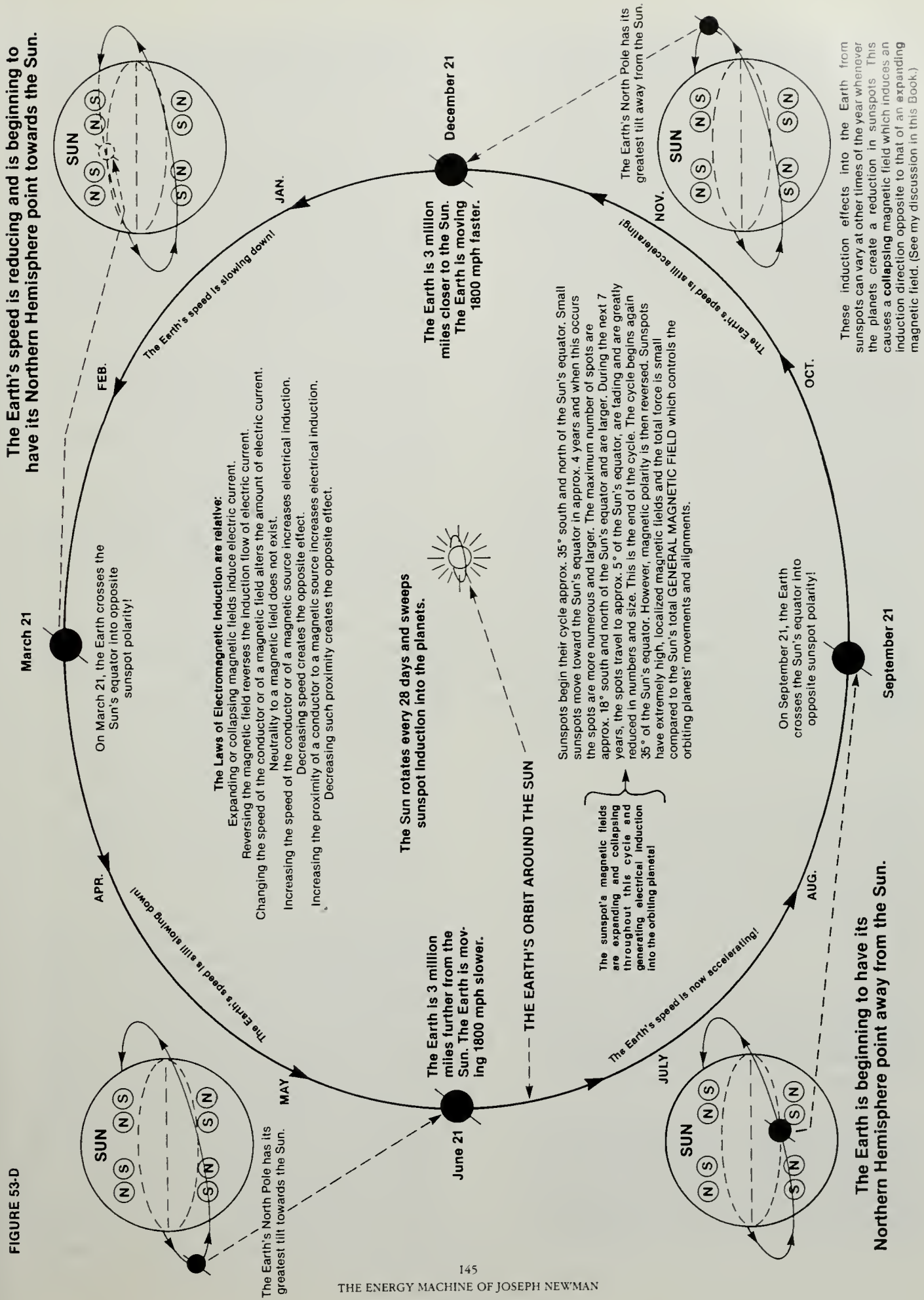

53. Additional proof that my teachings are correct is afforded by the scientific facts regarding "natural disasters." Because of Dr. Huntington's work, as well as my own, I searched for such additional proof. I initially attempted to locate the statistics concerning the exact dates for earthquakes, volcanic eruptions, and storms, but the exact dates were unavailable. Knowing that historians generally record the exact dates for such events which cost lives or cause great financial damage, I went to the library to search further. In the World Book Encyclopedia (published by World Books Inc., Chicago, Illinois, 1980 Edition) under the section "Disasters of the World," I did find the precise dates I had expected.

53

A. The reader should be aware that there was no orderly listing of the "natural disasters" for which I was searching. Therefore, I simply listed such events under Months-of-the-Year. The "Earthquake and Volcanic Eruption Disasters" and the "Tornado and Hurricane Disasters" were arranged in separate 12-month periods. *Reason:* The Earth's mass (inertia effect) of solid material is far more resistant to change than the mass (inertia effect) of gas molecules in the Earth's atmosphere. I therefore expected an "accumulation effect" for the Earth's solid material and a more "instantaneous effect" for the atmosphere (gases) of the Earth. I was also certain that these natural events would occur in accordance with the Laws of Electromagnetic Induction. I also knew 1) the speed of the Earth, 2) the Earth's tilt with respect to the Sun, 3) when the Earth crossed the Sun's equator into opposite sunspot polarity, 4) the direction of the Earth relative to sunspots varied from month to month, and I was certain that these facts would prove the existence of the electromagnetic effect.

53

B. See the "Disasters of the World" Chart 53-B arranged by months and observe that *many of these disasters occur very close to the same day under a given month even though such events occur hundreds of years apart from one another.* Observe that there is an "order" and "mechanical nature" (the electromagnetic effect) to these events:

53

C. Because Chart 53-B contains a random selection of scientific events on Earth (Disasters), the mathematics of probability states that these results will not noticeably change if the exact dates for *all* earthquakes, eruptions, and storms were included, *i.e.*, where loss of life and property damage were not significant.

53

D. Closely examine Chart 53-B and I will demonstrate how the description in Section 53-A applies to the observed results. The effects of the Laws of Electromagnetic Induction are quite obvious. Examine Figure 53-D concerning the Earth's motion and speed around the Sun as the Earth passes through initial sunspot induction and reverse sunspot induction.

53

E. The reader may find it interesting that Figure 53-D was published approximately on a full page of the *Mobile Press Register* newspaper on June 29, 1980, Section B. I had been informed that there would be a planetary "alignment" in 1982 and I predicted unusual storms, volcanic eruptions, earthquakes, etc., from 1980 through 1985 when the planets would then be in greater unalignment. Independently of my work, the national news media has since featured documentaries which have discussed unusual weather conditions around the world during this time. Such conditions cannot be explained by conventional wisdom. QUESTION: Do you the reader believe that I only "guessed" this result?

53

F. As it turned out, the action-reaction effect of storms, etc., was not as great as I had expected, so I searched further into the facts and found that *there was no planetary "alignment," but only a general-area-positioning of the planets* similar to a shotgun blast upon a target.

53

G. In my scientific document of 1976, I initially predicted catastrophes *whenever planetary "alignment" occurred.* Other individuals informed me that such "alignment" has already been predicted in a book entitled *The Jupiter Effect.*

53

H. The facts have clearly shown that there was NO "alignment," but only a very general, shotgun-blast-type alignment in 1982. *What the world has encountered from just that very slight "alignment" via earthquakes, storms, eruptions, etc., is only a preview of what will occur. It is possible that far greater "alignment" will occur in May of the year 2000. (As of the time of writing this Book, I have received conflicting reports regarding such alignment.) I urge the reader to Master what I teach. We have several years to prepare for effects that will occur several years before and after that date, if true alignment does occur.*

54. A. Return to Chart 53-B. Observe that a large number of earthquakes and volcanic eruptions (as Mt. St. Helens) began on March 21 when the Earth crossed the Sun's equator and entered opposite sunspot polarity. This caused an opposite electromagnetic induction effect into the Earth (*i.e.*, the Sun rotates every 28 days and sweeps sunspot induction into the Earth) as the Earth travels into a cumulative "action-reaction effect" since the greatest number of sunspots occur 18 to 20 degrees from the Sun's equator. The Earth is more likely to be affected by the sunspots in April and May due to the position of the Earth relative to the Sun. As a result, this cumulative "action-reaction effect" peaks upon the Earth in April and May.

54

B. The reader should note that for four sequential years, Mt. St. Helens — which is in the Earth's North-

ern Hemisphere — demonstrated volcanic activity around the time the Earth crossed the Sun's equator on March 21. By this time, the Earth has begun to point its Northern Hemisphere towards the Sun.

⁵⁴
C. On Chart 53-B for the month of June, the reader can observe that there is little sunspot activity affecting the Earth because the Earth is at its farthest distance from the Sun and has reduced its speed around the Sun by 1800 miles per hour. [Moving a copper wire *quickly* through and closer to a magnetic field's source, will have a different induction effect from that of moving the copper wire *slowly* through a magnetic field and further from the source of that magnetic field.] The slower speed of the Earth and its further distance from the Sun reduces the electromagnetic induction effect and thus produces a reduction in earthquakes and volcanic eruptions.

⁵⁴
D. During July, the Earth *begins to travel in an opposite direction relative to the Sun.* (Re-examine Sections 44-G and 44-H which demonstrate the electromagnetic effect of this direction change.) Sunspot reduction causes a collapsing electromagnetic field which in turn produces a greater electromagnetic effect. Such an effect is observed in July into August as the Earth is more apt to be influenced by sunspots which are most

and earthquakes peaking in December and January. Such peaking continues into February since the Earth's direction relative to the Sun begins to reverse on December 21.

⁵⁴
F. From December 21 through June 21, the Earth travels farther from the Sun and decreases its speed around the Sun. Similarly, in accordance with their particular orbital year which differs from the Earth's orbital year, the other planets will also alter their relationship with respect to the Sun which in turn causes increased/decreased sunspot activity. Such sunspot activity causes the Sun's electromagnetic fields to expand and collapse. This is further complicated by the Sun's rotation every 28 days which causes a "sweeping" electromagnetic induction effect into the Earth that is similar to the sweeping beam of a lighthouse.

The Facts I have presented clearly demonstrate the cumulative "action-reaction effect" caused by astronomical electromagnetic induction which results in earthquakes and volcanic eruptions upon the Earth.

55. A. Examine Chart 53-B concerning storms, hurricanes, and tornadoes. The same explanation which I have provided for earthquakes and volcanic eruptions also applies to tornadoes and hurricanes. There is a difference, however: the electromagnetic induction

"The Facts I have presented clearly demonstrate the cumulative 'action-reaction effect' caused by astronomical electromagnetic induction which results in earthquakes and volcanic eruptions upon the Earth."

numerous 18 to 20 degrees from the Sun's equator. There is also an increase in earthquakes and volcanic eruptions upon the Earth.

⁵⁴
E. On September 21, the Earth again crosses the Sun's equator and is again under the influence of fewer numbers of sunspots. However, the Earth is now in opposite polarity with respect to the Sun and the Earth's speed is still increasing which increases the electromagnetic effect. Maximum sunspot activity occurs 18 to 20 degrees North and South of the Sun's equator and the Earth is most apt to be affected by such sunspots in October and November. However, curiously enough, the "cumulative effect" lags behind that in the Spring. (See Section 54-A.) This lag is evident since the cumulative "action-reaction effect" peaks in December and January. The difference in timing may be a result of the Earth's speed, *i.e.*, on December 21 the Earth is closest to the Sun (three million miles closer than on June 21) and the Earth's speed increases by 1800 miles per hour compared to its speed on June 21. This greater proximity and speed increase magnify the electromagnetic induction effect of the Earth into the Sun ("triggering effect") and vice versa from the Sun into the Earth which results in the increased "cumulative effect" of volcanic eruptions

effect with respect to storms is not as cumulative as that for earthquakes and volcanic activity.

⁵⁵
B. The mass (inertia) of air molecules (gas) is extremely light compared to the mass of the Earth. Consequently, electromagnetic induction is more rapid in its effect upon the Earth's atmosphere (gases).

Examine the following facts:

^{55-B}
(1) **Spring is noted for tornadoes.**

^{55-B}
(2) **Fall is noted for hurricanes.**

^{55-B}
(3) **On March 21 the Earth crosses the Sun's equator and into opposite sunspot polarity. At this time the Earth's Northern Hemisphere begins to point towards the Sun.**

^{55-B}
(4) **On September 21 the Earth crosses the Sun's equator, but the Earth is now traveling in an opposite direction relative to the Sun (and to that direction of March 21), and the Earth again enters opposite sunspot polarity. At this time the Earth's Northern Hemisphere begins to point away from the Sun.**

⁵⁵
C. Compare the facts in Section 55-B with the Storm Chart in Section 53-B:

^{55-C}
(1) Six out of nine tornadoes occurred within 30 days of March 21 — the date the Earth crosses the Sun's equator into opposite sunspot polarity.

^{55-C}
(2) Two of the nine tornadoes occurred on March 21.

^{55-C}
(3) Approximately $\frac{1}{4}$ of the tornadoes occurred on March 21.

⁵⁵
D. CONCLUSIONS:

^{55-D}
(1) Realizing that there are 9 tornadoes occurring within 365 days, then the mathematical odds are 40.5 to 1 *against* a tornado occurring on March 21.

^{55-D}
(2) Realizing that 2 of the 9 tornadoes occurred on March 21, then the mathematical odds are 1,640 to 1 *against* two tornadoes occurring on the same date that the Earth crosses the Sun's equator.

^{55-D}
(3) The fact that I did not specifically select these tornadoes from a large number of tornadoes (*i.e.*, these were the only tornadoes listed under the "Disaster" section) provides sound scientific evidence that my teachings are correct.

⁵⁵
E. Compare the Storm Chart 53-B concerning hurricanes to statement 55-B:

^{55-E}
(1) Twenty-five of 36 hurricanes (69%) occurred within 41 days of September 21 — the day the Earth crosses the Sun's equator into opposite sunspot polarity.

^{55-E}
(2) Nine out of 36 hurricanes (25%) occurred within 6 days of September 21.

^{55-E}
(3) Four of the 36 hurricanes (11%) were formed within 1 day of September 21.

^{55-E}
(4) Two of the 36 hurricanes were formed on September 21. The mathematical odds *against* such an occurrence is 102 to 1.

^{55-E}
(5) Storm Chart 53-B demonstrates that tornadoes are concentrated in the Spring when the Earth begins to point its Northern Hemisphere towards the Sun and causes an electromagnetic induction effect upon the land surfaces of the Earth.

^{55-E}
(6) By comparison, the hurricanes are concentrated in the Fall when the Earth begins to point its Northern Hemisphere away from the Sun and causes an electromagnetic induction effect to be generally centered over equatorial regions which contain large bodies of water. The evapo-

ration effect and the electromagnetic induction effect combine to produce hurricanes.

⁵⁵
F. In the Fall (September 21), the Earth approaches the Sun and increases its orbital speed around the Sun. This causes the electromagnetic induction to increase and can result in greater air masses, *i.e.*, hurricanes.

⁵⁵
G. The variability of the following factors explains why hurricanes and tornadoes do not occur only at certain times, but vary from year to year, decade to decade, and century to century:

^{55-G}
(1) the "action-reaction effect" caused by electromagnetic induction as a result of increasing/decreasing sunspot activity triggered by planetary configuration

^{55-G}
(2) the "sweeping action" of changing electromagnetic induction effects generated by the Sun's 28 day rotation

^{55-G}
(3) the orbital speed of the Earth

^{55-G}
(4) proximity of the Earth and Sun

^{55-G}
(5) the Earth's Northern Hemispheric degree of tilt with respect to the Sun

⁵⁵
H. If tornadoes and hurricanes formed only as a result of interacting cold and warm air masses, then those storms could be very accurately predicted. But the facts prove the opposite:

^{55-H}
(1) Cold and warm fronts often meet and there are no hurricanes or tornadoes produced.

^{55-H}
(2) Hurricanes or tornadoes are often produced when they are not expected by meteorologists. This is why planes are flown into potential hurricane disturbances to physically detect and observe the storm's nature.

^{55-H}
(3) Totally unexpected, clear-weather tornadoes have been documented. [See *Handbook of Unusual Natural Phenomena*.]

^{55-H}
(4) Electrical and magnetic disturbances associated with tornadoes have been clearly documented. [For such documentation, I recommend reading pages 342 through 366 of the *Handbook of Unusual Natural Phenomena* by William Corliss.]

I. The following is a report of my personal experience from my scientific notes:

Unusual Electrical Observations

“Time: *Monday, 26 April, 1982, approximately 6:30 PM CST*

Place: *My home in the woods, approximately four miles from Lucedale, Mississippi*

From a northwest direction I observed a dark cloud moving towards my home and traveling in a southeast direction.

Because of my scientific work, I take such clouds seriously during this time of the year, and consequently, I opened all screened doors and windows, enabling differences in potential pressure changes to quickly equalize.

There was much lightning occurring within this cloud, but the lightning did not appear to be striking the Earth.

My home is in the midst of pines, dogwoods, oaks, etc. My closest neighbor is approximately three-quarters of a mile away.

My lovely, devoted wife Ellen and I began to hear a ‘zapping’ noise occurring in varying outdoor areas. At the time we had a German Shepherd named Sport (now deceased) and a part-Persian cat called Mama Kitty (whom we still have) which normally stay under the converted carport when a rain storm approaches. However, on this particular occasion, both the dog and cat left and went somewhere into the woods just as the cloud approached our house.

The ‘zapping’ noise sounded like an electrical discharge as one would normally hear from an electrified object discharging into another uncharged object.

There was lightning and thunder within the overhead cloud, but the lightning did not appear to strike the Earth.

As would any curious scientist, I observed the cloud and woods from varying positions of windows and doors.

Just as I was looking from one window in the direction from which the cloud was coming, there suddenly appeared directly in front of my vision — about 100 feet away — a very strong, swirling wind. I could see the trees vigorously twisting and twirling in that area. It was obvious that this was a rotational type of air current. What was so interesting was that the rotational air current started right in front of my eyes rather than coming through the pine thicket which begins about 200 feet in front of the open window from which I was looking.

The rotational air current came directly to our house and completely engulfed it. One of the doors I had braced open immediately and violently slammed shut. Before I could re-open the door, the rotational air current disappeared. (Within 20 minutes, the dog and cat returned.)”

55

J. These observations, those of others, and my years of work, totally convince me that a tornado principally results from differences in the electromagnetic induction potential between a cloud or air (gas) areas and a particular ground area.

55

K. The constant “zapping” noise we heard was coming from pointed limbs of trees, leaves, bushes, etc., discharging electrical charge from the Earth to the approaching cloud or vice versa. Such “zapping” ceased when the cloud was directly overhead.

55

L. This does not mean that other mechanical factors such as jet streams and intersecting warm/cold fronts do not play an important role, although such activity can also be electromagnetically motivated. *This action is called the “thermocoupling effect” when two different, hot and cold conducting materials are con-*

nected and produce electricity. Up to a point, the greater the difference in temperature, the greater the current produced.

55

M. It is my opinion that tornadoes and hurricanes form more easily over flat or cleared areas since a stronger electromagnetic difference will exist (without quickly dissipating) between the Earth and the gasses (atmosphere and clouds) above the Earth. This same electromagnetic mechanical effect is observed with respect to lightning. Lightning rods will reduce or eliminate the damaging effects of lightning.

The very fact that a tornado will often slowly extend from a cloud towards the ground but fail to touch the ground, or may touch the ground and then lift again (and repeat this procedure many times) — clearly demonstrates this electromagnetic effect. (See Figure 55-M on the next page.)

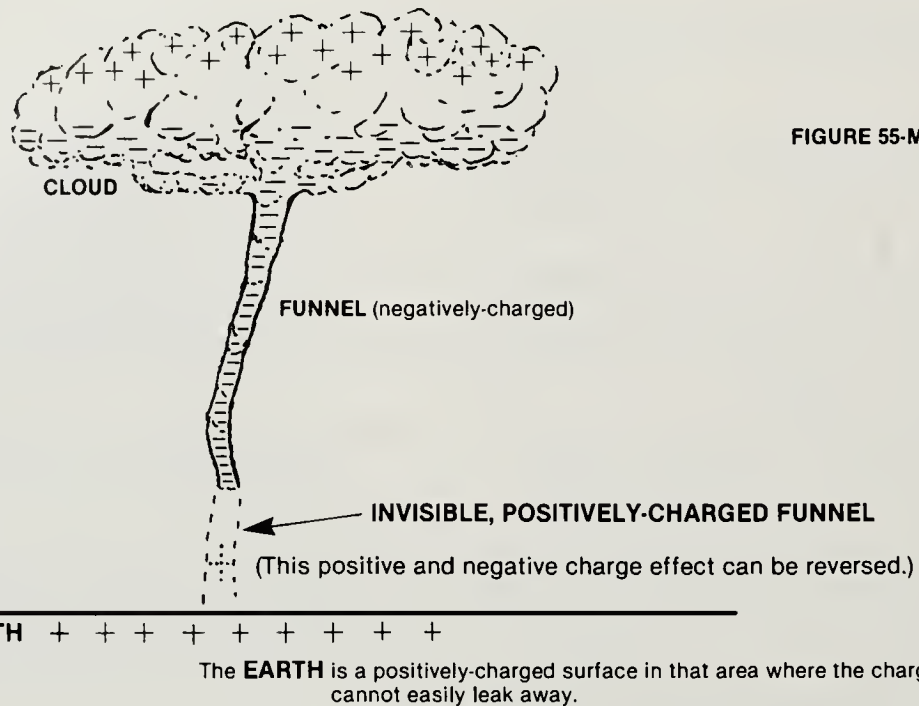

Therefore, a tornado has an invisible, positively-charged funnel which rises from the ground and meets the negatively-charged cloud funnel. [I have already demonstrated that charges are composed of an infinite number of gyrosopic particles. Consequently, the spinning funnel is to be expected.]

The funnel will lift again as the cloud becomes more neutrally charged. Lightning represents the same mechanical, electromagnetic effect. However, in a tornado, the funnel can maintain a more direct and shorter distance of charge flow from the cloud or gas (clear atmosphere) and the Earth. The funnel lifts and drops according to the "charge differential." For the same reason, a funnel will start from the ground and rise into the air (gas).

⁵⁵
N. A Kansas farmer, Will Keller, once saw what I have described. On June 22, 1928, while standing in the cyclone-celler door, Keller looked directly up and into the center of a tornado passing over his head. On page 132 of the *Time-Life* book entitled *Storm*, Will Keller states:

"... the walls of this opening were of rotating clouds and the whole was made brilliantly visible by constant flashes of lightning which zigzagged from side to side.

"Around the lower rim of the great vortex, small tornadoes were constantly forming and breaking away. These looked like tails as they writhed their way around the end of the funnel. It was these that made the hissing noise. I noticed that the direction and rotation of the great whirl was anti-clockwise, but the small twisters rotated both ways — some one way and some another."

This eye-witness description most definitely describes a charged funnel!

⁵⁵
O. Quoting from the *Handbook of Unusual Natural Phenomena* by William Corliss, page 342:

"... conventional wisdom also has trouble dealing with forked waterspouts [Figure 55-Oa], waterspouts stretching between clouds [Figure 55-Ob] and waterspouts with two concentric tubes [Figure 55-Oc]."

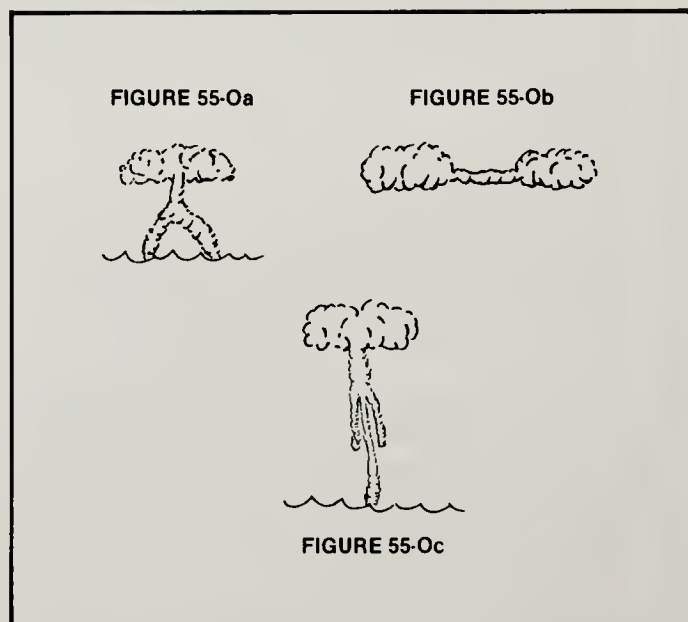

My comment: Those waterspout descriptions are clearly a description of electric charge (electromagnetism). This same effect is observed in connection with lightning.

Quoting again from the *Handbook of Unusual Natural Phenomena*, page 343:

Electric Currents Accompanying Tornado Activity, Brook, Marx; *Science*, 157:1434, 1967. Abstract. *Measurements of the magnetic field and earth current in the vicinity of a tornado show large, step-like deflections coincident with the touching down of the funnel. Calculations with a simple current model indicate that a minimum current of several hundred amperes must be postulated to account for the observed deflection in a magnetic field. The existence of a steady current of 225 amperes for a period of about 10 minutes provides joule heat at the rate of approximately 10^{10} joules per second, and involves a total charge transfer of 135,000 coulombs. The calculations imply that a tornado is electrically equivalent to several hundred isolated thunderstorms cells active simultaneously.*"

⁵⁵
P. There are many additional pages of facts in the *Handbook of Unusual Natural Phenomena* which verify the electromagnetic effect and nature of tornadoes or waterspouts. *The observation in Section 55-O verifies the unusual electromagnetic intensity of a tornado. Again, this matches my teachings of increased electromagnetic induction from sunspots and/or the Sun.*

⁵⁵
Q. The above facts still necessitate a thorough mechanical understanding of the "action-reaction, electromagnetic induction effect." Consider all that I have taught and then examine Figure 55-Q.

In 1982, there was only a shotgun-type planetary alignment with the Earth and other planets on the *same* side of the Sun. However, from 1980 through 1983, unusual weather conditions, eruptions, etc., verify the "effect" of even a very minor planetary alignment. Even the news media have had reports on the unusual weather conditions throughout the world during this period.

⁵⁵
R. Although I am not certain as of this writing that it is true (but I do consider it potentially important enough to include in this Book), I have been informed that there will be a far more direct planetary "alignment" (similar to Figure 55-Q) except that the Earth will be on the *opposite side of the Sun from the other planets*. I was informed of such alignment by Tom Valentine — author of a book entitled *Life and Death of Planet Earth* (which I have not read) — who had an astronomer at Northwestern University compute alignment degree and date. According to the astronomer, there would be *very close to a straight-line, planetary alignment during the month of May 2000*. (Some individuals have also indicated a similar planetary alignment for that period while other individuals have indicated that there would be not true planetary alignment for that period. However, it is *very important* that astronomers conclusively confirm or deny such alignment and be capable of predicting when true planetary [as well as stellar] alignment would occur.)

⁵⁵
S. *Of this I am certain: if such direct planetary alignment does occur, the Facts have proven that "great havoc" will be experienced by the Earth if me-*

FIGURE 55-Q

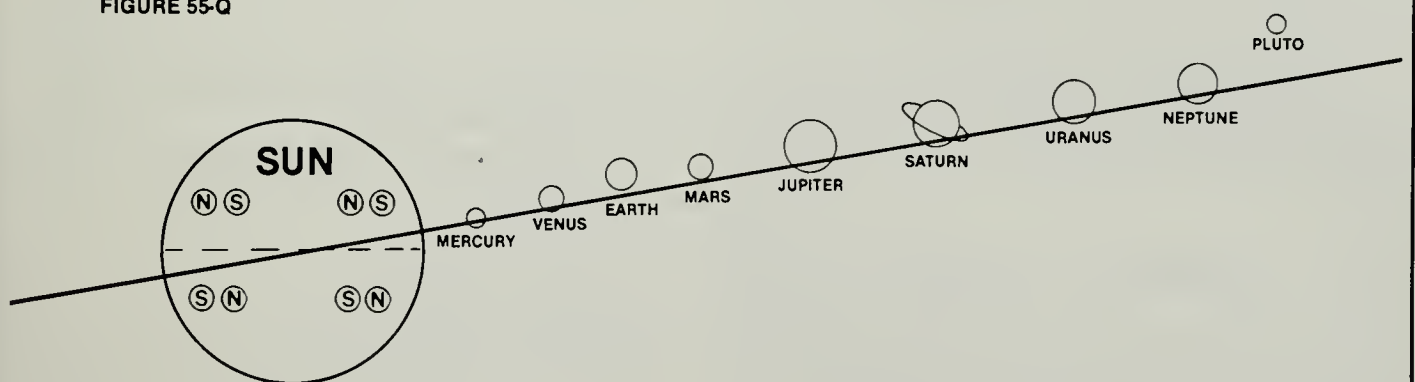

QUESTION: What do you expect will occur on Earth when all of the planets align in a *direct line on one side of the Sun*? What would occur upon the Earth if the planetary alignment was continuous except that the *Earth was on one side of the Sun by itself*?

chanical preparation is not undertaken! [I must add that the effect of such alignment upon the Earth will be influenced by the number of planets aligned, their actual degree of alignment, the planets' orbital position/speed with respect to the Sun at the time of such

alignment, and the effect of any degree of stellar alignment during this time.]

56. I now offer the following positive and creative concepts:

(1) I have taught the safe means for an enormous release of energy via $E = MC^2$.

(2) It is quite obvious that if excess electromagnetic induction causes any type of havoc upon the Earth (in May 2000 or at any time in the future), then the *opposite* must also be true: *one must produce an electromagnetic cancellation or control mechanism and such havoc will not occur!*

56
A. For example, consider a potentially dangerous storm which is capable of producing tornadoes. (See Figure 56-A.)

56
B. Instead of the meteorological formation in Figure 56-A, I propose the following:

56-B
(1) A single large conducting grid or numerous conducting grids (with conducting connection to Earth) composed of aluminum can be either raised in the air (see grid in Figure 56-B1) when a storm approaches or can be carried to the potential storm as it begins to form. Massive balloons (see Figure 56-B1a) could actually lift the aluminum grid.

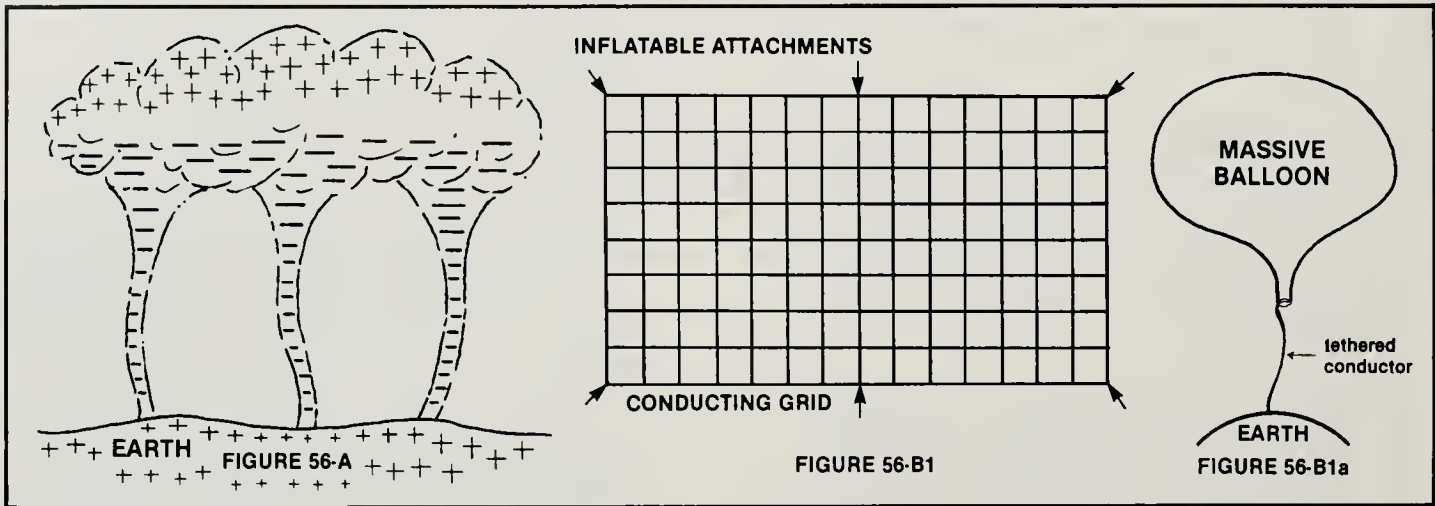

56-B
(2) In fact, the massive balloons should be coated with a good conducting substance. If properly performed, the massive balloons could be used in large numbers in lieu of the grid. The balloon mechanism could also offer tethered conduction to the ground.

56-B
(3) The most efficient design would be to utilize the energy source I have innovated and couple it with strong laser beams, X-rays, etc., to ionize the air throughout the cloud and to produce a good conducting connection between the Earth and the cloud as well as within the cloud itself. (See Figure 56-B2.)

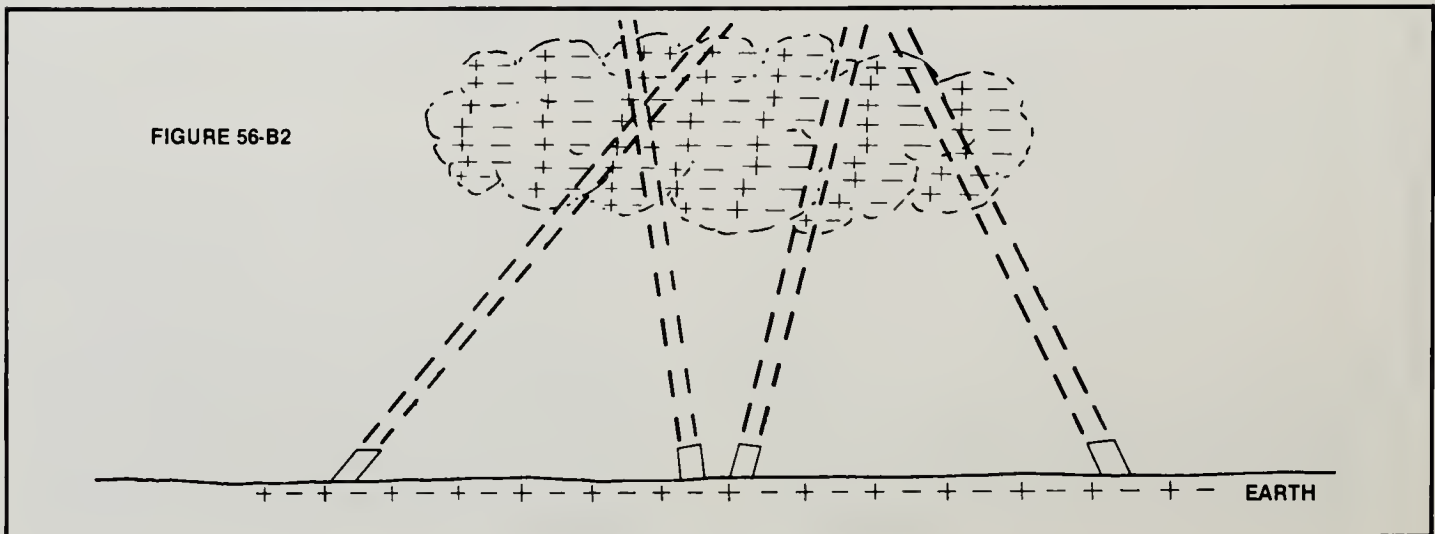

The lasers, etc., would be grounded, made to pivot, and placed at numerous points. If desirable, such lasers can be portable. I have learned that during the attempt to develop laser weaponry, the air ionization has been a problem by producing wasted energy. However, this problem is the *desired result of my proposal*. I have provided the energy source as the means.

⁵⁶
C. I strongly recommend that testing begin in earnest throughout major laboratories and universities — *NOW!* Clouds can be produced in a closed environment with a charging source for the produced clouds.

“... the solution will allow the world to produce and direct its weather at will.”

One can also produce an opposite charge on an artificial Earth within that closed environment. Under such conditions, one can test for the simplest, most efficient, and practical means to discharge the charged cloud to the artificial Earth as well as the mechanism necessary to intercept and cancel unwanted electromagnetic induction from the charging source.

⁵⁶
D. *I have no doubt that with such tests utilizing proper temperature differences, etc., one would find that the physical spinning of the entire environment within the test will generate the same results produced by natural storms observed on Earth: tornadoes and hurricanes.* When perfected, this would be a good test for Skylab.

⁵⁶
E. *A passive, “wait-and-see” attitude cannot be tolerated. Start to properly understand and prepare the mechanism NOW!* The ultimate goal is to stop all undesirable electromagnetic induction into the Earth’s environment. Superior technology will ultimately enable us to stop such undesirable electromagnetic induction in outer Space. This is why we must first perfect the technology on a small scale with Earth’s weather, and then apply such technology to outer Space. *When this occurs, we will be able to produce and direct our weather at will!*

⁵⁶
F. All of these “action-reaction, electromagnetic induction effects” can be duplicated in a laboratory (see Section 56-C) and *a mechanical means can be developed to intercept and redirect or cancel undesirable electromagnetic induction.*

57. Such undesirable effects constitute a problem faced by the entire world. *The entire world should and must unify as an entity of one!* The potential problem posed by planetary alignment can be converted into a positive tool for the benefit of all humanity. As I have already stated, *the solution will allow the world to produce and direct its weather at will.*

⁵⁷
A. I am very hopeful that this impending potential catastrophe (if it occurs in May 2000) can instead be converted into a positive benefit to encourage the entire world to think and work as a family of one.

⁵⁷
B. If the world can solve this potentially serious problem, then we will become aware that *as a family of one we can solve all problems.*

⁵⁷
C. If this potential catastrophe is not *now* acted upon, then it is possible that world devastation could be compounded by radiation leakage from nuclear reactors if any remain in functional existence. In addition, such possible devastation could possibly trigger nuclear weaponry, etc.

⁵⁷
D. I did *not* initially search for this potential disaster. On the contrary, the facts I have gathered proved to me that such disaster could be the case. Therefore, I searched for further proof. To do less would be irresponsible and totally unscientific behavior on my part.

⁵⁷
E. These statements concerning potential planetary problems have not been offered in a negative manner but just the opposite: they are made in a most positive manner. *It is my sole purpose to contribute to the “well being of all humanity.”*

“Consider the fact that up to this time, no one has offered a single mechanical explanation for phenomena that we observe in the Universe.”

58. What I teach is the means via a new source of energy (gyroscopic particles) to eliminate, control, and predict future disasters as well as to produce, control, and direct our weather. We will have the ability to convert deserts into oases by being able to convert salt water to fresh water and acquire valuable minerals in the process. Energy availability or environmental pollution will not be problems. Space travel will become commonplace. In fact, innumerable scientific doors will be opened.

⁵⁸
A. These many pages are the results of my sincere efforts to seek “TRUTH.”

⁵⁸
B. Observe that I have presented a single, scientific, mechanical explanation that has been consistent throughout my teachings, even though I have discussed many diverse scientific effects and subjects. Consider the fact that up to this time, *no one* has offered a *single mechanical explanation* for phenomena that we observe in the Universe.

Surely, he who “Masters” what I have written will understand the order of “TRUTH” in what I have taught.

I wish to pay “tribute” to Michael Faraday who was also correct and whose work inspired my search.

Chapter 20

ACHIEVEMENT VS. APATHY

"Men of great learning and retirement often contribute little or nothing to the progress of improvement. They spend their time in learning and admiring the inventions of others, without ever proposing a new thought of their own, or ever discovering one useful power in nature."

— Josaph Black

59. TO ALL WHO "MASTER" AND ARE INSPIRED BY WHAT I HAVE TAUGHT, IN THE REMAINDER OF THIS BOOK I SPEAK TO YOU:

⁵⁹

A. All of the many preceding pages of my teachings mean absolutely nothing if the major deficiencies of world society — fear, greed, intellectual dishonesty, and a lack of curiosity/intellectual aspiration — are not supplanted with superior attitudes.

I ask you — who I seek to inspire — to please "Master" my teachings which can correct such deficiencies. It is you who must apply what I teach to the world. With such application, I will predict the possibility of world peace as well as a productive and meaningful life for all individuals.

⁵⁹

B. It is only fair that I justify my sincerity and dedication to this desirable goal. Consequently, I will begin by providing you with a history of my efforts in the development of all that I have already taught.

⁵⁹

C. The following represents a very small sample of my voluminous correspondence with scientific agencies, universities, individuals, and elected officials. It is my hope that such correspondence will convince you of my dedication to what I teach.

Joe W. Newman
3062 Pickell Drive
Mobile, Alabama 36605

President Lyndon B. Johnson
The White House
Washington, D. C.

July 31, 1967

Mr. President:

I know you will receive this during troubled times and I would not impose upon you except that it be imperative that mankind utilize the attached information and that our nation be first to benefit by it.

I have not written, expecting that you prognosticate whether or not the attached information is of value; but to convince you of my sincerity; whereby, you will use your influence to insure that the attached scientific document is given all available scientific consideration with the greatest expediency.

I make my living inventing better machines. I do not allow myself the luxury of a mistake. With the funds derived from inventing, I do scientific research alone. I do this research not for money but because I am mentally compelled to do so. If I had all the money in the world, I would still do and get more pleasure out of research than anything man has to offer.

I am appalled at man's neglect for his fellow man. I have made myself a vow that I will not mentally be satisfied with myself until I have produced a machine and the method; whereby, the basic problems of mankind are a thing of the past. This attached document is a step in that direction. If I can get recognition for the information disclosed in this attached document, this recognition should enable me to get a grant from some source to build a prototype of the above mentioned machine, which I have already designed. I will also finish a document on the merger of economics and mechanization, as the method I mentioned above.

I respectfully await your earliest possible reply.

Sincerely,

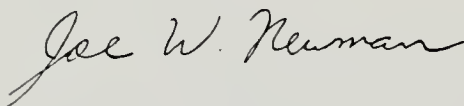
A handwritten signature in cursive script that reads "Joe W. Newman". The signature is written in dark ink and is positioned above the typed name.

Joe W. Newman

JWN:g

Attachment

March 9, 1974

1541 Bracher Drive
Houston, Texas 77055

President Richard M. Nixon
The White House
Washington, D. C.

Mr. President:

Please find attached a cover letter and scientific document I am sending out to the scientific community.

I have not written asking you to give an opinion, but that if what I have written is correct; you would have the insight to know the information on the last page is also correct. I am certain an unlimited source of energy is possibly obtainable within one years time.

With the understanding of the importance of this possibility, I request you have qualified opinions be given you.

Mr. President, I am correct!

Sincerely,

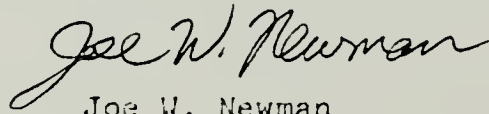
A handwritten signature in cursive script that reads "Joe W. Newman".

Joe W. Newman

JUN/e

Enclosure

December 30, 1974

1521 Deerwood Drive, East
Mobile, Alabama 36618
Phone: 205-344-9767

President Gerald Ford
THE WHITE HOUSE
Washington, D. C.

Dear Mr. President:

I doubt seriously that this letter will ever be brought to your attention, but the immense importance of this subject matter compels me to try.

Since 1967, I have diligently sought specific scientific argument against scientific material I have written. When I have personally approached Physics Professors they said I should get the opinion of Astronomy Professors and the Astronomy Professors would say I should get the opinion of the Physics Professors.

Through persistence, I have received correspondence from National Aeronautics and Space Administration, Atomic Energy Commission and National Science Foundation.

Of all the comments received from the scientific community, none have given specific scientific argument which has given me any doubt concerning my hypothesis. Any arguments first presented, disqualify themselves after I present my arguments.

All three of these National Departments end up suggesting that I get a scientific journal to publish my hypothesis. My Scientific Document and copies of all correspondence mentioned are attached, including scientific journals.

Most of the scientific community I forwarded a copy of my hypothesis made no comments.

The reluctance of the scientific community to take a stand on my hypothesis is illustrated by my correspondence with Dr. Dessler with the Space Science Department of Rice University in Houston, Texas. After reading my document, he called my by phone and give me his opinion. Quote: "I would not attempt to debate with you what you have written, you probably could be one of the greatest theoretical thinkers that has ever lived. However, I can imagine you are having difficulty getting response from other scientists because you have not presented your arguments in the accepted scientific form expected by the Scientific World. I would advise you go back to college to learn how to present your arguments in the accepted form." Unquote:

How ironic, that form and credentials are of more importance than the hint of truth to the scientific community.

President Gerald Ford
Page two
December 30, 1974

It should be apparent that I am not the average individual. Therefore, I must be a quack who can offer nothing of benefit to mankind or I must be a person with the ability to be of service to mankind. I have forwarded all of this material, whereby, you would be able to form an opinion as to which I am.

Mr. President, the World is in such an unstable economic condition that if there is the slightest indication that I am correct in my hypothesis, immediate action should be taken that would disprove or prove my hypothesis.

I welcome and challenge any scientist in the World to debate with me on my hypothesis by exacting scientific argument. Truth is what is important here, not form or credentials. Surely, all of my work and efforts have earned me the right to expect the scientific community to take a stand; to agree or disagree in no uncertain terms.

The conclusion of my nine years of lengthy experiments, study and creative thought is that I am saying an Unlimited Source of Energy can be released from Magnetic and Electric Fields of Force. I have at present drawings of a prototype device that would accomplish this result. I estimate an investment of \$200,000. and within one year of diligent experiment, positive results. Because of its great importance, I have not shown this drawing to my Patent attorney or any investor.

I await your earliest possible reply.

Mr. President, I am correct!

Respectfully,

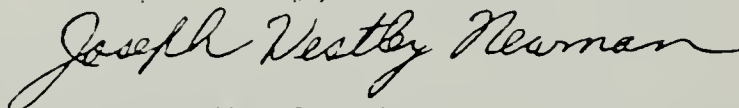

Joseph Westley Newman

JWN/en

Enclosures

August 28, 1975

1521 Deerwood Drive, East
Mobile, Alabama 36618
Phone: 205 - 344-9767

Vice-President Nelson Rockefeller
ATTN: Mr. Frank Pagnotta
THE WHITE HOUSE
Washington, D. C.

Dear Mr. Vice-President:

I talked with Mr. Lacey by phone on the night of August 26, 1975, while you and he were in Mobile, Alabama. Mr. Lacey advised me to send this letter and the enclosed material to Mr. Pagnotta and that he would personally see to it that you received this immensely important material.

Please find enclosed a copy of my scientific document, a copy of Dr. Edward Leverne Moragne's letter dated August 7, 1975, concerning my document and a separate page showing Dr. Moragne's scientific accomplishments, a copy of a letter to President Johnson dated July 31, 1967, a copy of a letter to President Nixon dated March 9, 1974, and a copy of a letter to President Ford dated December 30, 1974.

For ten years now I have studied, thought, experimented and financed absolutely alone. I have purchased \$2,000. worth of books during this time concerning several fields; Astronomy, Physics, Chemistry, Medicine and they all have at their very base the same denominator, Electro Magnetic Energy.

Long ago I reasoned that (electric) magnetic fields must be the energy that makes up the material from which it comes. I am referring to a release of truly controlled atomic energy, with no potentially dangerous side effects to man or his environment. It has been a lonely feeling, realizing that what I see so clearly is unimaginable to most scientists.

I met Dr. Moragne in March, 1975, and we have talked frequently since that time. During this time I have forwarded him additional proof of my work on several occasions. The results of our talks brought about Dr. Moragne's letter. (2 pages of this recent information is in front of my 1975 document. Drawings are not enclosed, Neptune drawing is 12 feet, 11 inches long.)

It is obvious that the letter Dr. Moragne has written puts him in a position where he has nothing to gain and everything to lose.

Vice-President Rockefeller
Page two
August 28, 1975

I am sure you can appreciate my efforts, as I explained in the attached letter to President Ford dated December 30, 1974. That letter and all scientific correspondence ended up back at the National Science Foundation. A letter dated January 24, 1975, from H. Guyford Stever, Director of N.S.F., quoting mere scientific rhetoric is enclosed. My letter dated January 27, 1975, answering Mr. Stever's letter is also enclosed. The purpose of enclosing these two letters is to verify that I have found very few physicists qualified to even discuss the findings in my document. Add I feel that if you send my document to just anyone you may encounter the same. If you request Mr. Stever to give you all correspondence I sent to President Ford you will appreciate this statement.

The major point of all this, is that I am saying I can release an Unlimited Source of Energy from Electro-Magnetic Energy. This is simply using universal energy. This is basic, if man is to end all of his stupidity, hunger, greed, wars, disease, ageing, and advance to other solar systems! If there was one chance in one thousand that I was correct, it would still be the greatest return on an investment in the history of man. However, I have diligently sought to disprove my hypothesis for the last ten years, but over and over and over I have found proof that I was correct. So much so, that I state the mathematical odds of me being correct are phenomenal in my favor. I am at the point Edison was when he knew he could get light from electric current, but that he had to experiment to prove it.

I have found no one in the scientific community who could give exacting scientific argument against my findings. On the other hand, I have found a scientist of great proven ability that agrees with my findings and has obtained the interest of his colleagues.

Mr. Vice-President, I know that I have an ability that can be beneficial to mankind. Dr. Moragne has offered to help me. Will the government help me to help the government and the world?

It is in the interest of science and mankind that I ask for research money to be made available. I would appreciate your earliest possible reply concerning this most important matter.

Respectfully,

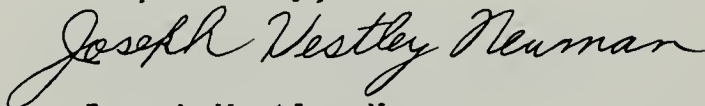

Joseph Westley Newman

JWN/en

Enclosures



OFFICE OF THE VICE PRESIDENT
WASHINGTON

February 19, 1976

Dear Mr. Newman:

This will acknowledge your letter to the Vice President regarding your interest and scientific proposal in the field of electro magnetic energy and request for financial assistance to enable you to further research your project.

The Vice President appreciates your interest and has instructed that your correspondence be forwarded to Dr. Robert C. Seamans, Administrator of the Energy Research and Development Administration, where it will be further reviewed and given appropriate action.

The Vice President thanks you for bringing this matter to his attention.

Sincerely,

A handwritten signature in black ink, appearing to read "Frank R. Pagnotta", with a long horizontal stroke extending to the right.

Frank R. Pagnotta
Assistant to the Vice President
for Administration

Mr. Joseph Westley Newman
1521 Deerwood Drive, East
Mobile, Alabama 36618

March 12, 1979

1521 Deerwood Drive, East
Mobile, Alabama 36618
Phone: (205) 344-9767

President Jimmy Carter
The White House
Washington, D. C.

Dear Mr. President:

This letter is written with the experienced knowledge that I will probably receive no responsible, exacting actions relative to this request. However, as I am a determined individual, because I have absolutely no doubt that I am correct, I persevere.

I can solve the energy problem as a result of 14 years of study, experimenting and deep creative thought! I have made my living solely as an inventor for the last 18 years. Science and Truth have been my major interest for the last 14 years.

Reference my credibility: Find enclosed 5 letters concerning my inventive ability (one of which is from the Governor of Alabama - Fob James, Jr.).

Find enclosed 7 letters from reputable scientific individuals which are complimentary of my scientific efforts. Two of these letters are from Dr. Robert E. Smith, Chief, Orbital and Space Environment Branch, Space Sciences Laboratory of NASA at Huntsville, Alabama. Dr. Smith's recent letter of February 26, 1979, describing the unexpected problem of getting exacting debate on my work of 14 years from some of his colleagues, outlines exactly, the typical scientific rhetoric I have received from the general scientific community for the last 12 years. (Studied and experimented for two years prior to seeking scientific debate).

Find enclosed copies of letters to Presidents of the past: President Johnson, July 31, 1967, President Nixon, March 9, 1974, President Ford, December 30, 1974, and to Vice-President Rockefeller, August 28, 1975. These letters explain in detail my efforts.

President Carter
Page two
March 12, 1979

As a result of these letters find enclosed copies of letters from National Science Foundation, Atomic Energy Commission, ERDA, other Department Heads of NASA, all saying they are unqualified to debate with me in an exacting, scientific manner on my scientific efforts. My letter of January 27, 1975 to Dr. Stever, (then) Director of National Science Foundation, explains my honest feelings of their scientific rhetoric.

In conclusion, I earnestly, again, ask the President of the United States to help me, help the people of my country and the people of all the world.

I can solve the energy problem! Find enclosed my scientific document that now consist of 92 pages of exacting, scientific statements, these statements are stated simply and clearly. There are no highly complicated mathematics or scientific rhetoric. I have studied, experimented and spent numerous hours in deep creative thinking during the last 14 years in compiling these scientific findings.

I earnestly request for you, President Carter, to demand the Federal Scientific Department Heads to all group together and agree or disagree in writing in an exacting, scientific manner to my 92 page scientific document. If all of these people are unqualified, as they say they are, to debate with me, then all of the major Universities in the U.S. be asked to prove me wrong. I also request for a board of individuals with high powers of reasoning be set up to review their written comments and my written comments in defense of my document.

If all of these people still claim they are unqualified to discuss exacting, scientific statements made simply, against what they have been taught, then it proves they do not truly understand what they have been taught.

Accordingly, President Carter, I ask that you then recognize that in itself is justification to give a Federal Grant to me so that I may complete my scientific efforts of 14 years (which I have financed solely alone) and release an Unlimited Source of Energy from Electromagnetic Fields of Force. I have read that you, Mr. President, are of scientific credibility. Please be advised that my scientific document is written so exacting, clearly and simply that you can read and understand what I have written.

President Carter
Page three
March 12, 1979

I know there are honest and credible scientists in every science field (such as Dr. Smith), but regrettably, that is the exception rather than the rule.

The future generations of this world and possibly other worlds, will be amazed at the scientific rhetoric and lack of Government Interest I have encountered and may still encounter in completing my scientific efforts, that will be of extreme benefit to this and all other generations.

For 14 years I have stood alone, against great odds. Must I continue to do so?

I would appreciate the earliest possible responsible reply.

Sincerely,

Joseph Westley Newman

JWN/en

Enclosures

November 17, 1983

Route 1, Box 52
Lucedale, Mississippi 39452
Phone: (601) 947-7147

President Ronald Reagan
The White House
Washington, D. C. 20025

Dear Mr. President:

This letter is written with literally years of experienced knowledge that I will probably receive no responsible, exacting actions relative to this request.

You will be the fifth President I have written regarding a New Source of Energy and the fifth President which I have asked to help me help the people of this country and the people of the world.

For over 18 years I have stood alone against a closed-minded scientific community and great odds.

My Government has given me absolutely no help, but to the contrary, has stood in my way and still continues to do so at the level of the U.S. Patent Office.

I now have several working prototypes of this New Energy Invention!

Please find enclosed copy of a letter I sent to President Johnson, dated July 31, 1967.

Also a copy of a letter, dated July 30, 1982, I sent to Mr. Paul Gomory (Expert Advisor on Patent Law for the Judiciary Committee of the Congress) and a copy of Mr. Gomory's reply to my letter which he sent to Mr. Ralph Oman, Staff Director, Criminal Law Subcommittee, Committee of the Judiciary.

Also find enclosed copy of my listing in the Physics Section of Who's Who In Technology, 1980 Edition, and numerous copies of letters from credible Scientific Individuals concerning

President Ronald Reagan
Page two
November 17, 1983

my scientific work, even before I built these prototypes, and which refers to a Scientific Document (Now 130 pages long), which puts forth a Unified Field Theory on all Matter. And copies of letters from credible business associates concerning my honesty and integrity and inventive ability.

Most important, find enclosed a VHS tape of news coverages made by Mr. Garland Robinette of WWL-Television (C.B.S.) of New Orleans. There are eight news coverages and one human interest coverage on this tape. Mr. Robinette has conducted himself in a most scientific manner relative to the facts on which he has reported, he has taken nothing for granted, but checked out all facts. Any others who give an opinion disagreeing on this matter, without doing equally as well, only reflect poorly on themselves and does an injustice to the peoples of the United States of America and the peoples of this world. I recommend that you view this tape before you pass this information down to some lower office as has always been the case in years past. This tape is approximately 30 minutes long.

My patent attorney is Mr. Emmett Pugh of New Orleans. Phone Area Code 504 - 581-2526.

Mr. Paul Gomory can be reached at Area Code 301-320-4327.

Mr. Robinette can be reached at Area Code 504-529-6300.

Patent Officials of U.S. Patent Office have deliberately ignored the requirements of the Patent Law Procedure relative to their own actions relative to the issuance of this Pioneering Patent on a New Energy Source.

I wish for the Commissioner of Patents to have to explain the actions of U.S. Patent Office, with me present, in front of the Judiciary Committee or the President.

I ask that you, Mr. President, have someone of honest integrity check out these facts in an exacting, scientific manner and to enact responsible actions accordingly.

I still stand alone, no doubt I will have to continue to do so, until all is accomplished as a result of my efforts. How sad that millions of others suffer in the mean time and the world stands on the threshold of total destruction.

President Ronald Reagan
Page three
November 17, 1983

This invention will be the cause of the Industrial Revolution all over again, except at a greatly accelerated rate, and will do more to reduce the possibility of war than any and all other means existing at this time, space travel will become a true reality, and will touch and excite all aspects of Science and will open many doors to the mind that have been closed before this time.

Sincerely,

A handwritten signature in cursive script that reads "Joseph Westley Newman". The signature is written in dark ink and is positioned above the printed name.

Joseph Westley Newman

JWN/en

Enclosures

THE WHITE HOUSE

WASHINGTON

March 21, 1984

Dear Mr. Newman:

On behalf of President Reagan, I want to thank you for your letter and enclosures.

The President appreciates the time you have taken to bring your invention to his attention. However, I am sorry that this must be a disappointing response to your request. So many similar requests are received that it just is not possible to comply. I hope you will understand.

With the President's best wishes,

Sincerely,

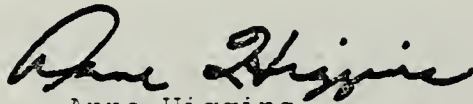

Anne Higgins

Special Assistant to the President
and Director of Correspondence

Mr. Joseph Westley Newman
Route 1, Box 52
Lucedale, MS 39452

VIDEO REVIEW

Name of Sender: Joseph W. Newman

ADDRESS: RT 1, Box 52 Lucedale, Miss 39452

Date Received by the White House: 11-21-83

DATE REVIEWED: 3-3-84 INITIALS OF VIEWER: GMK

VIDEO SENT TO: RR/NR/ WHO? R.R.

Summary: A new energy source - Electro -
magnetic device - John Stennis requested
funding - needs help to get US Patent
Some Scientists believe this invention
could change the world as it converts
mass into energy - runs on its own energy.
W.W.L TV - channel 4, New Orleans gave it
excellent coverage.

If nothing unusual send directly to Lillie Bell, Room 58. Make a copy for JCD's file.

✓ Special cases to Chuck Donovan, Room 94.

Problems, i.e. threats etc. send to Secret Service Room 45 via Bob Gallagher.

Keep original form with video.

Anything intended as a gift, i.e. a professional production, Bible tapes, send directly to the Gift Unit, Room 457.

SOUTHERN FASTENER CORPORATION

1641 CONCEPTION STREET ROAD
MOBILE, ALABAMA 36610

March 12, 1979

SUBJECT: Mr. Joe Newman the Man

Dear Sirs:

My business is manufacturing and distributing products for public use. Business for the past thirty years has enabled me to study and work with many groups of people.

Before any product can be produced someone with imagination, ingenuity, a lot of patience and determination must develop a useful and marketable item.

I have had the privilege of knowing several men who are scientist, physicist, or just inventors. Mr. Joe Newman is one of these men. I have known him about twelve years. During this time he has devoted his time, knowledge and energy to producing useful items for public service.

My impression has been from the beginning and remained constant through the years, that Mr. Newman has one objective foremost in all his actions. That objective has been and is to prove a theory and make it available to mankind which will provide and harness an abundant source of energy, which according to his theories and experiments is available to all mankind.

I am convinced he is honest, sincere and dedicated to his aims and is worthy of all considerations any individual can give.

This information and these opinions are written because I recognize the great, great need the world has for new energy sources and because I know the attitudes and dedications Mr. Newman has demonstrated through the years I have known him.

Sincerely,

Dennis A. Moore

Dennis A. Moore

SOUTHERN FASTENER CORPORATION

DAM/g

*Mr. Moore is also
Head of Mobile Water
Board and a director
of Mobile College.*

(205) 457-5382

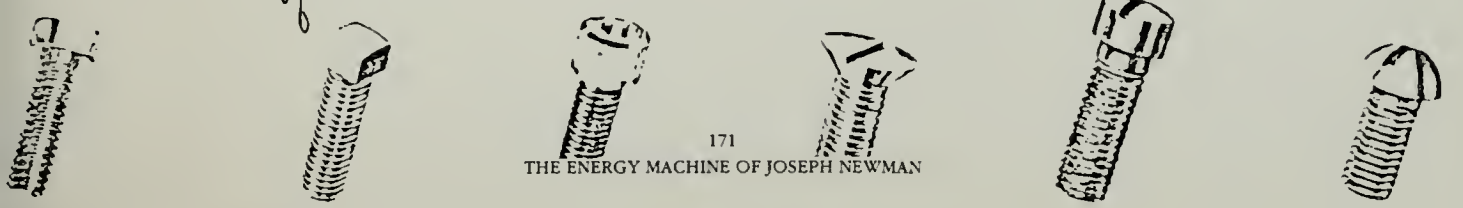



McConnell Cadillac, Inc.

P. O. DRAWER 16508 • 3060 DAUPHIN STREET

Mobile, Alabama 36616

TELEPHONE 205 • 471-6161

July 13, 1979

To Whom It May Concern:

I have had a business and personal relationship with Joe Newman for the past two years.

As a businessman, I can attest to his honesty and complete fairness in all of his business dealings.

From a standpoint of our personal relationship, I find him to be a very warm and considerate person of extreme honesty.

My overall opinion of Joe is that he has an extremely keen mind. Any subject or matter that he becomes interested in he will devote untold hours of study and research in his quest for the truth.

As an example, I know that he has spent years in his research to produce a source of unlimited energy. I personally believe that there is great merit to his findings. I only regret that I am not in a position to join him in the development of his research.

Sincerely yours,

J.V. McConnell, Pres.

July 1979

To Whom It May Concern:

I have known Joe Newman for about 29 years. During this period of time I have had the opportunity to discuss far reaching subjects from energy to economics. Joe Newman has always impressed me as being an honest and truthful man; more so than most of the people I know or have known.

For the past ten to twelve years I know that Joe has been involved with formulating theories concerning a source of unlimited energy. I have had the opportunity to discuss with him and read his theories and dissertations and for the most part they have been beyond my engineering practicum. However, I am impressed with what I understand with the theories and am acutely aware of this Nations energy dilemma. Therefore, I heartily recommend that Mr. Newman be given full leeway in exercising his theories for the sake of our Countrys future wellbeing.

Jim Wilson

Jim Wilson

Registered Professional Engineer

Mr. Wilson is a very capable engineer with the Ala. State Work Dept. and was the chief engineer in the building of the twin tunnel on I-10 under Mobile River.



MOBILE INHALATION THERAPY

POST OFFICE BOX 6712 • 166 LOUISELLE ST. • TELEPHONE 433-3905
MOBILE, ALABAMA 36606

October 6, 1977

TO WHOM IT MAY CONCERN:

I have known Joe Newman for the past eleven years. During this time we have developed a trusted business and personal relationship.

As a result of this relationship, I have been privileged to see him encounter numerous mechanical and scientific problems. Using his own creative ability he has developed solutions to each of these problems. More frequently than not, so quickly and simply that is has not only amazed me, but others who were specilists in the respective fields, including a number of individuals holding Masters, and P.H.D. degrees in engineering, science and mathematics.

With reference to Mr. Newmans character, from my own personal observations and others with whom we both have had contact, I find his honesty and integrity to be impeccable.

Most sincerely,

MOBILE INHALATION THERAPY

Ralston C. Reynolds
President and General Manager

RCR/md

JOHN B. CHANDLER COMPANY.



PAPER MILL SPECIALTIES

P.O. DRAWER 44
ATLANTIC BEACH
FLORIDA 32233
904-246-6711

October 4, 1977

Mr. Joe Newman
1521 Deerwood Dr. E.
Mobile, Alabama 36618

Dear Joe:

In days past we, the people at Scapa Dryers, Inc., have contacted you to help us with a problem that has been in existence for a long time. Your help in solving this problem through your inventive ability, which has been known to me for the past five years, made me confident enough (as you know) to recommend you to Scapa to help solve the dryer felt seam separation at each edge of the felt.

I am sure that the people at Scapa have your name on file and will be contacting you on any future mechanical problems. Thanks again for your help.

Best personal regards,

JOHN B. CHANDLER COMPANY

Pete A. Rodriguez

PAR:scm



309 williamson avenue
opelika, alabama 36801
ph: (205) 749-9001

diversified products corporation

September 29, 1977

TO WHOM IT MAY CONCERN:

I have known Joe Newman personally for 15 years during which time he has worked for us on numerous occasions as a trouble shooter of mechanical problems dealing with machinery and equipment from conceptual, design and production standpoints. Joe is the best I have ever seen in this regard with tremendous creative and inventive abilities.

Joe Newman is a man of integrity and complete honesty. I recommend him highly to find solutions for the tough and unusual mechanical problems of any nature.

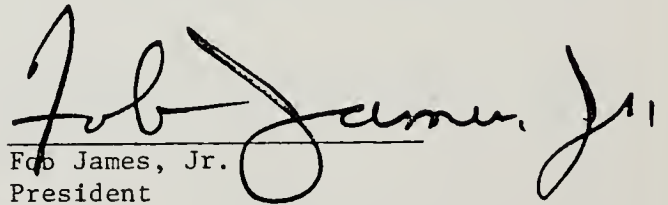
Joe James, Jr.
President



World's Largest Transmission Specialists

2525 FOWLER STREET, FT. MYERS, FLORIDA 33901 • (813) 334-7776

October 3, 1977

TO WHOM IT MAY CONCERN:

I have known Joe Newman, first professionally then personally, for over ten years. During this period, I have been continually amazed at his creativity and inventiveness towards mechanical problems and theory. When given a mechanical problem and objective, Newman will bring them together.

I have complete confidence in Joe Newman's ethics and honesty as well as his creative ability. As an engineer and mechanical businessman, it is not easy to impress me as Joe has.

Lindsey Burhans
Lindsey Burhans, President

In 1967, sent 25 page Scientific Document to all the 56 following colleges' Astronomy and Physics Departments:

COLLEGE	DEPT. HEAD OF PHYSICS	DEPT. HEAD OF ASTRONOMY
University of Alabama (Dr. Lear) Tuscaloosa, Alabama	1	
Stanford University Stanford, California	1	
University of California Berkeley 4, California	1	1
University of California Los Angeles, California	1	
California Institute of Technology 1201 East Calif. Street Pasadena 4, California	1	1
University of Southern California Los Angeles 7, California	1	
University of Colorado Boulder, Colorado	1	1
University of Connecticut Storrs, Connecticut	1	
Yale University New Haven, Connecticut	1	1
Catholic University of America Washington 17, D.C.	1	
Georgetown University Washington 7, D.C.	1	1
Florida State University Tallahassee, Florida	1	
University of Florida Gainesville, Florida	1	
Georgia Institute of Technology Atlanta 13, Georgia	1	
Illinois Institute of Technology Chicago 16, Illinois	1	
Northwestern University Evanston and Chicago, Illinois	1	1
University of Chicago Chicago 37, Illinois	1	1

COLLEGE	DEPT. HEAD OF PHYSICS	DEPT. HEAD OF ASTRONOMY
University of Illinois Urbana, Illinois	1	
Indiana University Bloomington, Indiana	1	1
Purdue University Lafayette, Indiana	1	
University of Notre Dame Notre Dame, Indiana	1	
Iowa State University of Science and Technology Amea, Iowa	1	
State University of Iowa Iowa City, Iowa	1	
University of Kansas Lawrence, Kansas	1	
Louisiana State University Baton Rouge 3, Louisiana	1	
Johns Hopkins University Baltimore 18, Maryland	1	
University of Maryland College Park, Maryland	1	
Harvard University Cambridge 38, Massachusetts	1	1
Massachusetts Institute of Technology Cambridge 39, Massachusetts	1	
Radcliffe College Cambridge 38, Massachusetts	1	1
Michigan State University East Lansing, Michigan	1	
University of Michigan Ann Arbor, Michigan	1	1
University of Minnesota Minneapolis, Minnesota	1	
Washington University St. Louis 30, Missouri	1	

COLLEGE	DEPT. HEAD OF PHYSICS	DEPT. HEAD OF ASTRONOMY
Princeton University Princeton, New Jersey	1	1
Rutgers - The State University New Brunswick, New Jersey	1	
Columbia University New York 27, New York	1	1
Cornell University Ithaca, New York	1	
New York University New York 3, New York	1	
University of Rochester Rochester 20, New York	1	
Duke University Durham, North Carolina	1	
University of North Carolina Chapel Hill, North Carolina	1	
Case Institute of Technology Cleveland 6, Ohio	1	1
Ohio State University Columbus 10, Ohio	1	
Carnegie Institute of Technology Pittsburg 13, Pennsylvania	1	
Pennsylvania State University University Park, Pennsylvania	1	
University of Pennsylvania Philadelphia 4, Pennsylvania	1	1
University of Pittsburg Pittsburg 21, Pennsylvania	1	
Brown University Providence 12, Rhode Island	1	
University of Tennessee Knoxville 16, Tennessee	1	
Rice University Houston 1 Texas	1	

COLLEGE	DEPT. HEAD OF PHYSICS	DEPT. HEAD OF ASTRONOMY
University of Texas Austin, Texas	1	
University of Utah Salt Lake City 12, Utah	1	
University of Virginia Charlottesville, Virginia	1	1
University of Washington Seattle 5, Washington	1	
University of Wisconsin Madison, Wisconsin	1	1



NATIONAL AERONAUTICS AND SPACE ADMINISTRATION
GEORGE C. MARSHALL SPACE FLIGHT CENTER
HUNTSVILLE, ALABAMA 35812

IN REPLY REFER TO:

PA

August 31, 1967

Mr. Joe W. Newman
3062 Pickell Drive
Mobile, Alabama 36605

Dear Mr. Newman:

Thank you for providing us with the opportunity of examining your communication concerning various scientific matters. In reading your document, we found it interesting and thought provoking.

With respect to your request for specific information about space rockets that have veered off course, please let me say that this information is not available at the Marshall Center. More than 600 space vehicles have been launched to date. Some of these launchings were conducted by civilian agencies and others by military organizations. Some were launched by Russia, France, England and Italy, as well as by the United States. So I am sure you can readily understand why the information you requested is not kept locally.

In the paper you forwarded to us you discuss a wide range of subjects, including magnetism, electricity, relativity, friction, celestial mechanics, gravity and means to achieve perpetual motion. In an effort to help you receive competent advice in the variety of areas you are interested in, and because we do not have experts in all of these fields, I suggest that you may wish to contact a special group that NASA Headquarters has established to receive and evaluate new proposals and ideas related to space research. It is the:

Board of Inventions and Contributions
NASA Headquarters
Washington, D. C. 20546

Again, let me say that we are glad that you are interested in our space program, and we appreciate your kindness in first submitting your ideas to us.

We wish you much success in your studies.

Sincerely yours,

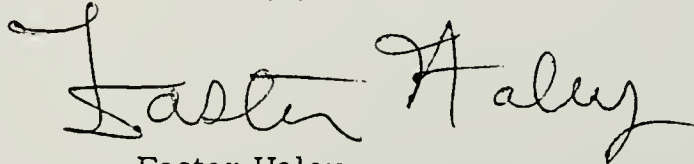
A handwritten signature in cursive script that reads "Foster Haley". The signature is written in dark ink and is positioned centrally on the page.

Foster Haley
Deputy Chief of Public Affairs

THE FLORIDA STATE UNIVERSITY

TALLAHASSEE 32306

DEPARTMENT OF PHYSICS

August 14, 1967

904

Mr. Joe W. Newman
3062 Pickell Drive
Mobile, Alabama 36605

Dear Mr. Newman:

I have read the document which you sent to the Physics Department.

It shows a great deal of imagination but also shows that you are unfamiliar with a vast amount of work which has been done and is being done in the fields of electro-dynamics and mechanics. I would strongly suggest that you read some standard texts in electricity and magnetism such as CLASSICAL ELECTRODYNAMICS by Jackson and INTRODUCTION TO ELECTROMAGNETIC FIELDS AND WAVES by Corson and Lorrain.

If you could then relate your work to the standard body of accepted and well tested physical theory it would have a much better chance of being heeded.

Sincerely,



Edward A. Desloge
Associate Professor

EAD:pw

1-904-385-3031

NATIONAL SCIENCE FOUNDATION

WASHINGTON, D.C. 20550

August 10, 1967

Mr. Joe W. Newman
3062 Pickell Drive
Mobile, Alabama 36605

Dear Mr. Newman:

President Johnson has referred your letter of July 31, 1967 to the National Science Foundation for reply. The Foundation is a Federal agency whose principal mission is support of basic research and education in the sciences. I would like to thank you on behalf of the President for bringing your thoughts on scientific matters to the attention of the Government.

I have referred your paper to the Physics Section of our Mathematical and Physical Sciences Division for further review. You may expect to hear from them after they have had an opportunity to study it.

Sincerely yours,

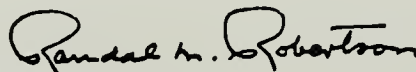

Randal M. Robertson
Associate Director (Research)

THE PHYSICAL REVIEW
AND
PHYSICAL REVIEW LETTERS

(PUBLISHED FOR THE AMERICAN PHYSICAL SOCIETY, S.A. GOUDSMIT, MANAGING EDITOR)

BROOKHAVEN NATIONAL LABORATORY, UPTON, LONG ISLAND, NEW YORK 11973

AREA CODE 516, YAPHANK 4-6262, EXT. 2341

The Physical Review

S. PASTERNAK, Editor
A. HERSCHMAN, Editor (on leave)
A.W.K. METZNER, Acting Editor
J.C. FINEMAN, Assistant to the Editors

Physical Review Letters

S.A. GOUDSMIT, Editor
G.L. TRIGG, Editor
M.J. FLEMING, Publication Manager

18 April 1967

Dr. Joe W. Newman
General Delivery
Webster, Texas

Dear Dr. Newman:

We regret to inform you that your manuscript "The Universe" is not considered suitable for publication in The Physical Review. We are therefore returning it herewith.

Yours sincerely,



SP:cc
Enc.

S. Pasternack
Editor

UNIVERSITY OF CALIFORNIA, BERKELEY

BERKELEY • DAVIS • IRVINE • LOS ANGELES • RIVERSIDE • SAN DIEGO • SAN FRANCISCO



SANTA BARBARA • SANTA CRUZ

DEPARTMENT OF PHYSICS

BERKELEY, CALIFORNIA 94720

August 24, 1967

Mr. Joe W. Newman
3062 Pickell Drive
Mobile, Alabama 36605

Dear Mr. Newman:

This is simply a note to acknowledge receipt of your document regarding the laws of electricity and magnetism.

Thus far no one on the faculty has given it a critical review. If we find it desirable to communicate further with you, you may be assured that we will do so upon the earliest occasion of interest.

Sincerely yours

Burton J. Moyer
Chairman

bjm:mlm

DEPARTMENT OF ASTRONOMY
HARVARD UNIVERSITY
60 GARDEN STREET
CAMBRIDGE, MASSACHUSETTS 02138

7 August 1967

Mr. Joe E. Newman
3062 Pickell Drive
Mobile, Alabama 36605

Dear Mr. Newman:

This is in regard to the Scientific Document which we received from you today along with your request for comments.

Unfortunately your request has come at a very bad time of the year and I am sorry to say that the members of our staff who could review your document are not generally available during the summer months. I am therefore returning your paper with the hope that you will be able to find someone who could give more prompt attention to your request.

Sincerely yours,

Ruth Mandalian

Ruth Mandalian
Administrative Secretary

RM:sw

Enclosures

P.S. Since Radcliffe College does not have a separate astronomy department, the document which you sent them has been forwarded to us, and is also enclosed.

UNIVERSITY OF COLORADO
BOULDER, COLORADO 80302

August 8, 1967

Mr. Joe W. Newman
3062 Pickell Drive
Mobile, Alabama 36605

Dear Mr. Newman:

We in the Department of Physics and Astrophysics receive so many letters, pamphlets, and books that it is impossible for us to acknowledge each one individually. I therefore want to acknowledge your writing by means of this form letter.

Sincerely,

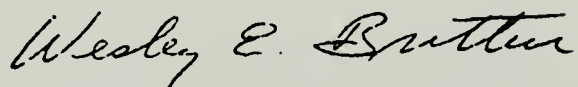

Wesley E. Brittin
Chairman

WEB/j

NORTHWESTERN UNIVERSITY

EVANSTON, ILLINOIS 60201

DEPARTMENT OF PHYSICS

August 14, 1967

Mr. Joe W. Newman
3062 Pickell Drive
Mobile, Alabama 36605

Dear Mr. Newman:

I have just received your 25 page Scientific Document which you sent me August 3, 1967. I will try to see if anyone here is interested in your work and will send any comments to you.

Sincerely yours,



Arthur J. Freeman
Chairman

AJF:eh

UNIVERSITY OF ALABAMA
UNIVERSITY, ALABAMA 35486

COLLEGE OF ENGINEERING
OFFICE OF THE DEAN

October 11, 1967

Mr. Joe W. Newman
3062 Pickell Drive
Mobile, Alabama 36605

Dear Mr. Newman:

I apologize for the long delay in responding to your request for my opinion on your document relating to the LAWS OF MAGNETISM AND ELECTRICITY GOVERNING THE MOVEMENT OF BODIES IN THE UNIVERSE. Since my area of specialty is electromagnetic theory, I must disqualify myself as an expert in astrophysics, and suggest that it would be more appropriate if you would consult a specialist in this area. Perhaps someone in the Physics Department of the University of South Alabama would be willing to give his opinion on your work. I must confess to considerable satisfaction personally with the laws of Kepler, Newton and Einstein as they have been applied by engineers and scientists to predict the motion of bodies in space, including the motion of free charged particle in high vacuum. It is very difficult, too, to argue with the success that has been evident in our various space probes.

In any event, all of these laws are only models which we use to attempt to explain what happens in nature, but they don't tell us why these things happen. For example, in your discussions you use the terms, "magnetic flux" and "magnetic lines of force" many times to explain the actions of bodies in motion. As I'm sure you will agree, there is no such thing as a magnetic line of force, this being simply a model which is used to attempt to explain something which happens. The key question, it seems to me, is why do we have this thing which we call "magnetic force" when two charged particles are in motion relative to one another. It is the attempt to answer questions such as this that present us with what I feel are our most intriguing fields of inquiry.

Again, thank you for letting me read your document and I am sorry I do not feel qualified to comment on the points at which you feel you are in disagreement with existing theory.

Sincerely yours,

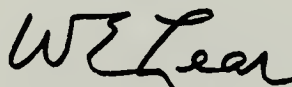

W. Edward Lear
Dean

WEL:vk

cc: Mr. John Tyson

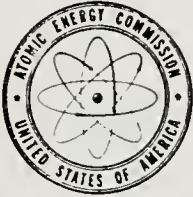

UNITED STATES
ATOMIC ENERGY COMMISSION
WASHINGTON, D.C. 20545

JAN 21 1960

Mr. Joe W. Newman
3062 Pickell Drive
Mobile, Alabama 36605

Dear Mr. Newman:

It was nice to talk with you and Mr. Giddens a few days ago on the phone and to receive your letter of January 7 and its two attachments, namely:

Article from Mobile Press Register, "What is Gravity?"
Manuscript, "For the sake of mankind and in the interest of science."

When I got the material I sent it to members of our scientific staff for review. They examined it and returned it promptly to me without making any substantive comments. They did point out so far as the Atomic Energy Commission is concerned the documents discuss matters outside our purview.

The impression I have from my examination is that your material, while interesting to read, is based on a general philosophical approach to the universe rather than on a detailed account of nature and its interrelationships.

You told me on the phone that you were having difficulty finding someone to publish your material. This is not surprising for really there are very few philanthropic individuals or organizations set up to finance the cost of publishing documents such as yours. Many scientific societies (for example the American Physical Society) even assess page charges to the authors of papers published in their journals. They are even highly selective in the actual documents in their journals because the members of the societies have their own ideas on what they want to preserve by publication.

Thanks for giving me the opportunity to examine the enclosed documents. I hope you find my remarks helpful, that certainly is my intent. Please give my very best regards to Mr. Giddens.

Sincerely yours,

A handwritten signature in cursive script that reads "Paul W. McDaniel".

Paul W. McDaniel, Director
Division of Research

Enclosures:
Two documents noted above.



VOICE OF AMERICA
UNITED STATES INFORMATION AGENCY
WASHINGTON, D.C. 20547

November 9, 1970

Dear Joe:

Please mail a copy of your Moon article to
Dr. Velikovsky, 78 Hartley Avenue, Princeton,
New Jersey 08540. Thought it might interest him.

Hope your affairs are going well.

Sincerely,

A handwritten signature in cursive script, appearing to read "Kenneth R. Giddens", with a long horizontal line extending to the right.

Kenneth R. Giddens
Director

Mr. F. J. Newman, Jr.
1454 Government Street
Mobile, Alabama

MANUEL VELIKOVSKY
72 HARTLEY AVENUE
SPRINGTOWN, N.J. 08540

Nov. 30.70

Dear Mr Newman:

I have received your typescript. Being at this time greatly pressed by urgent work I could only cursorily read it. It contains quite a few themes discussed by me partly in print and partly in correspondence. I shall take the liberty of mailing it to a friend and ask him to express his opinion.

But title your paper "For the Sake of Mankind and in the Interest of Science" You do not display the proper taste and outpoison any scientist before he may have the chance to look into the content of your paper.

Very sincerely yours,
M. Velikovsky

DR. MANUEL VELIKOVSKY
72 HARTLEY AVENUE
SPRINGTOWN, N.J. 08540

NATIONAL ACADEMY OF SCIENCES

OFFICE OF THE PRESIDENT
2101 CONSTITUTION AVENUE
WASHINGTON, D. C. 20418

August 5, 1974

PERSONAL

Mr. Kenneth R. Giddens, Director
Voice of America
U.S. Information Agency
Washington, D. C. 20547

Dear Ken:

Referring to your personal letter of July 9, I really do not feel that Mr. Newman has achieved any new insights or notable experimental results, nor that his conclusions would withstand detailed scrutiny in the light of facts that have been irrefutably established by long and painstaking investigations.

Of course, the standard procedure for scientific publication would involve his first sending his paper to the editor of an appropriate scientific journal. If the editor felt that the paper might have any substantial merit, he would normally have it read by two or three highly qualified scientists in relevant fields, who would recommend for or against its acceptance for publication.

Mr. Newman can find a wide selection of scientific journals in any good university library, and can himself determine which he thinks closest to his interests.

To you, however, I should make it clear that I hold out no hope that his ideas would be found to embody anything publishable.

PERSONAL

Mr. Kenneth R. Giddens, Director
August 5, 1974
Page Two

Woods Hole does have its advantages over Washington, whether one is vacationing or working here, or, as I am, doing both. Do come this way and try it out.

With best regards.

Sincerely yours,

A handwritten signature in cursive script that reads "Phil".

Philip Handler
President

NATIONAL SCIENCE FOUNDATION

WASHINGTON, D.C. 20550

June 18, 1974

Mr. Joe W. Newman
1541 Bracher Drive
Houston, Texas 77055

Dear Mr. Newman:

Thank you for your letter of June 1, 1974. It is not my conclusion that your experiment on the "speed and paths of objects in their orbits" would necessarily be decisive, since there might be alternative explanations for the phenomena observed. If your theory is to gain support, it will only be through publication of your experimental results in one of the reputable journals.

Incidentally, the Foundation does not support publication by non-NSF grantees.

Sincerely yours,

A. Bridgewater

Albert Bridgewater
Staff Assistant
Physics Section



NATIONAL AERONAUTICS AND SPACE ADMINISTRATION
WASHINGTON, D.C. 20546



REPLY TO
ATTN OF

June 18, 1974

Mr. Joe W. Newman
1541 Bracher Drive
Houston, Texas 77055

Dear Mr. Newman:

Your letter to the President concerning magnetic and electrical fields has been referred to my office for reply.

The National Aeronautics and Space Administration, in supporting the National energy program, welcomes the opportunity to consider recommendations which may lead to the early and effective application of additional energy sources. Your letter has been passed to our technical staff for consideration. Should additional information be desired you will be contacted directly.

Thank you for your interest and your effort in this vital issue.

Sincerely,

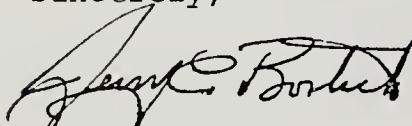
for 
Harrison H. Schmitt

Assistant Administrator for
Energy Programs

No Further Comment



NATIONAL AERONAUTICS AND SPACE ADMINISTRATION
LYNDON B. JOHNSON SPACE CENTER
HOUSTON, TEXAS 77058

REPLY TO
ATTN OF:

CB

April 24, 1974

Mr. Joe W. Newman
1541 Bracher Drive
Houston, TX 77055

Hello Joe:

Thanks for the water see-saw. The kids had a lot of fun.
The water was too cold for me. Ha!

Your plans on the torso trimmer are enclosed. We only have
one more flight until Shuttle, and we don't plan to change
our exercise machine for this flight. It also looks like it
would have to be modified to be useful and lighter for space
flight. Maybe when the time comes we can use it on Shuttle
flights.

A copy of your continuation of hypothesis is enclosed with my
comments. I hope you can expand your creative ideas so that
they can help explain some more of the quote "scientifically
accepted and proven theories" of magnetism and gravity.

Best personal regards till we meet again.

Sincerely,

Ronald E. Evans
Captain, USN
NASA Astronaut

Enclosures

*Capt. Evans has orbited
the moon.*



UNITED STATES
ATOMIC ENERGY COMMISSION
WASHINGTON, D.C. 20545

MAR 14 1974

Mr. Joe W. Newman
1541 Bracher Drive
Houston, Texas 77055

Dear Mr. Newman:

Thank you for your letter of March 8, 1974, concerning articles you plan to send to the scientific community.

The Atomic Energy Commission does not undertake any direct evaluation of independent scientific treatises because the vast number of such independent researches carried out in the world today has made it necessary for all fundamental scientific work to undergo an evaluation by the scientific community.

Thank you for sharing your thoughts with us. We wish you success in your future publication efforts.

Sincerely,

A handwritten signature in black ink that reads "D. R. Miller".

D. R. Miller, Deputy Director
Division of Physical Research

P.S. You may be interested to learn that since your last correspondence, Dr. P. W. McDaniel has retired from the AEC.



UNITED STATES
ATOMIC ENERGY COMMISSION

WASHINGTON, D.C. 20545

MAY 21 1974

Mr. Joe W. Newman
1541 Bracher Drive
Houston, Texas 77055

Dear Mr. Newman:

I have looked at the material you submitted with your letter of May 15, 1974, and have reviewed again our previous correspondence. I am afraid that my conclusion is that I have nothing to add to my previous statements and suggestions.

Your persistence is understandable, for your objective of convincing the scientific community of the correctness of your hypothesis requires it. Have you discussed your ideas with working scientists specializing in the areas in which you are concerned?

Sincerely,

A handwritten signature in black ink that reads "D. R. Miller". The signature is written in a cursive style with a long, sweeping underline.

D. R. Miller, Deputy Director
Division of Physical Research

FEDERAL ENERGY OFFICE
WASHINGTON, D.C. 20461

MAY 20 1974

Mr. Joe W. Newman
1541 Bracher Drive
Houston, Texas 77055

Dear Mr. Newman:

Thank you for your recent letter to President Nixon concerning energy research and development that has been suggested as having the potential to contribute to an easing of the energy situation.

Because the National Aeronautics and Space Administration has special expertise in this matter, I am forwarding your letter to their office for consideration.

For your information, I am enclosing an energy research and development fact sheet, an energy definitions list that appeared in the Congressional Record, and an enumeration of energy research and development budget recommendations for fiscal year 1975 that may be of interest to you.

Sincerely,

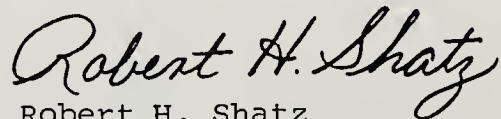

Robert H. Shatz
Assistant Administrator
Energy Resource Development

Enclosures

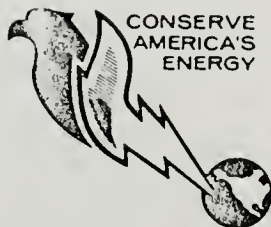

Save Energy and You Serve America!

NATIONAL SCIENCE FOUNDATION

WASHINGTON, D.C. 20550

MAY 13 1974

Mr. Joe W. Newman
1541 Bracher Drive
Houston, Texas 77055

Dear Mr. Newman:

Your letter of March 29, 1974 addressed to President Richard M. Nixon, together with a copy of your paper on "Hypothesis that the Word 'Gravity' is the Effect of Magnetic and Electric Fields of Force," has been referred to this office for a scientific reply.

An identical letter was received by the Assistant Director for Research, National Science Foundation, Washington, D.C. Therefore, a copy of the Foundation's reply to your letter, dated April 30, 1974, is transmitted herewith.

Sincerely yours,

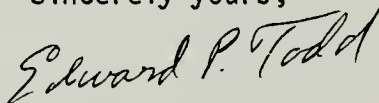

Edward P. Todd
Deputy Assistant Director
for Research

Enclosure

NATIONAL SCIENCE FOUNDATION

WASHINGTON, D.C. 20550

April 30, 1974

Mr. Joe W. Newman
1541 Bracher Drive
Houston, Texas 77055

Dear Mr. Newman:

Thank you for your letter of March 29, 1974. Since we have no record of having received your March 5, 1974 letter, I will only comment on the material included in pages 17-22 of your document.

Your theory does not appear to challenge the validity of calculations based on the accepted theories. Therefore, the test of your theory is whether it predicts any previously undetected phenomena. The hypothesized negatively and positively charged energy particles would satisfy this criterion, but these particles have not been observed in any of the many experiments in which charged particle detectors have been placed in magnetic fields. Because alternative explanations are possible, attraction of the graphite rod toward your finger is not conclusive evidence for the existence of charged energy particles.

In conclusion, your theory reformulates but not supplants existing concepts.

Sincerely yours,

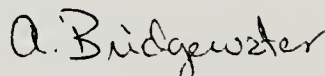

Albert Bridgewater
Staff Assistant
Physics Section



NATIONAL AERONAUTICS AND SPACE ADMINISTRATION
LYNDON B. JOHNSON SPACE CENTER
HOUSTON, TEXAS 77058

REPLY TO
ATTN OF: TN7

March 13, 1974

J. W. Newman
1541 Bracher Drive
Houston, TX 77055

Dear Mr. Newman:

Thank you for your manuscript, "Magnetic and Electrical Fields..." I have found it stimulating. Unfortunately most of it is beyond my field of expertise and thus I am unable to evaluate your contribution.

Thus I have taken the liberty of sending the manuscript to a colleague - Prof. G. W. Pearce of the University of Toronto. He is a geophysist and specialist in magnetics.

Yours truly,

Richard J. Williams

TN7:RJWilliams:ceh:3/13/74

*No comment ever received
from Prof. Pearce*



NATIONAL AERONAUTICS AND SPACE ADMINISTRATION
LYNDON B. JOHNSON SPACE CENTER
HOUSTON, TEXAS 77058

REPLY TO
ATTN OF: AC

APR 17 1974

Mr. Joe W. Newman
1541 Bracher Drive
Houston, Texas 77055

Dear Mr. Newman:

In reply to your letter of April 8, 1974, I have discussed your paper with Dr. Brett. It is my understanding that he is forwarding a reply to you recommending that you contact the Journal of Geophysical Research. I believe that since this Center really does not have the specialists in those fields that would be appropriate to evaluate your hypothesis, it would be better to forward your paper to them for possible review and publication.

Sincerely,

George W. S. Abbey
Technical Assistant to the Director

JOURNAL OF GEOPHYSICAL RESEARCH
SPACE PHYSICS

PUBLISHED BY THE AMERICAN GEOPHYSICAL UNION

GEORGE C. REID, EDITOR

AERONOMY LABORATORY

NATIONAL OCEANIC & ATMOSPHERIC ADMINISTRATION

BOULDER, COLORADO 80302

TELEPHONE: 303 - 494-4737

May 23, 1974

Mr. Joe W. Newman
1541 Bracher Drive
Houston, Texas 77055

Dear Mr. Newman,

Thank you for your letter of 15 May enclosing a copy of your manuscript. Unfortunately the topic of your paper lies well outside the range covered by the Space Physics section of the Journal of Geophysical Research. We are restricted essentially to papers dealing with experimental and theoretical studies of the physics and chemistry of the upper atmosphere and near space, and we cannot handle papers on such basic subjects as the connection between gravity and magnetic fields.

Subject matter aside, however, I think you will have great difficulty in having your paper published in any scientific journal in its present form. There is a generally accepted format for scientific papers, and unfortunate as it may be one has to speak the scientists' language to communicate effectively with them. It may be helpful to consult a few current scientific journals, and to see whether you can re-cast your presentation to conform generally with their normal style. This will at least ensure that your paper is given serious consideration, and is not rejected out of hand with a polite form letter.

With best wishes.

Sincerely,

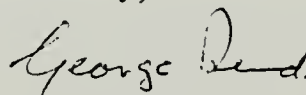

George C. Reid

Enclosure

University of Maryland
702-784-6454

Editor-in-Chief
S.A. GOUDSMIT

The Physical Review

Editors
S. PASTERNAK
P.D. ADAMS
H.H. BARSCHALL
C.L. SNEAD JR.

Physical Review Letters

Editors
S.A. GOUDSMIT
GEORGE L. TRIGG
Publication Manager
M.J. FLEMING

THE PHYSICAL REVIEW AND PHYSICAL REVIEW LETTERS

(PUBLISHED FOR THE AMERICAN PHYSICAL SOCIETY)

BROOKHAVEN NATIONAL LABORATORY, UPTON, LONG ISLAND, NEW YORK 11973

Telephone (516) 345-2540

24 April 1974

Dr. Joe W. Newman
1541 Bracher Drive
Houston, Texas 77055

Dear Dr. Newman,

We regret to inform you that your manuscript "Magnetic and Electrical Fields, not just the Word Gravity, are Key Factors in Controlling the Movement of the Earth, Moon, Planets, Sun, Stars and Galaxies throughout the Universe" is not considered suitable for publication in The Physical Review. We are therefore returning it herewith.

Yours sincerely,

C. Lewis Snead, Jr.
Editor

bs
Enc.

NATIONAL SCIENCE FOUNDATION
WASHINGTON, D C 20550



nsf

OFFICE OF THE
DIRECTOR

January 24, 1975

Mr. Joseph Westley Newman
1521 Deerwood Drive, East
Mobile, Alabama 36618

Dear Mr. Newman:

We have received your letter of December 30, 1974 which you sent to President Ford regarding unlimited sources of energy from magnetic and electric fields of power source. In reviewing the correspondence, we see that you had forwarded a similar letter to President Nixon on March 29, 1974 and that letter was referred to the National Science Foundation for response by Dr. Todd and Dr. Bridgewater.

We appreciate your sincerity but you must recognize that the answers which we supplied six months ago still represent the viewpoint of the National Science Foundation.

During May and June of 1974, Dr. Bridgewater tried at great length to provide what I consider to be a fair examination of your hypothesis and has suggested publication of your theories and experimental results in reputable journals in order to resolve any differences in viewpoint. Dr. Bridgewater made other suggestions to you which I am sure you have as a result of the previous correspondence.

Certainly creative and innovative thinking is always encouraged. I would suggest that you take the advice in the impartial manner that it is provided and concentrate upon publication of your theories, development of the experimental data, and detailed discussions to resolve divergent viewpoints.

We strongly support the free and open exchange of scientific information. If your document has the necessary scientific foundation, I am reasonably confident that publication would not be a major obstacle.

Sincerely yours,

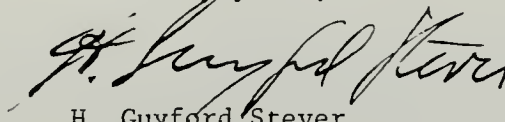

H. Guyford Stever
Director

January 27, 1975

1521 Deerwood Drive, East
Mobile, Alabama 36618
Phone: 205-344-9767

Mr. H. Guyford Stever, Director
NATIONAL SCIENCE FOUNDATION
Washington, D. C. 20550

Dear Mr. Stever:

Reference your letter of January 24, 1975. It was not my intention that the National Science Foundation receive my letter, documents and correspondence forwarded to President Ford.

Your response is exactly what I would have expected, had I sent it to your department.

Dr. Bridgewater's correspondence was polite, but not exacting scientific argument. And contrary to what you and Dr. Bridgewater suggest, publication in a reputable journal is a major problem. This is even admitted by Mr. Reid of the Journal of Geophysical Research in his letter of May 23, 1974, of which you have a copy.

The scientific community is now and has always been made up majorly of individuals who have memorized the works of great men before them and therefore, claim to be true scientists. Their claim is ridiculous and their close-mindedness is despicable.

I do not make this comment based off my experiences with the so called scientific community. History is full of the disheartening experiences of great men who were ridiculed by the scientific community of their time and even their colleagues. Robert Goddard is an example. The Germans were amazed at the American Government's lack of interest in Goddard's work. He died in 1945. It was not until 1960 that the U.S. acknowledged his contribution with an award of one million dollars to his estate for the use of his patents. That was a great help after he was dead!

The so called scientific community of the U.S. is now quick to say, "look what we have done, sent men to the moon." Only men of vision like Goddard and Von Braun have caused men to be sent to the moon.

I have tried diligently and politely to get exacting scientific argument on what I have written. I have not received it. If I am wrong, it should be a simple matter for the National Science Foundation, with all its knowledgeable scientists, to prove me wrong. Not to be able to do so shows the lack of ability to creatively think!

Mr. Stever
Page two
January 27, 1975

What I am saying is simple. There is no such thing as a third entity called Gravity. There is only the observance of Electrical and Magnetic Fields of Force. I challenge anyone to quote factual experiments to prove me wrong.

If there is no one there with the power of reasoning to prove me wrong, that in itself is reason for your department to send it to someone who can; or that your department request one of the reputable journals to publish my article for the purpose of having it reputed.

The scientific community is like a boxer or athlete who claims to be the greatest, but will not compete.

I have gotten no warm and satisfying feeling from writing this letter. I ask that you be honest with yourself for a moment. What would you have written, if you were me and had tried as I have tried, to get someone to debate with you to the finish?

Regrettably,

A handwritten signature in cursive script that reads "Joseph Westley Newman". The signature is fluid and extends across the width of the text area.

Joseph Westley Newman

JWN/en

NATIONAL SCIENCE FOUNDATION

WASHINGTON, D.C. 20550

APR 8 1975

Mr. Joseph Westley Newman
1521 Deerwood Drive, East
Mobile, Alabama 36618

Dear Mr. Newman:

We have enjoyed corresponding with you during these past few months but our advice is still the same. The proper place for your ideas to be exposed and to obtain reactions from your colleagues is for you to publish them in a reputable periodical. If your ideas are as sound as you profess, these periodicals would welcome your document, and publication would stimulate discussion throughout the scientific community.

I feel that this is the most effective step for you to take and recommend that your energies be focused in that direction.

Sincerely yours,



William H. Wetmore
Director
Office of Public
Technology Projects
Research Applications

MORAGNE RESEARCH & DEVELOPMENT CO.

6230 Evergreen Suite "E"

Houston, Texas 77036

713 - 772-4668

August 7, 1975

Mr. Joseph Westley Newman
1521 Deerwood Drive, East
Mobile, Alabama 36618

Dear Joe:

In reading your report, drawings and calculations, it is my opinion your work on Magnetic and Electrical Fields of Force shows scientific promise. It requires someone with inexhaustible creative ability in the science of physics and astronomy to make the discovery and be able to express as you have. But, you have opened an area in Astrophysics which may revolutionize the magnetic energy problem which is now the most paramount problem in future energy and space travel. This, we will explore further after you set up your research program.

I do believe with proper research funds (and do not start off under-financed), the results would not only be a great financial boom to your financiers, but would lead to developments that will be practical and beneficial to all mankind and develop a new step in science.

As a matter of fact, I, and other scientists in the scientific community in the aerospace science group here in Houston, will be more than willing to collaborate and assist you in this very important endeavor with particular emphasis on this unlimited source of energy.

Please let me know if I can be of any service to you.

Sincerely yours,

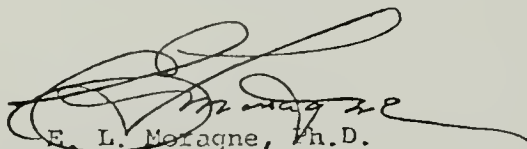

E. L. Moragne, Ph.D.

ELM:gs

Dr. Moragne holds patent on electro-magnetic process making first Atomic bomb possible. He is listed in American Men + Women of Science, 12th Edition, page 4374.

JOHN C. STENNIS, MISS., CHAIRMAN
STUART SYMINGTON, MO.
HENRY M. JACKSON, WASH.
HOWARD W. CANNON, NEV.
THOMAS J. MCINTYRE, N.H.
HARRY F. BYRD, JR., VA.
SAM NUNN, GA.
JOHN G. CULVER, IOWA
GARY HART, COLO.
PATRICK J. LEAHY, VT.
T. EDWARD ERPSWELL, JR., CHIEF COUNSEL AND STAFF DIRECTOR

STROM THURMOND, S.C.
JOHN TOUVER, TEX.
EARLY GOLOWATER, ARIZ.
WILLIAM L. SCOTT, VA.
ROBERT TAFT, JR., OHIO
DWAYNE F. BARTLETT, OKLA.

United States Senate

COMMITTEE ON ARMED SERVICES

WASHINGTON, D.C. 20510

August 23, 1976

Honorable Robert C. Seamans, Jr., Administrator
Energy Research and Development Administration
20 Massachusetts Avenue
Washington, D.C. 20545

Dear Doctor Seamans:

I am enclosing herewith some correspondence and newspaper clippings relating to a development in the energy field by Mr. Joseph W. Newman, 1521 Deerwood Drive, East, Mobile, Alabama 36618.

It appears from the file that several experts feel that his report, drawings and calculations have considerable scientific promise, and I am writing this to recommend very strongly that he be considered for an energy research grant by ERDA.

I realize that you will need the specifics of his proposal in order to give the matter proper consideration. I am sure you can obtain these by contacting Mr. Newman at the address given above.

Your early attention to this will be appreciated.

Sincerely,

JOHN C. STENNIS
United States Senator

JCS:cls
Enclosures: a/s



UNITED STATES
ENERGY RESEARCH AND DEVELOPMENT ADMINISTRATION
WASHINGTON, D.C. 20545

SEP 7 1976

Honorable John C. Stennis
United States Senate

Dear Senator Stennis:

Dr. Seamans has asked me to reply to your letter of August 23, 1976, concerning Mr. Joseph W. Newman.

We have had correspondence with Mr. Newman dating back to 1969, and we have suggested that he publish his work in a reputable technical journal. In the correspondence forwarded with your letter, Mr. Smith of NASA makes the same recommendation, affirming our belief that such publication is the appropriate next step for Mr. Newman.

I wish that we could be more helpful in this matter.

Sincerely,

James S. Kane, Director
Division of Physical Research



JOHN C. STENNIS, MISS., CHAIRMAN

STUART SYMINGTON, MD.
HENRY M. JACKSON, WASH.
HOWARD W. CANDON, NEV.
THOMAS J. MCINTYRE, N.H.
HARRY F. BYRD, JR., VA.
SAM NUNN, GA.
JOHN C. CULVER, IOWA
GARY HART, COLO.
PATRICK J. LEAHY, VT.

STROM THURMOND, S.C.
JOHN TOWER, TEX.
BARRY GOLDWATER, ARIZ.
WILLIAM L. SCOTT, VA.
ROBERT TAFT, JR., OHIO
DEWEY F. BARTLETT, OKLA.

T. EDWARD BRASWELL, JR., CHIEF COUNSEL AND STAFF DIRECTOR

United States Senate

COMMITTEE ON ARMED SERVICES

WASHINGTON, D.C. 20510

October 28, 1976

Mr. Joseph W. Newman
1521 Deerwood Drive, East
Mobile, Alabama 36618

Dear Joseph:

I have your letter of October 23rd and have read it with a great deal of interest. I shall certainly give the points you raise my attention.

In the meantime, I urge you to persist in this matter. I again express my regrets that the contacts I made on your behalf were not more productive.

With warm personal regards, I am

Your friend,

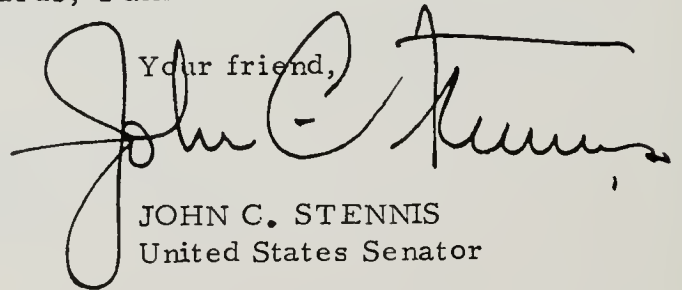

JOHN C. STENNIS
United States Senator

JCS:cls

OLIN E. TEAGUE, TEX., CHAIRMAN

KEN HECHLER, W. VA.
THOMAS N. DOWNING, VA.
DON FUQUA, FLA.
JAMES W. SYMINGTON, MO.
WALTER FLOWERS, ALA.
ROBERT A. ROE, N.J.
MIKE MC CORMACK, WASH.
GEORGE E. BROWN, JR., CALIF.
DALE MILFORD, TEX.
RAY THORNTON, ARK.
JAMES H. SCHEUER, N.Y.
RICHARD L. OTTINGER, N.Y.
HENRY A. WAXMAN, CALIF.
PHILIP H. HAYES, IND.
TOM HARKIN, IOWA
JIM LLOYD, CALIF.
JEROME A. AMBRO, N.Y.
CHRISTOPHER J. DOOD, CONN.
MICHAEL T. BLOUIN, IOWA
TIM L. HALL, ILL.
ROBERT KRUEGER, TEX.
MARILYN LLOYD, TENN.
JAMES J. BLANCHARD, MICH.
TIMOTHY E. WIRTH, COLO.

CHARLES A. MOSHER, OHIO
ALPHONZO BELL, CALIF.
JOHN JARMAN, OKLA.
JOHN W. WYDLER, N.Y.
LARRY WINN, JR., KANS.
LOUIS FREY, JR., FLA.
BARRY M. GOLDWATER, JR., CALIF.
MARVIN L. ESCH, MICH.
JOHN B. CONLAN, ARIZ.
GARY A. MYERS, PA.
DAVID F. EMERY, MAINE
LARRY PRESSLER, S. DAK.

COMMITTEE ON SCIENCE AND TECHNOLOGY
U.S. HOUSE OF REPRESENTATIVES
SUITE 2321 RAYBURN HOUSE OFFICE BUILDING
WASHINGTON, D.C. 20515

JOHN L. SWIGERT, JR.
EXECUTIVE DIRECTOR

HAROLD A. GOULD
PHILIP B. YEAGER
FRANK R. HAMMILL, JR.
JAMES E. WILSON
J. THOMAS RATCHFORD
JOHN D. HOLMFELD
RALPH N. READ
ROBERT C. KETCHAM
ROBERT B. DILLAWAY
REGINA A. DAVIS

MINORITY COUNSEL:
MICHAEL A. SUPERATA

July 22, 1976

Mr. Joe Newman
1521 Derwood Drive E
Mobile, Ala. 36618

Dear Mr. Newman:

In a recent telephone conversation, Capt. Ronald Evans informed me that you have, in work, a new energy concept that might be useful in this Country's present problem, and wished to know a forum where this concept might be introduced.

The Department of Commerce has just such a forum for new inventors, the Office of Energy Related Inventions.

It is my recommendation that you describe your invention in a letter to:

Mr. George P. Lewett
Chief, Office of Energy Related Inventions
National Bureau of Standards
U.S. Department of Commerce
Washington, D.C. 20234

This office will assist you in evaluating your ideas.

Sincerely,

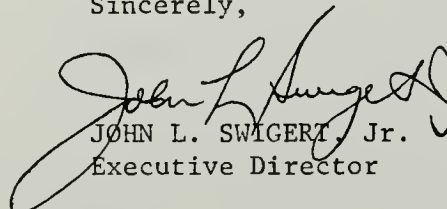
JOHN L. SWIGERT, Jr.
Executive Director

December 20, 1975

1521 Deerwood Drive, East
Mobile, Alabama 36618
Phone: 205 - 344-9767

Mr. George P. Lewett
Chief, Office of Energy-Related Inventions
UNITED STATES DEPARTMENT OF COMMERCE
National Bureau of Standards
Washington, D. C. 20234

Dear Mr. Lewett:

Today I received your letter of December 16, 1975.

While your comments are disappointing, they are not surprising to me at all. They conform exactly with the attitude of the correspondence that I have previously received from the National Science Foundation, Atomic Energy Commission, National Aeronautics and Space Administration, as well as others.

Truth is of great importance to me as a man and a scientist. The results of my scientific efforts for the last 10 years are as follows:

1. Reputable Scientific Journals only print the hypothesis of elite scientifically recognized physicists and etc.
2. Of all the correspondence I have received from your department, as well as those scientific departments listed above, none have the ability to give exacting scientific argument against the scientific findings I have put forth in my document.
3. How can this be? The scientific statements made in my document are made in a most definite scientific manner, there is no scientific rhetoric or ambiguous statements and, therefore, should be easy to disprove if they are wrong.
4. On the other hand, reputable scientific individuals I have spent time with recognize that I may have a most unusual scientific ability.

This is evident by the letter from Dr. Edward Leverne Moragne, of which you have a copy.

It is also evident by the comments made by Mr. David J. Eden, (Director of Department of Commerce), to my patent attorney firm, (Schuyler, Birch, Swindler, McKie and Beckett), after meeting and talking with me in Washington, D. C. and then reading my scientific document.

Mr. Lewett
Page two
December 20, 1975

It is also evident by the comments made by Robert W. Gundlach, Top research scientist with Xerox Corporation, with whom I spent the night in his home and discussed my scientific efforts. Quote: "He had no doubt that the mathematical evidence that I had put forth concerning the tilts and orbits of the planets was correct. That he very often used the mathematics of probability in his line of research and that the mathematical evidence I had put forth fit those laws exactly." Unquote:

Conclusion: There is certainly something gravely wrong with the present scientific communication system for me to have encountered these results.

I was told that your department was set up to alleviate this type of inefficiency in the gaining of scientific knowledge.

Quote from letter of Mr. Atwell, (Deputy Chief of Operations, Office of Congressional Affairs), dated September 9, 1975: "The Federal Nonnuclear Energy Research and Development Act of 1974 assigns responsibility for evaluating and funding all promising energy-related inventions (particular those submitted by individual inventors and small companies) to the National Bureau of Standards (NBS) for analysis and possible grants." Unquote:

On studying the results of my ten years of scientific efforts, is it not wiser for your department to use its influence and request a reputable scientific journal or journals to print my scientific findings for the purpose of having them proven or disproven and then have those results forwarded back to your office, whereby, a sound scientific conclusion could then be drawn?

I am certain my scientific findings will contribute to the well being of all people on earth and will enable mankind to efficiently advance to other solar systems.

I await your earliest reply.

Sincerely,

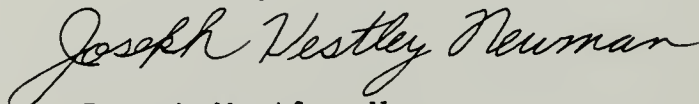

Joseph Westley Newman

JWN/en



UNITED STATES DEPARTMENT OF COMMERCE
National Bureau of Standards
Washington, D.C. 20234

January 28, 1976

Mr. Joseph W. Newman
1521 Deerwood Drive, East
Mobile, Alabama 36618

Dear Mr. Newman:

We wish to acknowledge your letter of December 20, 1975, requesting this office to submit your scientific findings to a reputable scientific journal for publication.

It is unfortunate that you have had difficulty in getting your material published in a scientific journal. However, this office cannot comply with your request to use its influence to get your ideas published. We are not in a position to endorse or repute your findings, since, as stated in our previous letter, it is not our function to make judgments about new theoretical propositions which challenge accepted theory.

Since you have had considerable dialogue about your findings with the several scientists you mention in your letters, perhaps they could assist you in this matter.

Sincerely,

George P. Lewett
Chief, Office of Energy-Related Inventions

RICE UNIVERSITY

HOUSTON, TEXAS

77001

DEPARTMENT OF SPACE PHYSICS
AND ASTRONOMY

September 7, 1976

Mr. Joseph W. Newman
1521 Deerwood Drive, East
Mobile, Alabama 36618

Dear Mr. Newman:

I have looked over your latest manuscript on the relationship of magnetism to various physical features in the universe. As with your previous work, I found it imaginative and filled with original ideas. The work shows you have both a strong interest in physics and a definite native ability. However, I am afraid that I cannot encourage you with regard to the possible publication of your work in any standard scientific journal. Let me illustrate with one specific example.

On page 14 you mention an experiment with a pendulum and your ninety pound magnet. Using standard electromagnetic theory (Maxwell's equations), I believe the change in period for a swinging pendulum can be calculated for the cases where the magnet is brought near the pendulum. The presently accepted theory would predict that a decrease in the pendulum period will occur only when the pendulum material is a conducting material. That is, the magnet would have no effect if the pendulum bob were composed of a nonconducting material such as glass or teflon. If your results are different from this, Maxwell's theory would be upset, and you would have a firm building block to advance your theory. However, you simply state your results with no data and, therefore, no chance for anyone to check your result against standard electromagnetic theory. It is for reasons such as this that your manuscript would, in my opinion, not be understood by the audience you are trying to address.

To write up your pendulum experiment properly for

2-Mr. Joseph Newman

9/7/76

scientific journal publication would require an understanding of Maxwell's equations in vector form. If you can show, while speaking the language of the audience with whom you are trying to communicate, that Maxwell's equations are invalid, you would have a chance to push forward your new theory. However, I do not believe you will have an opportunity to do so unless you can communicate with the physicists and astronomers of the world in their own language.

Once again, I would urge that you consider obtaining a formal education in physics so that you can present your results in accepted mathematical form and scientific notation. The rules of the game are fair, and they are clearly defined. If you want to play, you must follow the rules. Alternately, your work has no doubt been of great personal satisfaction, and you might consider being satisfied with that and give up the idea of communicating with physicists (who will insist you speak their language).

Should you decide to obtain a formal education in physics, please do not hesitate to contact me regarding advice on this move.

Good luck in your endeavors.

Yours truly,



A. J. Dessler



Department of Energy
Washington, D.C. 20585

Mr. Joseph Westley Newman
1521 Deerwood Drive, East
Mobile, Alabama 36618

Dear Mr. Newman:

Your letter to President Carter was referred to the Department of Energy for reply.

There are two issues which you have presented in the letter. The first is that you would like someone to debate, agree or disagree with your paper setting forth your ideas, hypotheses and conclusions about electromagnetic energy, and second you would like to receive a Federal grant with which to continue work on your ideas.

I will reply first on the matter of grants. As you might imagine, the procedure for getting Federal funds is closely prescribed. I am enclosing the "Guidelines for the Submission of Unsolicited Proposals," which tells you how to apply. Essentially you have to tell what you want to do and how you plan to do it. The Department's program managers must see clearly that supporting your project plan would support their mission and plan. Consequently, you will not be able to ask for support on something which you can't reveal.

I have read the document that you sent and I will be happy to comment on a few examples that come early in your paper to point out other ways to look at them.

It does not follow, without question, that the man holding up the 400 pound weight proved that the work equals force times distance moved - formula is invalid. One could say that it was inappropriate to use the formula for more than a first order description. All such laws are used with much qualification and reservation.

In your case of radiation appearing with the burning of the log... thereby proving disappearance of gravity...another way to look at that case is -- the "aggregate" material is gone and so is the "aggregate" gravitational effect...there is nothing to suggest that the mass-energy residues are not affected by gravity. It is crucial to look at cases such as the above because they are premises for your conclusions.

...Could a Faraday experiment be carried out under conditions of weightlessness? (p. 9) ...Your connection between "weight" and "electromagnetism" is couched in a statement which ignores the "mass" deposited...

Certainly a few comments cannot cover the very extensive work that you have done. I do hope that they raise classes of questions which you may consider.

Sincerely,

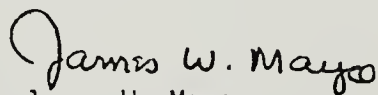

James W. Mayo
Scientific Advisor
Office of the Assistant Secretary
for Energy Technology

Enclosure

August 27, 1979

Mr. Joseph Newman
1521 Deerwood Drive, East
Mobile, Alabama 36618

Dear Joe,

I am getting almost as frustrated as you. I have not been able to arrange any sort of demonstration meeting with people that would know what you are talking about. Some of them are still on vacation; however, with others the problem is more serious. Most of them are not interested. They say that Maxwell's equations and theories are the best understood of all the laws of physics and that any attempt to show that they are wrong or that he arrived at the wrong conclusions is useless.

Sorry to be the bearer of such bad news but that's the way it stands now. I'll keep trying to set up a demonstration and also try to get a competent review of your document but right now the prospects are not too encouraging. I'll keep in touch with Lynn Pitchford and keep him informed. In the meantime keep up the experiments and try to write some of them up very simply so that they can be published in a technical journal.

Good luck,



Robert E. Smith
125 Westbury Drive, SE
Huntsville, Alabama 35802



STATE OF ALABAMA

GOVERNOR'S OFFICE

MONTGOMERY 36130

March 12, 1979

FOB JAMES
GOVERNOR

Mr. Joe Newman
1521 Deerwood Drive, East
Mobile, Alabama 36618

Dear Joe:

I appreciate your letter of February 4, and allow me this opportunity to express my gratitude for your support during the campaign. I will do my best to do a job that will make you proud. Have been tied down about 16 hours a day since taking office but hope things will ease up a little next week and give me time to act on your letter.

I remember very well our conversation and experiences regarding the scientific community and will act accordingly. Joe, if energy could be released from electromagnetic fields of force, it would be a godsend to this country.

Hope to see you soon.

Sincerely,

FJ:ew

Who's Who in Technology Today

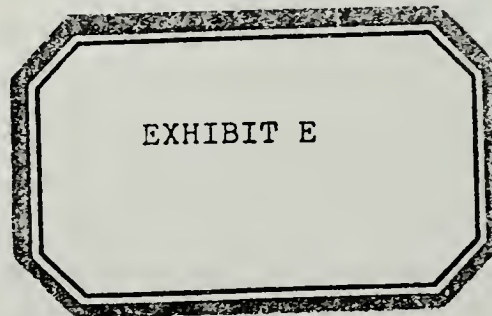

PHYSICS AND RELATED TECHNOLOGIES

Nelson, Donald F.
Member of Technical Staff

Presently associated with: Bell Telephone Laboratories, 600 Mountain Avenue, Murray Hill, NJ. 07974. Started in 1968 and is now serving in above capacity. Received the Doctorate Degree (Technical) in 1958 from the University of Michigan. Accumulated 21 years of professional experience. Holds 6 U.S. Patents. Author of 1 technical book and 80 articles. Also active in the field of Optics. Principal expertise involves:
Crystal Physics, Lasers, Ultrasonics

Nesterczuk, George
Consulting Scientist

Presently associated with: EG & G/WASCI, 6801 Kenilworth Avenue, Riverdale, MD. 20840. Started in 1977 and is now serving in above capacity. Received a Masters Degree (Technical) in 1971 from the University of Maryland. Accumulated 8 years of professional, and 6 years of managerial experience. Author of 20 technical articles. Served as Corporate Director and Officer. Technical involvement includes experience in Oceanography. Principal expertise involves:
Remote Sensing and Satellite Systems

Newell, Philip B.
Senior Engineering Specialist

Presently associated with: GTE Sylvania, 100 Endicott Street, Danvers, MA. 01923. Started in 1976 and is now serving in above capacity. Received the Doctorate Degree (Technical) in 1969 from Boston University. Accumulated 19 years of professional, and 5 years of managerial experience. Holds 1 U.S. Patent. Author of 6 technical articles. Also active in the field of Optics. Principal expertise involves:
Applications and Design Xe Flashlamps

Newman, Joseph W.
Scientist; Inventor

Self-Employed as Scientist; Inventor since 1961. Accumulated 18 years of professional experience. Holds 7 U.S. Patents, and has experience in the evaluation of Patent Office actions. Author of 4

Archivist &

technical articles. Also active in the field of Advanced Technology. Principal expertise involves:
Unified Theory of All Physical Phenomena

Nisenoff, Martin
Research Physicist

Presently associated with: Naval Research Laboratory, 4555 Overlook Road South West, Washington, DC. 20375. Started in 1972 and is now serving in above capacity. Received the Doctorate Degree (Technical) in 1960 from Purdue University. Accumulated 19 years of professional, and 8 years of managerial experience. Has acted as a consultant relating to Patent disclosures. Author of 50 technical articles. Technical involvement includes experience in Electronics. Principal expertise involves:
Superconductive Electronics

Nygaard, Kaare J.
Professor

Presently associated with: University of Missouri at Rolla, Rolla, MO. 65401. Started in 1968 and is now serving in above capacity. Received the Doctorate Degree (Technical) in 1964 from the Norwegian Institute of Technology (Norway). Accumulated 15 years of professional, and 8 years of managerial experience. Author of 99 technical articles. Technical involvement includes experience in Electronics. Principal expertise involves:
Ionization Laser Kinetics Education

NG, Yee S.
Research Assistant

Presently associated with: Pennsylvania State University, Physics Department, 104 Davey Laboratory, University Park, PA. 16802. Started in 1976 and is now serving in above capacity. Received a Masters Degree (Technical) in 1977 from Pennsylvania State University. Accumulated 5 years of professional experience. Author of 7 technical articles. Also active in the field of Metallurgy. Principal expertise involves:
Atom-Probe FIM, Surface Segregation

AFFIDAVIT

September 17, 1984

TO WHOM IT MAY CONCERN:

I would like to present a few observations and comments regarding Joe Newman's theory of operation of his motor. His theory is a unified field theory based upon Einstein's equivalence of matter and energy. According to Einstein's famous equation, $E=mc^2$, every conversion of energy involves a corresponding mass loss. (E in this equation represents total energy of a system, kinetic and potential, and m is the system mass.) Thus, for example, when two atoms combine and give off light, the atoms weigh less after combining than before, and the difference is accounted for in the light energy. Newman's interpretation of these notions states that all matter and energy consists of elementary spinning particles. This reduces Einsteins relation to a process of counting elementary particles. In the above example both the atoms and the light consist of the elementary "gyroscopic" particles. Some particles are released in the form of light when the atoms combine. According to Einstein's theory, and Newman's interpretation, energy generation in the Newman motor must necessarily involve a conversion of matter to energy. This statement is equally true for any system which generates energy. This statement is also perfectly consistent with the first law of thermodynamics, and does not violate the second law.

The nature of the spin of the gyroscopic particles in Newman's theory provides a qualitative understanding of electromagnetic phenomena. In fact, Newman conceived the theory originally to explain electromagnetic effects. Thus, electric and magnetic fields, including static fields, consist of gyroscopic particles moving at the speed of light. Creation of a field requires a corresponding mass loss, or loss of gyroscopic particles, from a system. Newman's motor concept provides a means for trapping gyroscopic particles in a long coil of wire, which catalyzes the release of particles from the wire in the form of very large magnetic fields. It must be considered significant that Newman conceived of the theory of operation of his motor before he constructed the first working prototype. It may be expected that the motor operation can be explained in terms of the mathematical theories of electromagnetism and relativity, however we cannot expect or require Mr. Newman to perform such a feat.

09/18/84

Lana D. Peters

 LANA D. PETERS
 NOTARY PUBLIC - MINNESOTA
 DEWEEA COUNTY
 My Commission Expires Mar. 19, 1988

Roger Hastings

 Dr. Roger Hastings, Ph.D.

ARNOLD R. SMYTHE, JR.

CONSULTING STRUCTURAL ENGINEERS, INC.
234 GLENDALE DRIVE - METAIRIE, LOUISIANA 70001 - (504) 831-7504

October 19, 1984

TO WHOM IT MAY CONCERN:

Mr. Joseph Newman, of Lucedale, Mississippi, is attempting to achieve issuance of patents on an energy producing device developed by him, and on the underlying scientific principles discovered by him.

The comments offered here are in response to the "Report of the Special Master", Civil Action 83-0001, dated September 28, 1984.

The statements of the Special Master indicate that he believes there is adequate evidence of the validity of Mr. Newman's device and that it performs as Mr. Newman claims. The Special Master, however, rejects Mr. Newman's explanation of the unique physical phenomena which cause the device to function. I consider this apparent rejection to be contradictory and intellectually inconsistent. Please note that Mr. Newman divulged his theories of conversion of mass into energy prior to the construction of his first prototype device. The successful operation of this first prototype confirmed the rightness of his theories.

In my opinion, the correct application of the Scientific Method must conclude that there is adequate evidence to allow the issuance of a Pioneering Patent to Mr. Newman. My opinion is based on my observations of the prototype device and the underlying theory as propounded by Mr. Newman. These observations were made during two presentations by Mr. Newman before groups of engineers, and during two private all-day sessions with Mr. Newman at Lucedale.

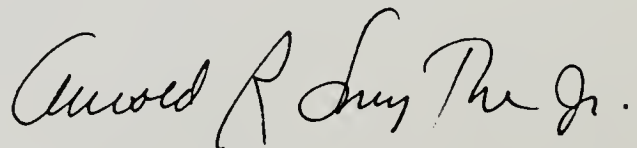

Arnold R. Smythe, Jr.

Consulting Structural
Engineer

STATE OF LOUISIANA
PARISH OF JEFFERSON

SWORN TO AND SUBSCRIBED BEFORE ME THIS 20th DAY OF OCTOBER, 1984.

MY COMMISSION EXPIRES
AT DEATH

230
THE ENERGY MACHINE OF JOSEPH NEWMAN

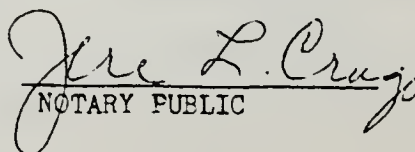

NOTARY PUBLIC

Evan R. Soule, Jr.
1135 Jackson Avenue, Apt. 305
New Orleans, Louisiana 70130
(504) 524-3063, 866-7656

STATE OF LOUISIANA
PARISH OF ORLEANS

AFFIDAVIT

RE: Report of the Special Master dated September 28, 1984 for Civil Action 83-0001

The following two statements from the Report of the Special Master totally contradict one another:

from Point #9: "Evidence...is overwhelming that Newman has built and tested a prototype of his invention in which the output energy exceeds the external input energy."

from Point #10: "There is no evidence corroborating Newman's scientific theory..."

As a scientist familiar with Joseph Newman's work, I must ask this question:

"Who is better qualified to determine the rightness of his scientific theory than the inventor of the energy machine for which the evidence is overwhelming (in the words of the Special Master) that the machine works?"

It is also important to note that Joseph Newman built this workable prototype based upon and several years after he submitted to the Patent Office his scientific theory which made it possible for him to know how to build such an invention in the first place.

The energy machine prototype is overwhelming evidence that totally corroborates Joseph Newman's scientific theory.

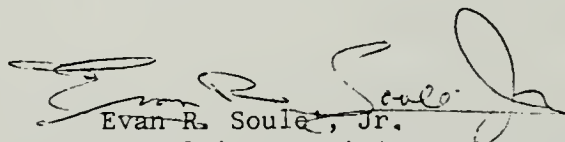
Evan R. Soule, Jr.
Consulting physicist

SWORN to and SUBSCRIBED before me this 19
day of OCTOBER 1984
at New Orleans, Louisiana.

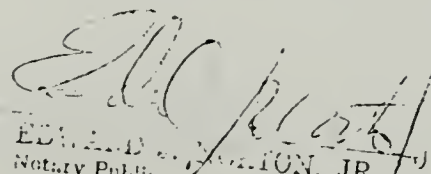
EDWARD J. NORTON, JR.
Notary Public
EDWARD J. NORTON, JR.
NOTARY PUBLIC, PARISH OF ORLEANS, STATE OF LOUISIANA
MY COMMISSION IS ISSUED FOR TWO

JOHN P. GILLIS, D.D.S.
5037 Veterans Memorial Blvd.
Dental-Medical Plaza
Metairie, Louisiana 70003
October 21, 1984

STATE OF LOUISIANA

JEFFERSON PARISH

AFFIDAVIT

Ref: Report of the Special Master dated September 28, 1984
for Civil Action 83-0001.

With all due respect for the conclusions of the report by the Special Master, it is quite clear that there is a contradiction in the implied argument that Newman's prototype is not corroboration of his scientific theory.

As is well known, in this area of research, the existence of subatomic phenomena such as Newman's hypothesized gyroscopic particles is theoretical and not directly observable. The standard corroborative mechanism for research in this domain involves predicting energy transformations that can be observed as a result of manipulation of the hypothesized subatomic phenomena.

Newman has clearly met these criteria for corroboration of his scientific theory. Newman hypothesized the existence of gyroscopic subatomic phenomena initially, and then followed the standard corroborative procedure by predicting energy transformations that could be observed experimentally. Newman then designed and built an experimental device, the prototype of his invention, which enabled him to observe the predicted energy transformations of the gyroscopic phenomena described in his scientific theory.

The Special Master explicitly states that Newman's invention functions as claimed and can be duplicated by others. However, the Master concludes that this device is in no way supportive evidence for corroboration of Newman's scientific theory of subatomic gyroscopic phenomena. This conclusion is clearly in contradiction with standard scientific procedure. It appears that the obvious has been overlooked, which is, that without Newman's initial scientific theory the probability of his building a workable prototype of this nature is infinitesimally small.

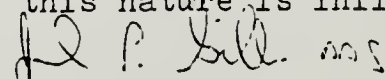
John P. Gillis D.D.S.

Sworn to and subscribed before me
this 22 day of October, 1984

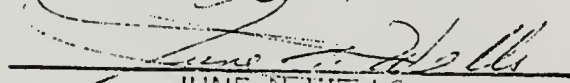
JUNE N. WELLS

Notary Public

My commission is for life

J. Richard Trinko, Jr.
Consulting Engineer

STATE OF LOUISIANA

ORLEANS PARISH

AFFIDAVIT

RE: Report of the Special Master dated September 28, 1984 for Civil
Action
83-0001

It is my understanding that Mr. Joseph Newman is being denied a patent on the concept of his invention for the following reason:

"There is no evidence corroborating Newman's scientific theory involving gyroscopic type energy particles to explain how mass to energy conversion is accomplished by his system; claims which specifically recite that theory were properly rejected." RE: Item No. 11.

I would like to suggest to the Special Master that very few, if any, new inventions or scientific theories are perfected at the time of patent application. Perfection generally follows development of applications. Imperfections, if they exist in the Newman patent application, should not invalidate Mr. Newman's rightful claim to the basic concepts of his invention. Indeed, justice demands that he be granted a patent on the basic concepts because:

"Evidence before the Patent and Trademark Office and this Court is overwhelming that Newman has built and tested a prototype of his invention in which the energy output exceeds the external input energy; there is no contradictory factual evidence." RE: Item No. 9.

I submit that since the prototype demonstrably produces more energy output than energy input, he should be granted a patent on the concepts as claimed without regard to imperfections in theory, as postulated by the Special Master. To the extent that his original claims prove correct, he is entitled to patent protection. To the extent that future studies prove that they are false, neither he nor others will be penalized. Justice is best served, therefore, by granting him a patent on his original concepts as claimed. A gross and grievous injustice is assured by denying him patent protection on concepts which prove to be correct.

Sincerely,

Joseph Richard Trinko, Jr. Ph.D.

Joseph Richard Trinko, Jr., Ph.D.
185 Walnut St., Unit 3
New Orleans, LA 70118

Sworn to and subscribed before me this date.

Marian H. Aubrey - Oct 22, 1984

Notary Public

STATE OF LOUISIANA

ORLEANS PARISH

AFFIDAVIT

RE: Report of the Special Master dated September 28, 1984 for Civil Action 83-0001

Mr. Newman developed his scientific theory involving gyroscopic type energy particles some ten to fifteen years prior to his building of an apparatus. His discovery in theory, indeed, predicted that such an apparatus could be built. He then built the apparatus. Mr. William E. Schuvler Jr., Special Master, has stated that the evidence is overwhelming that Newman has built and tested a prototype of his invention in which the output energy exceeds the external input energy. In other words Mr. Schuvler states that Mr. Newman's apparatus corroborates his theory. But, then Mr. Schuvler goes on to state that there is no evidence corroborating Newman's theory. It is a total contradiction to say in one breath that the theory is overwhelmingly corroborated and in another that there is no evidence of corroboration. This implies to me that Mr. Schuvler has not mastered Newman's theory.



Eric J. Szuter
Vice President/General Manager
Haller's Air Conditioning Maintenance
and Engineering Service

Sworn to and Subscribed before me
this 22 day of October, 1984.

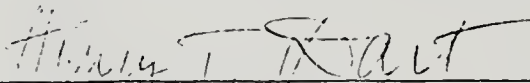

Notary Public

STATE OF LOUISIANA

ORLEANS PARISH

AFFIDAVIT

RE: Report of the Special Master dated September 28, 1984
for Civil Action 83-0001

For the past year I have spent many hours studying Mr. Newman's motor and studying his theory. I am firmly convinced that his theory is the more significant of the two inventions and that the motor was developed from the theory. Thus, if the motor is deemed to have value (Statements #8 and #9 of Special Master), the theory must therefore be of greater value than the motor.

I agree with Statement #9 that a skilled person could build a Newman motor from the description in the patent, however, I doubt that a normally skilled person could read Mr. Newman's theory once or twice and learn to build such a device. This may be possible for certain highly skilled persons, however, and thereupon lies the rationale for granting Mr. Newman's theory pioneering invention status. For without such protection, the theory of Mr. Newman's may never be available to the public for lack of protection for its disclosure. This theory, so contrary to the established laws of electromagnetics that I was taught during my undergraduate curricula in physics, will require deep and prolonged study by scientists who are willing to consider the possibilities of a completely new scientific paradigm. The process of forming a new scientific paradigm is fraught with problems as described in Thomas Kuhn's "The Structure of Scientific Revolutions" published by The University of Chicago Press in 1962. On page 151

Kuhn quotes Max Planck: "a new scientific truth does not triumph by convincing its opponents and making them see the light, but rather because its opponents eventually die, and a new generation grows up that is familiar with it."

A scientific theory is a simplified model of how the universe works. Models can be used to explain why certain known phenomena occur and to explain how to produce hitherto unknown phenomena. Mr. Newman's theory qualifies on both counts:

- 1) The theory explains why electric and magnetic fields are perpendicular to each other. Everybody knows this is so and uses this knowledge, but no one has ever produced a model to explain why up until now. Mr. Newman's theory of gyroscopic particles explains why. In essence these particles, spinning like miniature gyroscopes, produce perpendicular forces when deflected exactly as gyroscopes do. Mr. Newman has created a theory that predicts an underlying unity of spinning masses and electromagnetic fields.
- 2) The theory explains how to produce more energy from a device than is put into it (obviously a hitherto unknown phenomena). The prototype demonstrates this to be a fact on the basis of overwhelming evidence (Statement #9).

Isaac Newton's theory in the 17th Century made it possible to predict exactly the orbits of planetary bodies, but it wasn't until Halley's Comet arrived right on the date predicted that Newton's work was corroborated.

Albert Einstein's theory required an experiment be

performed during a total eclipse in order to corroborate it. This seemingly innocuous experiment confirmed a theory which has made nuclear power a reality in our time.

Joseph W. Newman's theory has enabled Mr. Newman, who understands it best at this time, to manufacture a machine that taps energy from the sub-atomic structure of matter in a controlled manner. This can be considered as nuclear power without the destructive side effects of bombs and radioactivity.

Statement #8 says "Operation of Plaintiff's System seems to clearly conflict with recognized scientific principles relating to thermodynamics and conservation of energy." In the presence of a conflict, a true scientist will either disregard the conflict as a spurious anomaly (as the Patent Office has done with Mr. Newman's theory for many years) or the scientist will produce a new theory which will explain all currently understood phenomena plus the anomalous phenomena. This is precisely what Mr. Newman's theory does. Mr. Newman's theory may lack the precision of exposition of an academically trained scientist, but what trained scientist would ever spend time investigating a process he had been taught was clearly impossible? Undoubtedly trained scientists will welcome the opportunity to add mathematic precision to Mr. Newman's theory and the decision to give them access to this material must include full protection under law for Mr. Newman's innovative concepts as embodied in his pioneering inventions.

RJ M
ROBERT JOSEPH MATHERNE
OCTOBER 21, 1984

10/22/84

*document was submitted
before me on 10/22/84
by J. Matherne
J. T. West
Nuclear Power*

Chapter 21

THE PROPER TEACHING SYSTEM

"Bacon in his instruction tells us that the scientific student ought not to be as the ant, who gathers merely, nor as the spider who spins from her bowels, but rather as the bee who both gathers and produces."

— Michael Faraday

The facts of history clearly illustrate the injustice of the present teaching system. One has only to observe each separate aspect of science — physics, astronomy, chemistry, medicine, etc. — to see that the common denominator is the fact that, during their instant of time in history, those creative individuals who made the greatest positive contributions were generally persecuted or ridiculed by their colleagues. Many such contributors were never recognized during their lifetimes for their achievements. As a matter of fact, such recognition (when given at all) was generally not forthcoming until a century or more after their deaths.

QUESTION: Why should the greatest contributors in history be so treated?

With small children, one can observe that they are excited, stimulated and mystified by observing and experiencing new information. The child does not become angry or intimidated by new information or discovery.

The history of science clearly demonstrates that the so-called "conventional scientists" of a given age were intimidated, angered, or even felt threatened by new and beneficial scientific contributions from contemporary creative individuals.

Over the years, I have personally seen and experienced this same response from many conventionally-educated and scientifically trained individuals concerning my work. I have often stated that the problem I was having with these individuals was a "psychological problem" and not a "true scientific problem"!

Because I am a human being, I have at times become angry with such individuals when I observed that they did not wish to think, question, or search for "Absolute Truth." Since I am a fair person, however, I can honestly state to myself, "I know their negative actions are not their fault." Such individuals are only acting as the present teaching system has taught them to respond since they entered the first grade.

Therefore, I conclude that these individuals have been "*unjustly influenced*" by an incorrect teaching system that has existed for centuries.

In clinical psychiatry, such a negative response would be called "The Denial Syndrome." This means that, if a person mentally feels threatened by information presented to her/him, then that individual may respond by denying the information.

EXAMINE THE FOLLOWING FACTS:

From adolescence to maturity, an individual is instructed to memorize, mimic, and not question or challenge what is taught. Then the individual is informed that some of what he/she has learned is wrong and must now question it. Because that individual has been "unjustly taught," one can easily understand why that individual would feel threatened by such an approach and would psychologically respond by "denying" what is proposed. *How sad is this fact for humanity.*

At four years of age, such an individual would not have responded so negatively and thus denied herself/himself the excitement of understanding new discovery which stimulates and invigorates the questioning mind.

The following fact should cause the reader to think: One can acquire numerous Ph.D.'s during one's lifetime, but in so doing one has only learned to mimic various "crafts." *One is only a scientist when one questions and challenges what is being taught.* A four-year-old human being has scientific instincts, but ironically most Ph.D. individuals who have been "unjustly influenced" by the present teaching system do not. *A scientist is simply an individual who seeks "Absolute Truth" above all else!*

The following is a very important QUESTION:

How is it possible for me, living in the backwoods of Mississippi with limited money and limited conventional training/education, to have achieved the innovation of a totally new energy source, plus much more?

Also, consider the fact that the conventionally-taught, scientific community has had over 30 years, thousands of conventionally-trained "scientists," and billions of dollars to create a more efficient means of mechanically converting mass into energy in accordance with Einstein's Equation of $E = MC^2$ (rather than the inefficient conventional, nuclear-reactor, mechanical method which was initially prompted by an accidental discovery of the fission of heavy nuclei by two chemists in Germany — Otto Hahn and Lise Meitner).

Despite the above facts, such conventionally-trained scientists have failed to achieve any practical or significant improvement in energy conversion and production efficiency. In lieu of such failure, why have I succeeded?

ANSWER: The conventionally-trained scientists have been

“unjustly taught” by the conventional teaching system that they did not have to **mechanically** understand Gravity, Magnetism, Electricity, Inertia, Planetary Motion, Light, Heat, etc., and that it was sufficient to simply provide mathematical formulae for such effects.

When I read such teachings, I was totally shocked! My natural questioning instincts of “How, Why, and What” told me that it was not only necessary but *imperative* to understand the mechanical essence of these effects.

This simple distinction in mental attitude between the conventionally-trained scientists and myself provides the reason for the significant difference in results.

It is also interesting to note that the very essence of the present teaching system so conforms the students’ minds that they were not and are not shocked as I am by the conventional-teaching statement described above.

I do not write these observations to offend the reader; quite the contrary: I write them because I care very deeply about the future of humanity.

I repeat: It is my deep, caring belief that in future years, our descendants will view these times as the true “Dark Ages,” whereby they will state:

“My parents and ancestors were taught in such a manner that the natural curiosity with which they were born was significantly stifled; whereas we are taught in such a manner that our natural curiosity birthright is stimulated and not stifled.”

In effect, I believe that future generations will actually feel sorry for their ancestors. If you have grown children, perhaps you can recall the excitement of mental anticipation that was mirrored in their eyes when they were five years old or less and their birthright curiosity was “as free as the wind.” If you now examine the mature eyes of your children, you will not find the spark of mental excitement, anticipation, and the free birthright of curiosity. What a terrible and ironic misfortune that such a loss of curiosity was bequeathed to them with the best of intentions.

Let me give you another example of this loss:

Imagine if you will, a highly creative individual from another Solar system visiting the planet Earth and conducting the following simple experiment:

The interstellar visitor initially conducts the experiment on an Earthling who is four years of age. The “test experiment” is measured and graded on a scale of 0 to 100 with respect to the innate curiosity of the young Earthling. From one’s observational experience with young children, it is very likely that the young Earthling would achieve a “curiosity score” of perhaps 80 to 90 out of 100. After scoring, the visitor unobtrusively tags the young Earthling for future identification and then proceeds to leave the Earth. Twenty years later, the interstellar visitor returns. The tagged Earthling is now twenty-four years old and the same “curiosity test” is again conducted by the visitor on the same Earthling. In analyzing the new results, the interstellar visitor would be shocked. With a maximum “curiosity score” of 5 to

10 out of 100, the visitor would discover that the Earthling is virtually devoid of curiosity.

The visitor would then wonder: “What tragedy could possibly have happened to the Earthling during the twenty-year period?” Were the visitor to be informed of the nature of the Earth’s present teaching system, the visitor would understand the full extent of the tragedy that the tested Earthling had endured during the past twenty years.

I am certain that the reader is aware that all young children possess immense curiosity. However, because children are so perceptive, they learn quickly and tend to strive for the approval of their peers and especially their loved ones. As a result of good intentions, it is ironic that these children are pressured to forsake their natural birthright of curiosity and only strive to “make the grade,” *i.e.*, to obtain the family/teacher-inspired “A.”

Being perceptive, children quickly learn that the *name of the game is memorization*. Like a parrot, the more precisely the child can quote or mimic what is “taught,” the better the grade obtained and the greater the approval from teachers, peers, and especially loved ones. The impressionable child clearly learns *not* to question or honestly challenge what the teachers present in class, since this results in only reprisal from her/his peers and sometimes even from her/his teachers.

As a result of this non-educational process, the child strives only to “make the A,” forsakes the natural birthright of curiosity, fails to truthfully question what is taught, and, with time, subtly loses a beautiful, glimmering light from her/his eyes.

I sincerely and caringly ask that all individuals on this planet teach their children by the following method:

- (1) Encourage your children not to memorize data but rather to *learn the essence* of many different subjects. Moreover, *the more they learn, the more they can question!*
- (1) It is most important for the parent to encourage and highly commend the honest questioning of such varied subjects. One should not question for the purpose of disruption, but rather question with the honesty and integrity of one’s natural birthright. *Children should diligently seek to answer their own honest questions if a satisfactory answer is not provided by others.*
- (3) Instruct your children to honestly question throughout their lives, since only then are they truly free human beings. With this healthy attitude throughout their lives, such children will find truth as well as maintain the excitement and light in their eyes to reflect their intelligent, questioning mind.
- (4) Teach your children to strive to understand the essence of all that they experience. Teach them to

be "humble" and sensitive to the fact that the more they learn, the more they become aware of how much there is to know. Therefore, teach them to continuously learn and question.

I am certain of the following: If all children were taught as I have described, then dictators and crooked politicians could not exist and continue to perpetrate themselves.

Questioning individuals would maintain an account of the promises of politicians and also have the means to maintain a permanent record of elected politicians' performances. If they discovered that the politician lied to them, such questioning individuals would quickly initiate a petition of such magnitude that they would recall and evict the lying politician from office. The same pro-

"Subconsciously, you already know that these material items are replaceable, but the memories you cherish are not replaceable."

cedure would apply to inept elected judges. Where the judges are appointed, then the politicians who appointed them would be held accountable.

Honest and questioning individuals will question all subjects and problems they encounter; more importantly, they will earnestly seek to efficiently solve such problems. As a result, such educated inhabitants of a planet would have very few difficulties since encountered problems would be quickly solved.

In essence, it is my purpose to teach all inhabitants of this Earth to "THINK." The balance of this Book will so verify this fact.

It is imperative that the present teaching system change to a format consisting of honest, questioning individuals devoted to discovering "Truth" above all else. World Peace can result from the efforts of the planetary inhabitants so taught.

Continue to read this Book and please open your mind for the purpose of seeking the "Absolute Truth." Please do not blindly accept what I teach, but, on the contrary — question what I teach and question what you have been taught by others. I specifically ask that you do the following: *Truthfully question everything, discarding that which is "false" while adhering to and teaching your children what is "true."*

The Formula for Happiness

Despite the best of intentions, it is ironic that adults and the teaching system instill in children the view that the pursuit and acquisition of material wealth (money or its equivalent) will bring forth happiness to them and their family.

Such a teaching is totally false! I urge you to prove this falsehood to yourself. Consider for a pleasurable

moment the events that have occurred in your life and search your mind for those events that generate a warm and tender feeling within yourself.

I can predict the nature of your memories. They will consist of thoughts concerning your mother, father, brothers, sisters, grandmother, grandfather, other relatives, friends, or even an animal — thoughts involving your efforts to contribute to the well-being of another, and their efforts to contribute to your well-being. Although you may not have reflected on these meaningful memories for years, you nevertheless experience the inner warmth of those memories and even now tears may come to your eyes.

Please observe that it is *not* the memory of material objects that you recall — you are not remembering the first bicycle, skates, automobile, house, boat, or plane that you received. Subconsciously, you already know that these material items are replaceable, but the memories you cherish are not replaceable.

What is the "Truth" of which I speak?

As you will find, my interests go far beyond the energy machine I have innovated. I wish to strive for the improvement of all humanity in a very fundamental manner.

The following is a song I wrote several years ago concerning this "Truth": [Even if you do not appreciate this song, or find it "trite," please sing this song to your children. They will appreciate it.]

SUBCONSCIOUS MIND

*Oh, Subconscious mind, tell me the truth
Where does it lie, the truth of life that I seek*

*Even as a child receiving toys
And as an adult receiving ever more expensive toys
I have anticipated them all with great joy
But perpetually, once received, the joy has always
disappeared from me*

*Oh, subconscious mind, where do the memories lie,
so dear to me*

*Always it has been a close and personal tie
Relative, friend or other, where we have always been
of benefit
to one another*

*Oh, subconscious mind, tell me the truth
Where does it lie, the truth of life that I seek
Personal gain, is well and good, so long as it is shared
as it should
This is how, I shall live my life, for it will end much of
my inner strife*

*Oh, subconscious mind, where do the memories lie,
so dear to me*

*Sing this song, so others may know
Where the truth of life belongs, that they should surely seek
And may these thoughts make them smile, and feel
good inside,
For all of life's while*

*Oh, subconscious mind, subconscious mind, if I pay attention
You can be so kind*

Joseph Westley Newman

Written by: Joseph Westley Newman
© Copyrighted, 1979, February 25,
by Joseph W. Newman

Let's examine another fact that occurred in the 1960's which constitutes further proof concerning the "Truth" of which I speak.

During the 1960's, hippie communities began appearing throughout several areas of the country. This occurrence in itself is not the point. *The significant fact is that many of the members of these hippie communities were from wealthy families.*

QUESTION: Why would children from affluent families leave home to live simply and without the material wealth into which they were born?

The answer is obvious. Such children had parents who were often too busy to offer them the love the children required and were offered instead material goods as substitutes for love. In response, the children recognized the unfair nature of this exchange and therefore rejected wealth in favor of the hippie communities' promises that love would be theirs for the asking.

In essence, those children born into wealth knew that the teaching which states, "Material wealth brings happiness," is a *falsehood*. They therefore sought happiness in a place essentially devoid of any material wealth.

It is ironic that children poor in material wealth but rich in family love often leave such love when they become adults and devote their lives to the acquisition of material wealth. Such occurs because these children have been taught that material wealth would (magically) make them happy. However, because they may have forsaken the "Truth" of which I write, such wealthy children from poor families become very unhappy. Subconsciously, they know that they have spent their lives in the pursuit of a *falsehood*.

FURTHER PROOF:

Offer a child (four years old or younger) who has received ample love from her or his parents the following:

The child can have all the material goods in the world but never see her or his parents again.

You will find that the young child will alarmingly scream that he/she "chooses the parents." It is in-

***"Only caring and sharing
human beings can bring happiness!"***

teresting that the loved child knows the "Truth" of which I write. This is because the young child has not been taught to accept the *falsehood* that material wealth would (magically) bring happiness.

The following proof is based on my observations of 48 years. This proof gives me great concern since I do not desire to contribute to the unhappy trend which I have observed.

When I was a boy, most families were financially what we would consider poor by today's standards. I have observed, however, that the love, devotion, and happiness within the poor families was considerably greater than the love, devotion, and happiness (or absence

thereof) which I observe within the families of this point in history.

These facts tell me that as creative technology advanced to reduce the drudgery and hardships of life, then love and happiness between family members decreased. This alarming trend would appear to violate common sense. A questioning mind will instantly realize that something in this formula of life is *wrong*.

What is wrong is the teaching that "material wealth will make one happy." This simply is not true! Only caring and sharing human beings can bring happiness! The achievement of material wealth should be sought only as a means to accentuate one's ability to care and share with others. Material goods are only capable of reducing life's drudgery for you and your loved ones. But in themselves, material goods do absolutely *nothing* to bring forth happiness.

EXAMPLE:

Place within a mansion replete with material wealth a married couple who do not "love" or "like" one another. If they are forced to spend most of their time within the walls of the mansion, it becomes a "prison" to the minds of that couple.

Place a man and woman who deeply "love" and "like" one another within the walls of a modest wooden house in the forest — a house containing minimum material wealth. *To the minds of this man and woman, the plain wooden house becomes a 'home.'*

If I can only instill within you the "Truth" of which I wish you to understand!

After years of dedicated effort on my part, the energy machine that I have innovated ***will mean nothing*** unless it serves to truly increase the happiness of all humanity. Please recognize the "Truth" of what I write in order that I not view my life's work to be a total waste.

With these same thoughts in mind, I will now comment on Marriage.

Most marriages are unsuccessful because children who become adults do not understand the "Truth" of life or marriage, since they have not been taught the "Truth" which I have referred to. A solid foundation for a meaningful marriage is simple.

EXAMPLE:

If a girl is considering marrying a boy, she should ask herself the following question: "If he were a girl, would I like her as a friend?" A boy should ask himself a similar question about his prospective bride: "If she were a boy, would I like him as a friend?"

You need only consider the true, close friends of your life to realize what this means. Please note that a true friend has things in common with you and both of you are sensitive to one another's problems.

If potential spouses have common "likes" and "dislikes," then they will be sensitive to one another's needs and endeavor as much as possible to participate together in many different activities.

Regrettably, many marriages are based not on “love” but rather “infatuation.” Within such a marriage, a couple may initially perceive themselves to be in love, even though they do not know or understand one another’s “true” likes and dislikes. After the flame of such “infatuation” diminishes, the “true” likes and dislikes of each become clearly known to one another. Such a cou-

***“True love represents, in essence,
an accumulation of many small things
over a ‘long time span’.”***

ple may unfortunately discover that they do not even like one another. Either divorce or an unhappy marriage will then ensue.

Ironically, such an unhappy marriage is not really the couple’s fault, since they have not been taught the “Truth” of what represents the basic and solid foundation of a good marriage: *Spouses must have things in common.* If they share in these and other things, then the love will grow throughout their lives.

True love — between a mother, daughter, son or father, man or woman, brother, sister, or grandparents — represents in essence *an accumulation of many small things over a “long time span.”*

The following is a song I wrote several years ago concerning this “Truth” of which I write: [Again, even if you do not appreciate this song, please sing it to your children. They will value the song and the fact that you are singing it to them.]

LASTING LOVE

*Lasting Love, is not a flash in the pan
Lasting Love, is holding your hand
Lasting Love, is sharing, unspoken words
Lasting Love, is accumulation, of many small things,
over a long time span*

*Lasting Love, is not a flash in the pan
Lasting Love, is sticking together through thick and thin
Lasting Love, is pulling together, until we win
Lasting Love, is accumulation, of many small things,
over a long time span*

*Lasting Love, is not a flash in the pan
Lasting Love, is caring and sharing
Lasting Love, is forgiving, when we misunderstand
Lasting Love, is accumulation, of many small things,
over a long time span*

*Lasting Love, is not a flash in the pan
Lasting Love, is doing together all we can
Lasting Love, makes friends, of each other
Lasting Love, is accumulation, of many small things,
over a long time span*

Joseph Westley Newman

Written by: Joseph Westley Newman
© Copyrighted, 1980, May 22,
by Joseph W. Newman

I ask that you teach your children the following to enable them to become content within themselves:

- (1) One of the most important accomplishments in their lives is to be able to provide a positive and favorable response to the question: “What do I really think of myself?”

Everyone in the world can tell you that you are great, but if you fail to experience within yourself wholeness, inner happiness, contentment, peace, love and the knowledge that you are doing your best to contribute to the future advancement of humanity, then you will still be unhappy.

However, if you experience a positive feeling within yourself with respect to these qualities, then you can endure the whole world thinking negatively about you. This occurs because you have a positive opinion of yourself. Moreover, you know that you are right and that the rest of the world is wrong.

- (2) The only elements in life continuously experienced on a daily basis which do not become boring are “true love” and Constructive Accomplish-

***“Therefore, dedicate yourself to pursuing the
quality of life and not the quantity of life!”***

ment or effort. These are the essences of life which are capable of fulfilling your being!

All other pursuits of a more egotistical or selfish nature become boring when done on a continuous, day-by-day, month-by-month, or year-by-year basis: sitting on a yacht, fishing, hunting, skiing, swimming, eating, receiving material gifts, sex, etc.

- (3) Those things in life which you find exciting or fun mean so much more when shared with someone you love and who loves you in return: a beautiful sunset or sunrise, stars in the night sky, beautiful mountains and valleys, forests and flowers, rivers and oceans, or entertainment and accomplishment.

Therefore, dedicate yourself to pursuing the quality of life and not the quantity of life. The former fulfills your inner being and the latter deceives and leaves your inner being unfulfilled.

Chapter 22

RECOMMENDED PROOF OF GOD'S EXISTENCE

I ask that all people read and question what I write, and especially those who do not believe in God.

I was raised a Protestant, joined the Church, and was baptized at the age of eight. I believed in God because I had been taught to do so.

My ever-questioning mind would not be quiescent, however, and as the years passed I began to doubt there was a God. The major reason: my inner being was deeply hurt when I witnessed the misery and injustice throughout the world, especially in the eyes of young children born into misery.

I asked myself the question: "If I hurt so deeply inside, how could a God (who would be infinitely more sympathetic to such suffering than I) permit such merciless injustice to occur?" I was unable to find a satisfactory answer to my honest question. Consequently, as the years passed, I ceased to believe in God. I did not desire a "pie in the sky," and I did not wish to hold a false belief. My sole purpose was to do good, and I had vowed to myself that I would not be content until I had achieved a beneficial improvement for humanity. [Refer to my letter to President Johnson in 1967 at the beginning of Chapter 20.] At the time, I also continued to question and to seek proof or disproof of God's existence — not for others, but for myself. Such questioning stimulated me to write a discussion on the "Soul," dated May 16, 1978:

THE SCIENTIFIC EVIDENCE OF THE "SOUL"

1. The soft mass of the adult brain is perfectly motionless. It does not contract, divide or grow — yet it consumes up to 25% of the body's oxygen supply and 20% of the body's blood supply — while it comprises only 2% of the body's weight. Evidently, great amounts of energy are consumed in the production of mental life, but exactly how is not known!

2. All material parts of the body can be efficiently affected by touching an electrode in a limited portion of the brain — such as sight, sound, thirst, hunger, sex drive, fear, anger, body movements, etc.

"I believe in one God, and no more; and I hope for happiness beyond this life."

— Thomas Paine
from his book, *The Age of Reason*

2A. However, memory and thought cannot be pinpointed or efficiently affected by touching an electrode in a limited portion of the brain. Experiments have even been conducted on rats that were previously taught to go through a maze, and then systematically remove more and more of the brain — the rats would still always attempt to stumble through the correct path of the maze!

2B. The conclusion I draw from these experiments implies that the brain is considerably more unique in acquiring meaningful knowledge than in the functions of the material body.

3. I, therefore, conclude that the brain is considerably more concerned about gathering and retaining knowledge in the brain than it is in the functions of the material body that are the mode of motorization for the brain. I have personally experienced a body temperature drop on many occasions when in deep creative thought.

4. This is, indeed, scientifically curious.

4A. Is the brain seeking, finding and retaining knowledge for better protection of the material body or for some other unobvious reason?

4B. This raises the question — is the body better protected by most of the brain devoted to speed, strength, and repairing of cells and bones or as the brain exists today which is superior to such a limited function?

4C. Looking around the world, it is very obvious that there are many animals faster and stronger than humans; however, there are none that can protect their physical bodies as efficiently as humans.

4D. Therefore, I draw the conclusion that the brain senses that the body is better protected by the gaining of knowledge and, therefore, stimulates the body to find knowledge. This is easily observed in most all small animals, as they are always curious.

5. The gaining or seeking of Wisdom is less motivated in most human or animal brains. Most humans gather

knowledge for the betterment of their material bodies.

5A. This is very curious because it is very obvious from all of the vast evidence presented in life that material things or possessions, such as food, cars, planes, boats, houses, fame, sex, etc., do not make the human brain content very long or give it a feeling of tranquility for any length of time.

5B. It is also very obvious from all of the vast evidence presented in life that meaningful thoughts, such as love, deep creative thinking and constructive religion does make the human brain content and gives it a feeling of tranquility for infinite time, so long as these thoughts are uppermost in the brain.

5C. Scientifically, this is very interesting! It appears that the human brain is only truly satisfied in those thoughts that are beneficial for a lasting time to more than one brain! Does this mean that the brain seeks to produce — invent — goodness and then multiply or reinforce this goodness with the merging with other sources of goodness — knowing that the desired feeling is increased?

5D. Looking at these facts, I draw the conclusion that if there were made available an energy source that would eliminate the need for the human mind to feel the necessity of spending the largest portion of its time working for material gain, there would be a resulting increase in desire for the human mind to produce those creative thoughts most conducive to a lasting feeling of tranquility, if given the proper guidance.

6. It has been my own personal observation of myself that when the brain is learning knowledge — study, experience, etc. — the brain absorbs this knowledge without a “High Elated Feeling,” at this point it has a more computerized attitude.

6A. However, when the brain then takes this knowledge and strives to be creative, thereby entering into deep thought — the brain then experiences a “High Elated Feeling.” I have experienced this feeling to such a high extent that I have described it to others as a feeling completely separate and independent from earthly substance. I have never experienced this completely satisfying feeling in any other experience in my life, not sex, dining, athletic accomplishments, receipt of monetary value or any other. This feeling is more closely related to love or constructive religious thoughts, but to me, personally, it has been even higher because the feeling has been so completely pure — there are no doubts that cross the mind, there is only the feeling of completeness, an absolute unawareness of earthly substance.

6B. From 469 - 399 B.C., there was a truth-seeking individual named Socrates. On the day he was to be put to death for his beliefs, he carried on a discussion with some of his followers as to whether the body had a Soul. This discussion was based on logic deduced from limited scientific information and observations of that time.

6C. The paragraph that follows is a statement of Truth made by Socrates on that day which has inspired me greatly, as the statement is still Absolute Truth to this day:

“And thought is best when the mind is gathered into herself and none of these things trouble her — neither sounds nor sights nor pain nor any pleasure — when she takes leave of the body, and has as little as possible to do with it, when she has no bodily sense or desire, but is aspiring after true being.”

6D. Prior to reading this statement, I had stated to others I doubted that I had a Soul, because I was not mentally aware of my Soul, nor could I scientifically point out its separation from the material body, which included the mind. Immediately upon reading Socrates' statement, I related to my own personal experiences and statements concerning deep creative thought. I then quickly questioned, does this then mean that I have been aware of my “Soul Entity” without realizing it?

6E. In 1968, at a time when I felt that I did not have a Soul, I wrote this statement that I derived from deep creative thought as to all matter and the Human Mind: “It does not seem improbable to me that the Human Mind is capable of feats that have not been imagined.” Coupling this statement with my present statements, I now realize that I had concluded the possibility that the Human Mind may create its “Soul.”

6F. This raises the question, When does the Soul enter the mind of a human? Religion teaches the “Soul” is made Good or Bad by what you think. Therefore, if this is a true statement — the scientific conclusion is that the mind surely develops the “Soul,” probably not unlike the process that the physical body develops, but taking much longer for real development as to being a Good or Evil “Soul” — and being in a state of limbo until such thinking processes are established.

6G. Therefore, the scientific conclusion I draw from these thoughts is that if the “Soul” is developed by the mind at a time later and independent of the material body, then it would possibly continue to live for a period of time after the death of the physical body.

7. As a Scientist who searches for Absolute Truth in All Things, it pleases me to state that the True Scientific Facts of life relative to the Human Existence indicate that there is a development in the human mind — when pointed in the right direction — which causes the human mind to strive to obtain a mental state of existence separate and independent of the material functions and needs of the Human Body, which is not unlike the Entity named the “Soul” of religion.

Joseph Westley Newman

May 16, 1978

EDITOR'S NOTE: There will undoubtedly be those in the present scientific community who do not understand Mr. Newman's rationale for including in this published work a "discussion on God." However, it should be historically noted that even the great physicist Isaac Newton chose to include a discussion concerning "the nature of God" in BOOK III of his scientific masterpiece PRINCIPIA MATHEMATICA.

Mr. Newman considers his "discussion on God" to be inseparable from the presentation of his other scientific theories and technical processes. Moreover, as a result of the societal crisis presently confronting our species, it is important to Mr. Newman that these concepts be published in their entirety at this time.

Approximately one or two years prior to writing "The Scientific Evidence of the 'Soul,'" I began to state this single prayer: "God, if you exist, make me know it relative to the mind you have provided me." I asked nothing else, and I made the statement silently and periodically over a year's passage. I felt it would not demonstrate sincerity on my part to state it only once or twice.

In order to appreciate what I am preparing to share with you, I must assure you that I am a totally factual and non-superstitious individual.

During 1978, the mathematical number "14" became repeatedly and compellingly fixed in my mind. In response to this mental input, I asked Ellen, my devoted wife, to record the number "14" in a written log and to remember it.

Remarkably, important business transactions and other significant events began to arrive consistently at a satisfactory conclusion on the 14th day of varying months and years. This process has continued through April of 1985.

For the first time in 1984, I disclosed this fact to other business associates and they marveled when they independently witnessed several significant events consummate for me on the 14th day of the month. [I must stress that I did not influence or plan these events in any way. Such events were planned by others at their own instigation.]

The mathematical probability odds of these events consistently occurring on the 14th day of the month over a seven-year period on a coincidental basis are staggering. There exists a complete and recorded log of all such occurrences.

I must also stress to you that I sincerely doubt *any* human being would have convinced me that God exists. However, because of these and many other related actually-recorded events, I must follow the dictum of Shakespeare when he said:

"To thine own self be true;

And it must follow as the night the day,

Thou can'st not then be false to any man."

Because of this attitude I now know there is a God and that God has been kind to me in my stubbornness to seek

"Absolute Truth." God answered my request in a factual manner exactly in accordance with the scientific manner in which my mind and my life function.

As a truthful scientist, my mind responds to factual circumstances that consistently repeat themselves. Like a magnet, such signs and signals attract my scientific mind and direct my deep attention to the pertinent subject matter.*

I always keep my word to any human being. I most certainly keep it with my Supreme Being!

I now pray the following: "God, give me the knowledge and wisdom to draw all peoples of this Earth to you and not the first one, no, not the first one, away from you."

In the beginning, God did not "reveal everything to humans," but did bestow upon us "Free Will" and the mental ability/desire to question and seek to totally understand the nature of the Universe. Use the divine abilities to the maximum and you will benefit both yourself and others.

Concerning my earlier question with respect to the misery of innocent individuals throughout our history on this planet: Such misery is created by humans and the actions (or lack of actions) by humans. All problems on this Earth can be solved if we first question and then work to seek a solution to the problems.

"Pure" love and "pure" actions are not "pure" if they are forced — they must be offered and performed via the exercise of one's Free Will. I can understand God not desiring anything that is not reflective of Truth. Personally, I feel exactly the same way. If I cannot depend upon someone, then I strongly prefer to stand alone since I realize that I can depend upon myself. Moreover, I want no part of something or someone's actions which are not true. I can only ask, "Why should anyone want someone who is false?"

We are false if we do not truly care about our fellow human beings. We can solve any problem that we "set our mind to." If misery exists upon this planet, then we have only ourselves to blame, not God.

The greatest gift God has given us is our "Mind" — for even the mind is the essence of the "Soul." Whether the "Soul" is good or bad depends solely upon the "Mind."

If God gave us such a powerful tool as a "Mind," then it should be obvious that God expects us to use the "Mind" for *good*, not evil, and that one's "Mind" should not be complacent, unthinking, or unquestioning. With such a powerful God-given gift as the "Mind," we must place the blame for the misery throughout the world upon ourselves, not God.

It is evident to me that we must have Free Will. How else could we demonstrate pure and voluntary love to

*I have an extensive log book containing all recorded events relating to the number "14." I am not including these events [which number over fifty] in this Book, since I believe most people would only view such events as extraordinary coincidences. The significance of the number "14" has much importance to me, but such significance is not proposed as a "proof" for God's existence. The specific recommended "proof" will follow later in this Chapter.

God? If we were fashioned by God as “robots” which were fully programmed to do good and eliminate misery from the Earth, then not only would our actions be meaningless but our very existence would be equally meaningless.

I ask you: “Would you wish to replace your loved ones with robots?” Of course not. The difference in the mental significance between “loved ones” and “robots” is phenomenal. The “pure love” within our “loved ones” touches our inner being; the intelligence of a robot is only a result of given materials which may be easily replaced. A robot may even be programmed to “love” and “care” for you. However, you would know that such robotic actions are false and do not represent “pure love.” Your inner being would not be content with a “loving” robot since the essence of such an arrangement would be *false*.

If one seeks Absolute Truth via a questioning attitude, then one should clearly understand and be sensitive to why God provided us with a “Free Will.” In striving for Absolute Truth, one should possess the intellectual honesty to recognize that the responsibility for the human misery upon this Earth lies with us — not God.

I am totally certain that if we apply our minds to understanding nature, we can solve any problem upon this Earth. Do not belittle yourself and blindly say, “No, such cannot be accomplished.” Such an attitude is but an unknowing rejection of the unjust teaching system in-

“I am totally certain that if we apply our minds to understanding nature, we can solve any problem upon this Earth.”

herited from the past.

I urge you to have the intellectual honesty to admit to yourself that God has provided you with a powerful and leveraged entity: the MIND. God expects you to utilize such a MIND for beneficial purposes and to demonstrate *pure love* on the basis of your “Free Will.” Such “Free Will” represents *Absolute Truth*. When such occurs, we will have shown that we are able to be with God. Anything less than such demonstrable actions is *false* and constitutes a *lie*.

QUESTION: Why does a loved one, who may be a good and decent individual, suddenly and unexpectedly die?

While I do not know the answer to this question for certain, I do sense that “Free Will” is the major factor in such an occurrence.

EXAMPLE: What would happen if you jumped without a parachute from an airplane flying at 20,000 feet and you landed on concrete? There should be no doubt in your mind what would occur. At the very least, serious and possibly permanent injury would occur. Far more likely — you would be killed.

Certainly we would not use our “Free Will” to perform such an obviously foolish action unless suicide is our intent. However, if we were to do so, we would not expect God to stop us.

Think for a moment and question your own mind concerning the *Truth* of what I have just written. Consider also the fact that insurance statistics prove most accidents are preventable and represent the results of an unthinking, unquestioning, and complacent attitude of “Free Will.”

Carefully question and consider the above statements: let’s proceed to seek *Absolute Truth*.

God has provided us with “Free Will” as well as a powerful MIND, and God expects us to utilize our MIND without complacency or evasion of responsibility for accidental deaths as a result of fire, collisions, storms, earthquakes, guns, floods, disease, etc. Such is true because we are responsible for understanding and formulating the Laws of Nature. Moreover, the history of science demonstrates that we can solve any problem to which we address our minds.

QUESTION: If we care so little about ourselves — which demonstrates a lack of self-respect, a lack of the responsible application of “Free Will,” and an insensitivity to the precious gift of a powerful mind — then by what logic can we expect God to be responsible for our own incompetence?

If we seek Absolute Truth, then we must place the blame solely where it belongs: upon ourselves.

If one wishes to solve a problem, then one must first admit that there is a problem. One must then pinpoint the problem and solve it by asking, “How, What and

Why,” via God’s precious gift to us: our Mind.

With regard to the implications of self-responsibility for the use of our Mind, let’s discuss different religions.

EXAMPLE: In previous years, many religious doctrines taught that the Earth was flat, that the Earth was the center of the Universe, was orbited by the Sun, planets, etc., and that all celestial objects were “perfect spheres.” Religious doctrine also taught that plagues, storms, earthquakes, volcanic eruptions, etc. were acts of God, representing retribution for our sins. We were also told that “if God wanted man to fly, God would have given him wings like the birds.” We were instructed not to question anything taught by the various Churches.

It is true that the above teachings are and were *totally false*. The facts demonstrate that God did not say these teachings. The question is then raised, “Who did say these statements?” The truthful answer: “Man!”

There are many different religions with separate teachings throughout the world and dozens of orders, congregations, and sects even within a single denomination.

FACT: God’s word is *pure* and represents *Truth*.

QUESTION: In an effort to justify the confusing result of so many religious teachings, who has said that God has stated so many varying pronouncements?

ANSWER: "Man!"

QUESTION: Who has written the scriptures of the world's religions?

ANSWER: "Man!"

QUESTION: Does God teach us to hate and kill?

ANSWER: No! God teaches love, caring, and forgiveness.

QUESTION: Who has taught (or teaches) the justification for religious wars which serve to generate hate, death, and revenge?

ANSWER: "Man!"

To those who may feel uncertain or uncomfortable with what I write, I warmly ask that you truthfully question my statements since I am only a mere man. However, if you do this (as you should), then you should also truthfully question what you have been personally taught by any man or woman.

I write to you only of my love for *Absolute Truth*. The very essence of my being has always, yes, always, cried out: *Seek the "Absolute Truth" in all things and the Truth will set you free!*

As Thomas Paine so elegantly wrote in his *Age of Reason*:

*"THE WORD OF GOD IS THE CREATION WE BEHOLD and it is **this word**, which no human invention can counterfeit or alter, that God speaketh universally to Man."*

I believe in God not because of the word of any man or woman, but because I sought *Absolute Truth* and I was committed to follow the trail of such *Absolute Truth* to its end, regardless of whether such a trail proved or disproved the existence of God.

My very essence said to me that if God does exist, then God is Truth and such a God could endure subjection to any honest question I ask in obtaining *Absolute Truth*.

It warms my being to be able to inform you that God is Truth! Moreover, such a God can withstand any honest question.

Only a mere man or woman is capable of hiding in the cloak of darkness and despises serious questioning of the biased and prejudiced untrue rhetoric which flows from her or his mouth.

God exemplifies confidence and *Absolute Truth* via the very essence of my own being. I realize that God has bestowed upon me a questioning mind and a bulldog determination to pursue and find the Truth. To those who believe in God, it should be obvious that I have retained this precious God-given gift of a questioning mind and that God gave it to me because God expects me to use it.

God exemplifies his confidence and *Absolute Truth* to you since all healthy young children have the precious

God-given gift of a questioning mind. The facts I have presented in Chapter 21 demonstrate that children are unjustly taught by school systems and religious denominations to forsake their God-given gift of a questioning mind. The facts also demonstrate that the "fear of questioning" is a result of the influence of mere men or women.

God is Truth and God has no fear of Truth. *Absolute Truth* can **only** be achieved by sincere questioning! The blind, non-intellectual, unquestioning mental acceptance of teaching or dogma from whatever source, will only result in the acceptance of falsehood born of the biased, prejudiced attitudes of mere men and women.

I write and speak this *Truth* to all men and women of the world. It is my sincere purpose to teach one to *think*; one can correctly *think* by honest questioning.

"The blind, non-intellectual, unquestioning mental acceptance of teaching or dogma from whatever source, will only result in the acceptance of falsehood born of the biased, prejudiced attitudes of mere men and women."

At this point, I wish to share with the reader a proof of God's existence via my simple prayer: "God, if You exist, enable me to know it relative to the mind You have given me."

Several years ago, a sincere, God-respecting business associate advised me to purchase a Bible and read it. He claimed that by so doing, I would have no doubt of God's existence. I did as he suggested, and as I read the Bible, I discovered many conflicting statements. (I will not discuss these statements, since it serves no constructive purpose.)

As I read the Bible, I felt deep dismay because I wanted to believe in God's existence. However, in my endless desire for *Absolute Truth*, I could not complacently and blindly accept what I read. One thought rushed through my mind: the Bible was the one place where I would not expect to find error and conflicting statements if it truly represented the Word of God.

Suddenly, my mind "received" a powerful, scolding message: "Get up and do what you do best!" Instantly, I knew what to do. I went to my library which contains numerous books describing countries throughout the world. I rigorously researched the *essence* of religious doctrines throughout the world.

In studying such doctrines, I discovered a dominating, clear, and unquestioning *Truth* which made itself apparent to the purity of my rigorous questioning mind — a mind always searching for *Absolute Truth*. The Truth I discovered is the following:

Any conflicting statement or falsehood within the Bible, teachings, or doctrine of any religious sect, represents the mistake of MAN, not GOD.

History demonstrates that anything "touched" by mere man or woman is contaminated by their own

biases and prejudices. Bibles are no exception to this rule. Like textbooks which contain incorrect statements, I do not recommend that one dismiss the *entire* Book. There are valuable Truths in the Bible! The same is true for the various bibles of religions throughout the world. You should only dismiss what is *False* and retain what is *True*. Teach such Truth to your children.

The following is the true essence of all religions in the world:

“Do good, think good thoughts, care for others, and do not steal, kill, etc.”

This basic common denominator of the “teaching of Goodness” which I found evident in all religions, represented a tell-tale sign to my questioning mind. Such a common denominator is unlikely to be accidental. To my questioning mind, this “teaching of Goodness” had a purity that was majestic and distinct from the biases and prejudices of mere man or woman. Such a consistency of “Goodness” is what I would expect from God, who I know is “merciful.”

I thus perceived a logical reason for the existence of different religions throughout the world. At different times, God had instructed special individuals to teach the essence of God’s love, as well as to live and maintain such love on a consistent basis.

History had demonstrated that God’s Word was not quickly taught throughout the world. Consequently, God commissioned individuals familiar with their respective customs in different parts of the world to teach the essence of God’s love to people with varying ethnic and cultural backgrounds.

QUESTION: What would you do if you hired someone to perform a particular task and you found they were unable to maintain or complete the total task as required?

ANSWER: If you believed that the individual was providing her/his best effort, you would very likely secure additional assistance to complete the job. In effect, one would have separate contracts with various individuals to effect the same task. One would expect that each individual would honor the terms of their respective contract.

QUESTION: Does it not seem reasonable that God would act in some fashion if a task God sought to achieve was not being accomplished?

EXAMINE THESE FACTS:

- (1) **BUDDHISM** — a doctrine whose message is *Goodness*, with the following intended result:
 “The reality beyond all change and suffering, it is peace, security, supreme joy, unspeakable bliss.”
- (2) **HINDUISM** — a doctrine whose message is also *Goodness* and the words of the incarnate god Krishna, who says:
 “Whatever god a man worships, it is I who answers the prayer.”

(3) **ISLAM** — a doctrine whose message is also *Goodness* and a belief in one God. The name “ALLAH” is used by Muslims and Christians.

(4) **JUDAISM** — a doctrine whose message is also *Goodness* and a belief in one God.

(5) **CHRISTIANITY** — a doctrine whose message is also *Goodness* and a belief in one God.

I will take the liberty of quoting the Biblical Peter, chief of the twelve apostles, and Jesus, who understood the true message of God:

“Then Peter opened his mouth, and said, ‘Of a truth I perceive that God is no respecter of persons: But in every nation he that feareth him, and worketh righteousness, is accepted with him.’”
 [ACTS 10:34,35]

And Jesus himself said:

“Blessed are the pure in heart: for they shall see God.”
 [MATTHEW 5:8]

Once again I repeat my constant prayer:

“God, give me the knowledge and wisdom to unite all people of this Earth to you and not the first one, no not the first one, from you.”

The evidence has proven to me that at various times and places God has ordained and chosen Special Good Individuals by endowing them with the Spirit of God for the purpose of teaching “God’s Goodness” to all God’s people on this Earth. However, none of these chosen individuals were or are superior or equal to God. God is Goodness, Supreme, and represents the purity of *Absolute Truth*.

Those who have been chosen by God to teach God’s word have admitted that they are neither equal nor superior to God. As an example of this fact, I quote Jesus:

“Believest thou not that I am in the Father, and the Father in me? The words that I speak unto you I speak not of myself; but the Father that dwelleth in me, he doeth the works.” (Emphasis added.) [Quotation from ST. JOHN, Chapter 14, verse 10. The number “14” as I have discussed is very significant to me but not necessarily to anyone else. This quote was brought to my attention after I noted the significance of the number “14.”]

The following quotation is from ST. MATTHEW, Chapter 27, verse 46 (similar to a quote from ST. MARK, Chapter 15, verse 34):

“And about the ninth hour, Jesus cried with a loud voice, saying, ‘Eli, Eli, lama sabachthani?’ that is to say, My God, My God, why hast thou forsaken me?” (Emphasis added.)

Such a quotation demonstrates that Jesus was certain that God's Spirit dwelt within him and therefore he called upon God.

Although the Special Individuals chosen by God were not actually God, this fact does not distract from the *Absolute Truth's* essence of God, "Spirit," and the essence of God's Goodness mirrored from such individuals. The facts of history demonstrate that if God exists then these Special Individuals must now exist with God. To believe in such Individuals and the essence of what they teach (whichever religious doctrine) is to believe in God.

Such Special Individuals were chosen by God for the exact purpose of providing a means for other individuals to make a covenant with God! Moreover, God expects one to honor such a covenant.

Quoting again from Jesus and the apostle Peter, who understood God's true message, Jesus said:

Blessed are the pure in heart: for they shall see God."
[MATTHEW 5:8]

"Then Peter opened his mouth, and said: 'Of a truth I perceive that God is no respecter of persons: But in every nation he that feareth him, and worketh righteousness, is accepted with him.'"
[ACTS 10:35]

I perceive that God wishes all people upon this Earth to live together in peace and harmony. I also perceive that all religions which recognize God's existence have been instructed by God to teach "Goodness." Since the killing of one another is not sanctioned by God, who teaches and/or sanctions such action? ANSWER: "Man!"

In accordance with God's teachings, all war should permanently cease. Moreover, all religious individuals should love one another and share their love with non-believers.

Not because of man do I believe in God, but rather because God was kind to me during my determined efforts to seek *Absolute Truth* by providing me with overwhelming "proof of God's existence relative to the mind God has given me." I will endeavor to demonstrate equal proof to other "non-believers," as well as to those religious individuals who have ever experienced "doubt" concerning God's existence. Such attitudes are the result of worldly experiences.

After years of study, thought, and questions during my relentless search for *Absolute Truth*, I asked myself a question:

"Surely God realizes the imperfections of mere man or woman and surely God has developed a *pure and factual proof* of God's existence totally independent from the contaminating influence of mere man or woman?"

I was convinced that such a factual proof must exist. But where would I find such a "pure proof?" At that

moment in my life a "comfortable and knowing" thought entered my mind:

"Examine the 'Speaking in Unknown Tongues.'"

Although I was raised a Baptist, I immediately felt confident concerning the Truth of this thought. The "Speaking in Unknown Tongues (Languages)" was not taught or practiced in the Baptist Church. Moreover, such action would not have been countenanced in the Baptist Church. I have never spoken in "Unknown Tongues (Languages)," nor have I ever had the desire (prior to this time) to speak in "Unknown Tongues (Languages)." However, without such an experience I nevertheless sensed within myself a thought that the "pure proof" of God's existence would be found via the "Speaking in Unknown Tongues."

I disclosed this thought to a California business associate who responded by sending me a book entitled, *They Speak With Other Tongues*, by John L. Sherrill. I proceeded to read the book in an effort to discover scientific facts.

On page 25 of the book, John Sherrill asked the preacher of a small church whose members practiced "Speaking in Unknown Tongues" to indicate the source of such worship. "Why, from the Bible," he said. "The last part of FIRST CORINTHIANS, Chapter 14." (Emphasis added.)

In this instance, the mention of the number "14" had *double* significance for me (although not necessarily to anyone else): (1) the earlier references to factual experiences which had consummated for me on the "14th" day of various months and (2) my search for a "pure proof" of God's existence had led me to Chapter "14" of FIRST CORINTHIANS.

There are 16 Chapters in FIRST CORINTHIANS. The odds are 16 to 1 against "14" being the Chapter which would be of unusual significance to me. However, when such odds are multiplied by the many additional events in my life relating to the number "14," I know that my becoming aware of "The Speaking in Unknown Tongues" is neither accidental nor coincidental.

Although I'll never humble my "Will" to any man or woman upon this Earth, I'll gladly humble my "Will" to the "Purity of God" and the "Goodness" that God represents.

FIRST CORINTHIANS, Chapter 14, verse 22, states:

"Wherefore tongues are for a Sign, not to them that believe, but to them that believe not: but prophesying serveth not for them that believe not, but for them which believe." (Emphasis added.)

As I searched for "Facts" within *They Speak With Other Tongues*, by John L. Sherrill, the more knowingly I perceived the Truth of the "pure proof" for God's existence via "Unknown Tongues." Such an activity as "Speaking in Unknown Tongues" is totally independent of contamination by mere man or woman. Examine the following facts to understand why this is true:

- (1) Between 1926 and 1936, a significant impact of the spiritual power involved with "Unknown Tongues" was demonstrated: the traditional churches lost

two million members — 8% of their total membership. During the same period, Pentecostal membership increased:

PENTECOSTAL ASSEMBLIES — up 264.7%

ASSEMBLIES OF GOD — up 208.7%

CHURCH OF GOD — up 92.8%

[Statistics from page 50 of *They Speak With Other Tongues.*]

- (2) In the past, traditional Churches have coolly received the Pentecostals due to the latter's doctrine of "Speaking in Unknown Tongues." However, as a result of the phenomenal results obtained by the Pentecostals, many important traditional Church leaders such as Billy Graham have been quoted as recognizing God's influence via the Holy Spirit (Speaking in Unknown Tongues). [See pages 64-67 of *They Speak With Other Tongues.*]

Some Traditional Churches would still be uncomfortable with the demonstration or thought of demonstration of "Speaking in Unknown Tongues" within their own congregation. This is because the actions of the individual who "speaks in unknown tongues (languages)" cause him to appear foolish and totally degraded.

As an eight-year-old, I can recall when I once visited a Pentecostal Church with a friend. I had never heard of "speaking in unknown tongues" and I remember how shocked and stunned I became when I watched a twelve-year-old girl suddenly stand and begin to jump about while loudly blabbering in a totally unintelligible fashion. As a young boy, my immediate reaction was to laugh — so much so that my young friend also began to laugh, even though it occurred in his own church. The adults sitting in our vicinity began to sternly hush us.

I never returned to that Pentecostal church. Such strange behavior was totally foreign to the strict and rigid Baptist posture where one's parents would admonish one to "be still" if one twisted or squirmed in the pew; one was also forbidden to speak during the Church Services.

However, I can now comprehend internally what that boy of eight only visualized externally. Such is the case because I now have "Free Will." I recognize the God-given power of the mind, and I seek *Absolute Truth*.

It is true that members of traditional Churches have coolly received reports of those individuals who "speak in unknown tongues (languages)" and physically act foolishly and degradingly by jumping, shouting, rolling on the floor, etc. However, in one sense, such "degrading" actions are "beautiful" because they establish a *purity* not likely to have been contrived by the contamination of man. Conversely, such *purity* does indeed demonstrate God's spirit.

I am fully aware that the reader will be tempted to totally dismiss what I now write as foolish, ridiculous, and irrational. However, I implore you to utilize your questioning mind and recognize the *Truth* of what God demonstrates by such belittling and seeming degradation of the mere physical body. Such a body is only the *glitter* and not the *substance* of the "Soul." That such is the

case is obvious to me since I described earlier the same effect from a totally different approach. Refer to my article entitled "The Scientific Evidence of the Soul," in which I state:

"As a scientist who searches for *Absolute Truth* in all things — it pleases me to state that the true scientific facts of life relative to the human existence indicates that there is a development in the human mind — when pointed in the right direction — which causes the human mind to strive to obtain a mental state of existence separate and independent from the material functions and needs of the human body, which is not unlike the entity named the 'Soul' of religion."

(Emphasis added.)

One should recognize the fact that the Mind (Soul) demonstrates an existence separate and independent from the human body via the unorthodox actions of individuals who "speak in unknown tongues (languages)."

Examine the scientific significance of this recommended proof of God's existence. Begin with an individual who is taught to have self-respect, proceeds to "speak in unknown tongues" and, as a result, totally belittles and degrades the importance of one's physical body by one's unintelligible actions. After exhibiting such behavior, one would expect that the individual would be ashamed, embarrassed, and sad for behaving so before others.

However, the facts consistently demonstrate that those individuals who truthfully "speak in unknown tongues" feel blessed, close to God and are grateful for the experience. Many such individuals have reported feeling within themselves a new source of energy which lasts for months.

Such psychological results are *totally* opposite to what one would expect.

If one could "bottle" the end result of BLISS and market it, there would be a stampede to purchase such an elixir. Dope and alcohol would instantly be forgotten!

It is my intent to use my God-given gift and prove God's existence by tape recording those who "speak in unknown tongues (languages)" and convert such sounds into electromagnetic impulses which can be observed on an oscilloscope. With the assistance of linguistic experts, I would endeavor to identify the audio and conceptual order of the sounds produced by those who "speak in unknown tongues (languages)." I believe instinctively that God has provided such an order capable of being detected by the Truthful, questioning mind for purposes of providing an Absolute Proof to those who disbelieve the existence of God's presence within our lives.

In pursuit of scientific Truth, author John Sherrill arranged a meeting at the Columbia University Faculty Club, and had six linguists listen to an approximately one-hour tape recording which featured individuals who were "speaking in unknown tongues (languages)." [Refer to pages 100-103 of *They Speak With Other Tongues.*]

Although the linguists were unable to identify any

specific languages on the recordings, Sherrill writes that “they had frequently identified *language patterns* on the tape.” In an attempt to fool the linguists, John Sherrill had intentionally recorded two deceptive sound sequences under normal circumstances. These sequences were intended to resemble the voice quality of an individual who was “speaking in unknown tongues.”

At the Columbia University meeting, the six linguists quickly detected the two fake sound sequences. According to John Sherrill:

“The ‘shape’ of real language, the variety of sound combinations, the infrequency of repetition, and so forth, is virtually impossible, so they (the linguists) said, to reproduce by deliberate effort.”

The linguists added that there were over 2,800 known languages and dialects spoken throughout the world today, and the odds against the recognition of a particular language were enormous.

I feel certain that this recommended proof of God’s existence can be accomplished and electromagnetically documented.

I warmly recommend that all churches and religions throughout the world encourage the “speaking in unknown tongues (languages)” in a purposeful manner which complements the power of our God-given mind. If one were to introduce scientific technology into this process, then one could simply construct “seat-belted chairs” which would automatically restrain an individual filled with the Spirit of God. Such a mechanism would improve personal safety, improve posture, and would restrain those physical movements which distract from the phenomenal experience.

With such physical restraint, those who are not “filled” with the Holy Spirit may then observe the physical manifestations reflecting the inner being (Soul) of the individual who “speaks in unknown tongues” (languages) without distraction from physical body superficialities. Such superficialities do not reflect the substance of the “Soul.”

I am confident that good design engineers could construct a proper restraining seat; moreover, with the introduction of visual dramatics to enhance the effects of the experience, such engineers could utilize a discrete electrical and/or hydraulic system to enable the restraining seat to physically rise several feet above the floor. By surrounding this seat with “white veils, etc.” one could metaphorically represent the “Purity” of God’s Spirit which resides within us all. Such an arrangement would permit all observers — as well as the person “speaking in unknown tongues (languages)” — to participate in the splendor of the moment.

To avoid deception by mere man or woman, NASA-developed, heat-sensing and pulse/blood pressure monitoring devices could be installed within the special seats. The seat would not mechanically rise unless all pre-programmed instruments psychologically indicated that the experience was genuine (from God) and not induced by mere man or woman. A pre-programmed computer integrated with an oscilloscope and EEG machine

could monitor both linguistic output and brainwave pattern to reduce or eliminate the possibility of deception.

Recently I spoke with a woman who is the mother of several grown children and was formerly a strict Baptist. Approximately five years ago, she began attending a Pentecostal Church as a result of her teenage daughter’s experiences at the same Church.

The good woman informed me that she had prayed in the following manner to God: “While I do not understand the nature of one who ‘speaks in unknown tongues,’ if it *is* real then I wish to share the experience.” Within a short time, according to the good woman, she experienced the “speaking in unknown tongues (languages)” on a number of occasions.

I asked her the following question: “After such an experience, what was the intensity of your ‘closeness to God’? Was the intensity the same, slightly greater, significantly greater, or tremendously greater?” Without any hesitation, she vigorously stated that she had felt “tremendously closer to God!”

She added that her son — a man in his early twenties — had recently told her that “he could never return to the Baptist Church because it simply did not provide him with what he needed.” I am convinced that their respective responses would have been identical had they originally belonged to any other traditional Church. [I do not write this to derogate other traditional Churches, but rather to encourage them to honestly and sincerely examine the phenomena of those who “speak in unknown tongues (languages).”]

I am convinced that it is necessary to scientifically corroborate the unique nature of those who “speak in unknown tongues (languages).” In the above discussion, I have offered a technique to accomplish such corroboration. While personal opinion and experience is valuable, it is still necessary to subject the “speaking in unknown tongues (languages)” phenomena to the rigors of the scientific method. It is my hope that the discussion on this subject within the context of this Book will encourage honest, scientific investigation of this phenomena.

It is true that I have never spoken in unknown tongues (languages). Although I sincerely advise others to attend the religious institutions of their choice, I should state that I do not physically attend any particular church. In this sense, my personal approach is perhaps similar to that of Thomas Paine who once wrote: “My own mind is my own church.”

However, I am certain that God has provided me with the gift of a questioning mind. The facts that I have discovered and my awareness of God’s existence convince me that the good woman speaks the *Truth*.

To quote once again from *They Speak With Other Tongues*, pages 65 and 66:

“Father Daniel J. O’Hanlon, Professor of Theology at Alma College, Los Gatos, California, wrote an article for *America*, the national Catholic weekly, in which he said:

'Few Catholics regard Pentecostals with little more than amusement, if they take notice of their existence at all. Even most Protestants keep their distance from these unconventional Christians and find it difficult to say anything good about them. Nevertheless, the rapid growth of the Pentecostal movement all over the world and the extraordinary appeal it has for the kind of people to whom our Lord especially addressed Himself, the poor and dispossessed, should warn us to put aside our squeamish bourgeois prejudices and take a long, hard look at it.'

The evidence before me indicates that not only is the unbeliever converted into a belief in God after the "speaking in tongues" experience, but even conventional believers in God greatly benefit by such an experience. Such conventional believers are drawn closer to God and experience an intimate feeling concerning God's reality.

Quoting from page 140 of *They Speak With Other Tongues*:

"Not long ago, I talked with Dr. John Alexander MacKay, President-Emeritus of Princeton Seminary and one of the country's leading theologians.

'If it is a choice,' he told me, 'between the uncouth life of the Pentecostals and the aesthetic death of the older Churches, I for one choose uncouth life.'

"But what if there need not be this choice? What if there can be a synthesis on a higher plane than either, so that in our Churches we have form and life growing Godward together? What if Pentecost comes to the Church today?"

If you are utilizing the precious, God-given gift of the powerful questioning Mind to seek *Absolute Truth*, then I need say no more. However, if you are not and will not pursue such *Truth* with your Mind, then it would be a mutual waste of time for me to say more to you on this subject.

I do, however, perceive the following Truth from God: People of every religious denomination/persuasion throughout the world who worship/pray to God or to God's Essence should respect one another, love one another, care for one another, and, as a Unity of One, pray to God for one another.

Throughout the world, God-loving individuals who fight amongst themselves only serve to provide evidence to non-believers that God does not exist. Peace between such individuals should provide evidence to the non-believers that God is real.

Many non-believers ask by what means does God simultaneously talk with or influence millions of people throughout the world? Scientifically speaking, I can visualize that such is accomplished in a manner similar to a powerful radio or TV transmitter. Only if one is attuned to "God's Channel" will one receive God's message.

Even with a normal TV or radio one can only receive

a broadcast if one is properly tuned to that frequency. Of course, it is technologically possible for millions of individuals to do so simultaneously.

When one prays and is tuned into "God's Channel," then one is transmitting a message. However, one only reaches "God's Channel" by being sincere. One could consider "God's Channel" to be a "pay-TV Channel" in the sense that the "payment" God expects is the sincere and consistent utilization of your honest and questioning Mind.

It is a recognized fact that one's brain operates as both a transmitter and a receiver of electromagnetic waves. It is also known that the electromagnetic wave pattern will vary according to one's thoughts. When an assembly of individuals (as in a Church) began in unison to pray and "transmit" on the same "channel," such activity acts as a powerful transmitter to and receiver from God.

I have no doubt that our scientific capability appears less than barbaric by comparison to God's scientific capability!

We are all composed of the same type of gyroscopic particles that exist throughout the Universe. Such particles can certainly be mechanically foreseen and understood by God.

Based on the concepts I have expressed in this Book, the time is long overdue for wise men and women and heads of religions and nations to join together to produce a Doctrine capable of providing the people of the world with enduring Peace, Love, and Happiness.

By the grace of God, I have developed an innovation capable of uniting the world mechanically and technologically. But without the proper conceptual teachings, such an innovation means nothing. God has provided us with "Free Will" and a powerful questioning brain. If we utilize such a brain properly, we can achieve the goal of pleasing God and ourselves.

There are those who will read what I have written on the "subject of God" and be convinced of its Truth. I fully realize that there will be those who will be skeptical, unconvinced, or only convinced that I am a "religious nut." Some will perhaps be of the "charitable" opinion that I am a *sincere* "religious nut." I am well aware of the possibility of such reactions.

I stress to the reader, however, that I am not writing this Book *only* for present audiences, but rather for those who will be our distant descendants. Consider the many occasions in history when someone was branded a "nut" by his contemporaries, only to be proven correct and insightful in later times.

My purpose in presenting the "speaking in unknown tongues (languages)" subject within the context of a scientific treatise is to encourage the sincere and scientific investigation of this phenomena. Only by the honest inquiry of our minds will we ever be capable of unlocking the seeming secrets of the Universe.

With such an open, questioning, and truthful mind, I wish to discuss another subject of vital importance to this worthy goal: ECONOMICS.

Chapter 23

THE MERGER BETWEEN MECHANIZATION AND ECONOMICS

"It is one of the most beautiful compensations of this life, that no man can sincerely try to help another without helping himself."

— Shakespeare

Economics is a subject that strongly demonstrates the "unjust" and "detrimental" results of the *brainsoiling** effect generated by our present primitive teaching system.

I majored in Accounting and Economics in the traditional college and quit college during my Junior year.

As an adult, Economics is one of the first subjects whose validity I strongly challenged. Even as a young man, an honest and caring concern for humanity ran deep within my being. I was deeply touched by the subject of Economics because I knew that it affected the physical well-being of the total population upon this planet.

Originally, it required considerable thought to properly analyze the incorrect scientific thinking which I have discussed in this Book. However, when I proceeded to study Economics, I was *shocked* by "accepted teachings" which my thinking, caring, and questioning mind recognized as being obviously **wrong**.

After studying in traditional economics, I found that my questioning mind — which has always pursued *Absolute Truth* — would not be stilled. I loudly spoke up in my Economics class and said: "What is being taught is wrong!" At first my teacher thought that I was a smart aleck and told me that if I was so smart I should "get up and teach the class." I responded by proceeding to do just that.

As a result of my delivery to that Economics class, I successfully stimulated the thinking processes of every young man and woman in the room. My delivery prompted my fellow students to eagerly begin to think and question.

At this point, I wish to pay tribute to my exceptional Economics teacher — Mr. Paul R. Cooper — who was not offended by my response to his challenge of me and from that point continued to encourage my questions. I immediately sensed that Mr. Cooper was an exceptional teacher. Prior to that time, I would ask questions and would always be told by my teachers: "Joe, you are holding up the class." I do not even recall the names of such teachers.

In 1961, I wrote to President John Kennedy because I

was very concerned about Economic teachings which failed to offer a sound solution to the obviously severe problems repeatedly observed in Economics. One of President Kennedy's special assistants (whose name I have unfortunately forgotten) responded by mail by sending me a copy of President Kennedy's Congressional recommendation entitled: *How to Add Momentum Back to the American Economy*.

I handed the copy of these recommendations to Mr. Cooper, whom I respect as a teacher and human being. Mr. Cooper was very pleased, made copies of the recommendation, and distributed them to the students in all of his classes.

At the end of the semester, Mr. Cooper took me aside and said: "Joe, I wish to thank you."

"What for, Mr. Cooper?" I replied.

Mr. Cooper responded, "Joe, I am an old man, and Economics is one of the most important courses a student can take since it affects one's whole life. Over the years, however, students attend my classes and behave dryly and unresponsively. You have generated more enthusiasm and participation from this year's class of students than all of my prior years of teaching achieved. I simply wanted to thank you, Joe."

I warmly replied, "Mr. Cooper, it was my pleasure to be your student and attend your class." I often think of Mr. Cooper with great warmth even though I have not seen him since I left college as a young man. *Mr. Cooper was truly a teacher!* I sincerely recommend that any teacher who wishes to be warmly remembered by her/his students should so conduct herself/himself. By such actions, the teacher will do her/his students and herself/himself honor, justice, and stimulate progress.

I humbly pray that I can use my talents to stimulate you and the world to *question, think, and become excited* about Economics and the future of our world. Read again in Chapter 20 my 1967 letter to President Johnson in which I predicted "An Energy Innovation and a Merger between Mechanization and Economics."

Just as I was "shocked" as a young man, I will now attempt to "shock" you. There is an old saying — "A picture is worth a thousand words." The following graph is far more valuable than a *million* words:

*It is more semantically precise and descriptive to use the term *brainsoiling* rather than *brainwashing*, since "washing" implies a purification process; "soiling" implies just the opposite. This semantic distinction was first developed and employed for such usage by Evan R. Soule, Jr. in 1981.

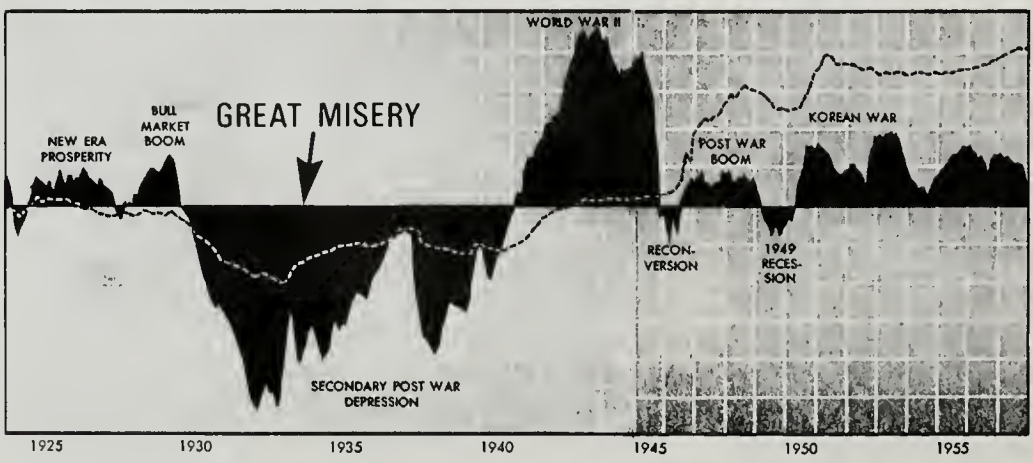
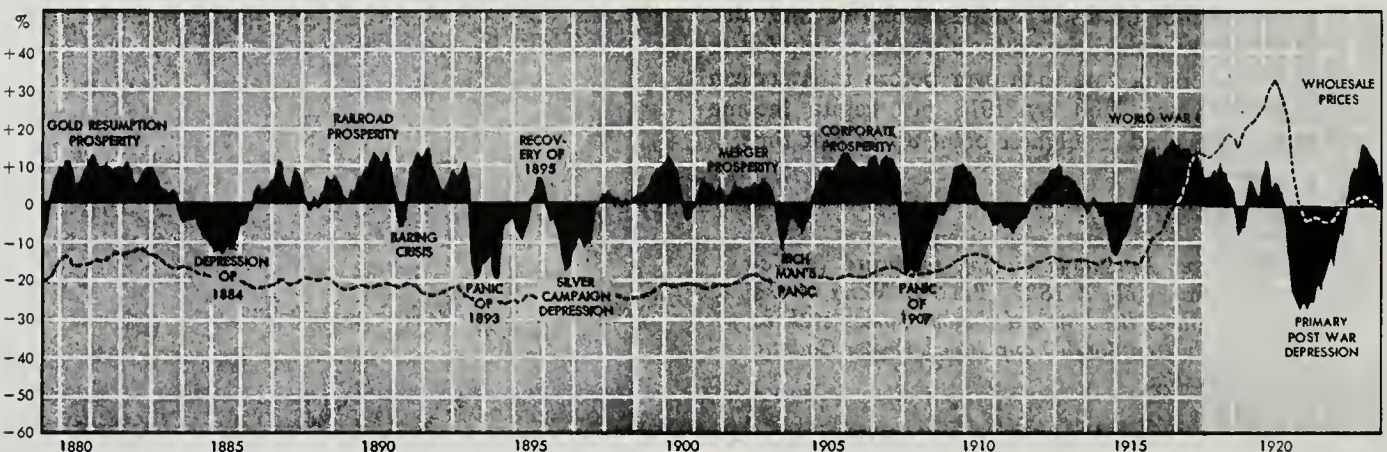
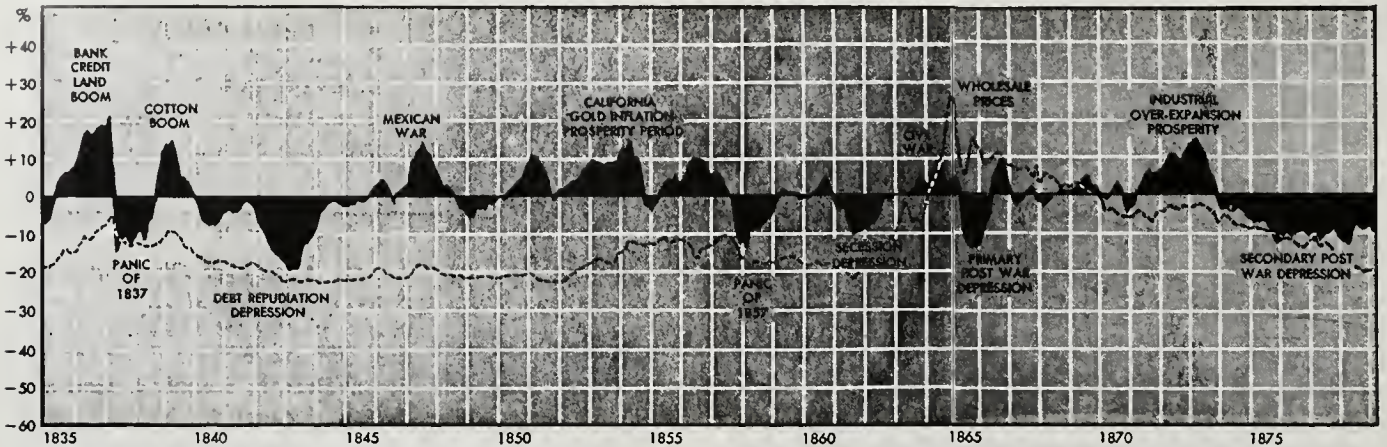
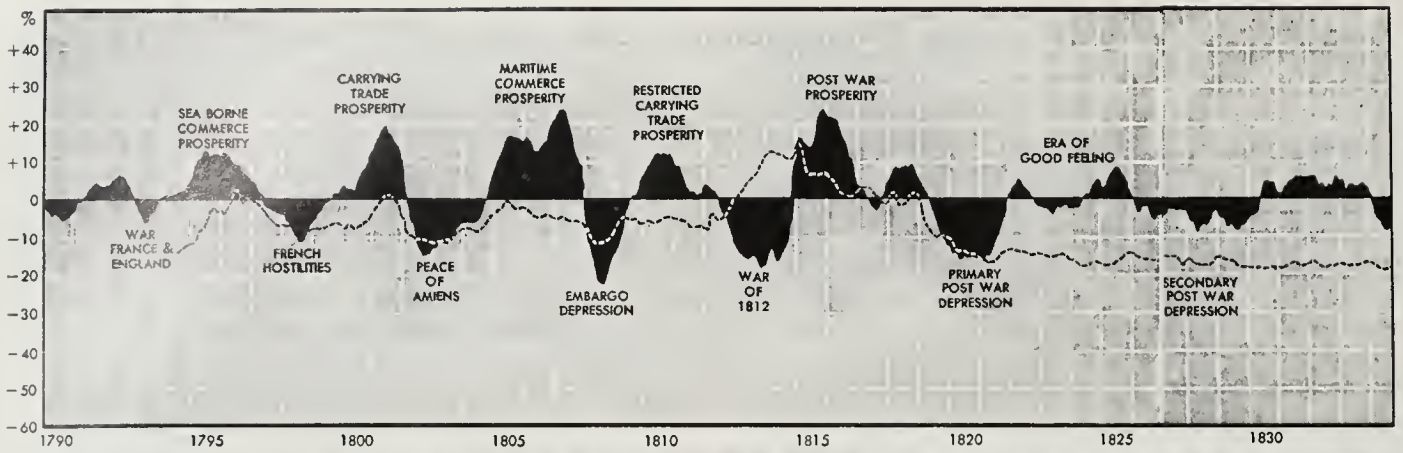

American business activity, shown in solid black and indicated by the scale at the left, has been subject to wide fluctuations from the long-term trend. Changes in wholesale commodity prices are suggested by the dashed line.

Reprinted from "An Economic History of the United States" by Gilbert C. Fite and Jim E. Reese, Boston, Houghton Mifflin Co., 1959.

This graph is from my basic economics text entitled "An Economic History of the United States."

Imagine taking such a graph to a given company's competent production engineer anywhere in the world and informing that individual that: "I have a new production machine for your assembly line. This graph I'm showing you demonstrates my new production machine's operability and dependability — it works for a week, breaks down, works for a week, breaks down, etc." It should be obvious that the company's production engineer would tell such a person to "get lost."

But how ironic it is that the same graph which depicts societal inefficiency does affect and control the entire above-discussed company as well as its assembly lines. This fact was clearly demonstrated in the early 1980 "Depression" which was euphemistically called a "Recession." There were many long-time, established companies which permanently closed their doors during this recent Depression. It was a heartbreaking experience to watch the dependable employees of such companies lose their jobs and the sincere managements be helpless to prevent such loss and closure. Company management believed they neither created nor knew how to fight the "unseen enemy" of an economic Depression.

Are you "shocked" by these economic events? I was and I remain shocked to this day! I simply could not believe that I lived in a world that would blindly repeat the same mistakes — so costly and damaging to human life and happiness — over and over again. What I have witnessed is an extremely inefficient economic mechanism that first "soothes," then "worries," and then "slaps down" human beings. The trickery and deception which creates such human misery apparently goes unnoticed by others.

Since the late 18th century, periods of prosperity and depression have succeeded one another at irregular intervals in the United States, Great Britain, and other industrial nations throughout the world.

It is currently taught that the essence of economics is "supply and demand." This teaching is *totally false*. As it now exists and has existed in the past, the essence of economics is "Fear" and "Greed."

I urge the reader not to blindly accept what I teach. On the contrary, you should *honestly question* both what I teach and what you have learned from the past.

Simply examine the graph depicted above and prove to yourself that "Fear" and "Greed" are the true economic culprits of our present civilization. On the graph, all nodes located above the zero line represent inflationary action. Inflation occurs because of "Greed." This problem will only be solved if *Absolute Truth* is consistently taught to the entire world.

At the height of an inflationary cycle (the highest point on the nodes above the zero line), the "Greed" Factor becomes so outrageous that consumers begin to refuse to purchase commodities or services. Even though the consumer still desires goods/services, the consumer refuses to purchase and endeavors to wait for "fair" and

"reasonable" prices. At this point in time, manufacturers have extensive inventories as a result of having recently increased their production capacity.

Such facts clearly prove that the essence of economics is not "supply and demand." Actually, at the point of maximum inflation, there is an abundant "supply" of inventory and a strong consumer "demand" for such goods/services. The problem is that the consumer simply refuses to purchase the goods/services at prices which are "unreasonable" and which represent "Greed."

Such "Greed" results in unemployment at the companies who supply raw materials and the factories who manufacture the products. At this stage, the psychological factor of "Fear" becomes manifest. Such "Fear" precipitates a sharp decline towards a "Depression." On the graph above, such Depressions repeatedly follow the inflationary cycles. [They begin at the point immediately following the height of the inflationary cycle and fall to the lowest point on the node below the zero line.]

It is ironic that the initial extensive unemployment occurring at the height of the Inflation ("Greed"), initiates a negative chain reaction by instilling a "Fear" factor which results in a Depression.

Such "Fear" causes consumers not to purchase goods/services even when prices are lowered during a depressionary cycle. When goods and services go unsold, unemployment increases. Everyone is well acquainted with the extensive human misery that occurs during a Depression ("Fear").

I repeat that the essence of "present" Economics is *not* "Supply and Demand." *The essence of "present" Economics is "Fear" and "Greed."* I am certain that the reader recognizes that "Fear" and "Greed" do not represent the essence of Science or of a "thinking, questioning, and truth-seeking mind." "Fear" and "Greed" are totally inappropriate as the controlling factors for the essence of the "economic well-being" of human beings.

"Present" economics is indeed "a subject that strongly demonstrates the 'unjust' and 'detrimental' results of the brainsoiling effect generated by our present primitive teaching system.

I implore you not to close your mind. To do this would only endorse a continuation of human misery.

The facts demonstrated by the above Graph prove that I speak the Truth. Such facts clearly prove that "present" economic dislocations result from the repetitive cycles of hope (Greed) and misery (Fear). This economic system is highly inefficient and demonstrates an unwillingness to sincerely *question* the observed problems and seek *Absolute Truth* with respect to a realistic solution.

I now wish to focus on the presentation of a "Positive" solution rather than discuss the "Negative" nature of the problem. I seek to inspire and excite you as to the solution for our economic problems. Such a solution will replace the "Old" with the "New" and will be extremely efficient. This solution will offer the human population of our planet a continuous enjoyment of *physical well-being* rather than intersperse such enjoyment with

“Greed,” “Fear,” and “Misery.”

Let me share with you how I perceive the *Absolute Truth* for the essence of Economics:

“Economics is simply a ‘thought tool’ with respect to the efficient utilization of human power via mechanical devices!”

We cannot and should not lose sight of this Fact! To do so only “mocks” the very essence of the deep motivating force within the truly creative individual.

“Economics is simply a ‘thought tool’ with respect to the efficient utilization of human power via mechanical devices!”

While he was President of the National Academy of Science, Frederick Seitz eloquently stated it this way:

“Regardless of the diversity of nationalities, personalities, and specialties, scientists everywhere — intentionally or not — are bound together by a common purpose: the advancement of human capabilities.”

I might add that this fact is true for any *creative* individual. I have classified a *Scientist* as anyone who honestly questions what they are taught and then sincerely and diligently seeks a correct answer to their original question(s). Furthermore, they then seek to improve upon what they have been taught.

Such an attitude is exemplified by the Pioneering Electromagnetic Energy Invention which I have innovated during twenty years of dedicated effort.

EXAMPLE: Several years from now, imagine that my innovation is in full production for any type of device necessary to perform a given task.

At this point — according to the old (and incorrect) economic teachings — the management of all manufacturing/production companies will decide to mechanize and replace *all* human operations with robotics. The management will conclude that by firing most of their employees they can increase profits for their company. Such “Greed” — or lack of concern for human welfare — will engulf companies throughout the world as they endorse the same selfish idea.

I agree that any routine task performed by a human being can be more efficiently accomplished by a mechanized device. *However, the results obtained via “Greed” or such a selfish and “unthinking” response on the part of a company will be opposite to management’s expectations!* If all companies fire most of their workers, this would not only drastically reduce the work force but would also drastically reduce the purchasing power of the consumer — a consumer readily *desired and needed* by all companies to provide an outlet for manufactured products. The economic result of such diminished purchasing power is a “Depression!” Products and services would simply go unsold because

the “unemployed” consumer would lack the available financial resources.

It should be obvious that *both* the potential consumers (who are generally employees) and company management do not desire the negative results of a “Depression.”

I sincerely urge both “Labor” and “Management” to question, think and seek *Absolute Truth* — only then will both sides recognize that the facts of economics with respect to an Efficient Economic Program prove that “Labor” and “Management” are *not* enemies. On the contrary: *Neither can exist without the other! For one side to truly function efficiently, so must the other.*

It is therefore only pure economic sense for each side to be concerned about the prosperity of the other side. The facts clearly demonstrate that as one side efficiently functions, so does the other.

As a scientist who always searches for *Absolute Truth*, I find this “Fact” of efficient economics very pleasing. *This fact proves that in order to achieve an Efficient Economic Program, we must care for one another’s economic well-being.* Such a true concern for one another contributes toward national and “world peace.” Once again, I recognize the same common denominator I had discussed in my earlier chapter on God: *Goodness!*

I now wish to specifically present the *positive* perspective: permit me to excite, stimulate, and “open your mind” to the magnificence of the future which can begin with *positive, thinking action.*

I ask that company-management/owners consider the following *positive* economic results of my invention rather than the above-described *negative* economic results:

Consider what would occur if all companies, instead of firing workers as mechanization proceeds, simply have such employees *work less hours* for the *same* salary.

Your first unthinking reaction to such a proposal would be to say “Such a proposal is ridiculous!” My response: NOT SO! Examine the *whole* picture and not simply a *microscopic portion* of the whole picture.

If the workers utilize the benefits of Mechanized Pro-

“Examine the whole picture and not simply a microscopic portion of the whole picture.”

duction, then such workers can produce more products in less time and at less cost.

Now you, the “worker/employee”, must also *think.* You must not continually strive to raise your salary. Your first unthinking reaction to such a proposal would be to say, “Such a proposal is ridiculous!” My response: NOT SO! Examine the *whole* picture and not simply a *microscopic portion* of the whole picture.

If all workers produce more products at reduced costs, then the consumer — you — will have more products available at reduced cost. In effect, this decreased product cost to the consumer represents a *continuous salary increase* without the “negative” results affecting

the *whole* picture. The positive actions I propose will naturally decrease costs and dramatically increase the well-being of all people.

And from the management/employer perspective: If worker employment is high, then there is an extremely large consumer population willing and desirous of purchasing your products.

Moreover, as the working hours of the "employee/ workers" decrease, then these employee/workers have more leisure time available. Such leisure time generates additional demand for more products, services, new companies, and greater employment.

Sound and "thinking" Economics requires that realistic safeguards proposed by the general public, company managers, and employees be established. If properly prevented, "Greed" and "Fear" will not occur. *At the same time, however, incentive must not only be maintained but stimulated!* It is an observational fact that animals perform far more efficiently when an incentive reward is provided for their efforts. For human beings, this is even more true.

Companies must strive to increase financial profit via increased production and sales, *not* by price increases.

Similarly, workers must strive to obtain more products and services *not* by salary increases but via increased production which *lowers* the cost of such products and services.

If a company enjoys an increased demand for its products or services, that company must *not* proceed to irresponsibly raise its prices, if at all.

In essence, top-level company management, top-level employee personnel, politicians, other responsible individuals, and especially *you* — the "voters" — must unite to think, question, and solve problems *together*. If such is done, then the Positive and Efficient Economic program I have described *will occur*.

The following statement is a *Fact*: *If "Fear" and "Greed" are replaced with "Truthful Thinking," Questioning, and Action, then the realistic results of the Economics which I teach will produce the following graph:*

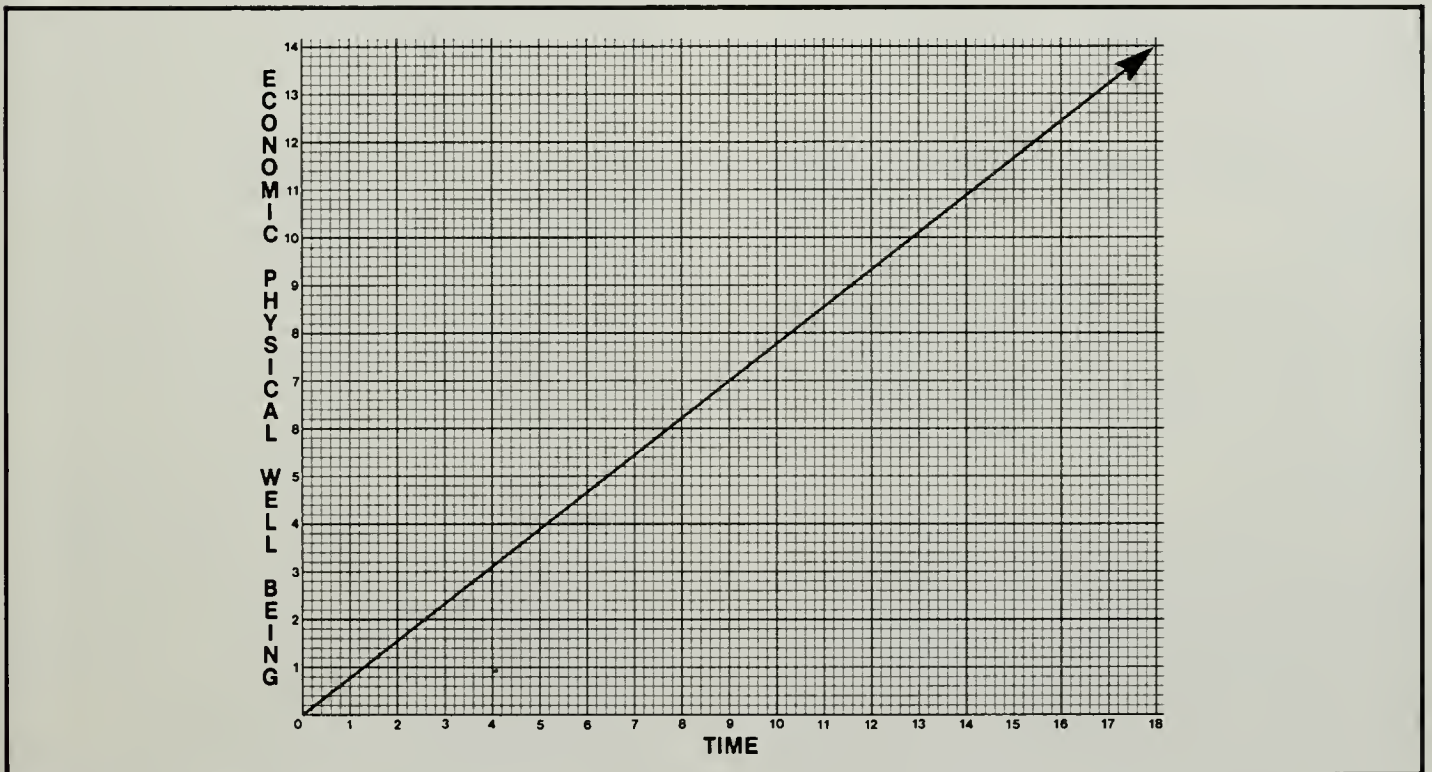

What I have been discussing is Positive Economic Action that is compatible with the Revolutionary Energy Invention to which I have devoted many years of my life. Such Positive Economic Action will enable Space Travel to become an efficient and exciting reality. I am also speaking of the beginning of positive hopes and dreams for our young children and those future generations who look to us for a "smoother road through life!" The historical facts prove that in Economics we most definitely "reap what we sow."

That which is required is actually quite simple. What is required is that we *truthfully* "Question, Think and Act." The achievement of what I have described also requires *that we care for one another* which is the functional essence of *Goodness*. Moreover, the simplicity of what is required is mirrored in the "twinkling eyes" of our ever-questioning children. Such simplicity only demands that we creatively utilize the "Birthright" of our own "Questioning Mind," which has previously remained as a *Sleeping, Majestic Lion*.

I urge this "Majestic Lion" to *awaken! And the world will be changed most beneficially.*

The following Chapter will discuss an area requiring urgent attention and constructive change for the benefit of you, the "People."

Chapter 24

THE PATENT SYSTEM

"Justice delayed, is justice denied."

— William E. Gladstone

The sole purpose of *any* Patent Office throughout the world is to stimulate the creativity of the people in all countries. Such action generates benefits for all inhabitants of the planet.

This discussion of the patent system will begin with a quote from an article in *U.S. News and World Report*, 1981, February 2, pages 45 and 461, entitled "Patent System ... A Drag on Innovation." The article quotes Donald W. Banner, former Commissioner of the U.S. Patent and Trademark Office, who says:

"A U.S. Patent has become a cruel hoax, providing neither protection nor incentive for development of inventions."

When inventors and their inventions suffer at the hands of Patent Office Officials, then the people of all nations suffer. This is so because such inventions which could bring to all people prosperity and happiness are stifled, restricted, suppressed, and/or interminably delayed to the point of extinguishing creativity and hope.

The *total injustice* which I have been forced to endure for years from the U.S. Patent and Trademark Office with respect to my Pioneering Energy Invention clearly illustrates and confirms the truth of the above quotation by Donald W. Banner. Due to lack of space, I will not present all the shocking details of the very extensive file (over 1500 pages) concerning the *injustice* inflicted upon me by the U.S. Patent and Trademark Office. I will, however, quote several sections from the public records of the Washington, D.C. Federal District Court Case No. 83-0001 concerning my lawsuit against the U.S. Patent and Trademark Office.

For years, I have carefully and *factually* documented my file with respect to both the actions of the U.S. Patent Office and the Federal District Court. Such extensive documentation is being accumulated because I do not want other creative and talented individuals to be exposed to *Injustice* from employees of the U.S. Patent Office.

As of the time of this writing, the following is a *brief* outline of what has occurred:

1. My Constitutional Rights were and are being deliberately violated.

A. I was originally told in January 1982 by Patent Examiner *Donovan F. Duggan* that he didn't think he would ever be able to give me a Patent "no matter what evidence I presented to him."

[On September 12, 1983, a Federal District Court in Texas found that Donovan F. Duggan's "Knowledge of electrical theory may have been inadequate for his responsibilities." (See *Lindsey v. United States*, Civ. Action Nos. TX-79-60-CA, TX-81-39-CA.) This Texas case involved the same Examiner Duggan and another inventor, Ralph Lindsey. The Federal District Court in Texas also found that Examiner Duggan rejected the patent application of Ralph Lindsey because he (Duggan) "misunderstood" the nature of the device and therefore "carelessly and incorrectly perceived" it to be a "perpetual motion machine." The Court found that Duggan summarily rejected the Lindsey application with a "cryptic comment" failing to provide "such clear and full disclosure of reasons for rejection as required by the regulations." The Court found that once Duggan was "convinced" it was "a perpetual motion machine," he "seemed unable to consider the design on its own merits." The Texas Court concluded that, as a result of Duggan's negligence, Lindsey failed to receive a patent that was later issued instead to a Mr. Davis for a similar device.]

B. My legal rights to a Pioneering Patent have been unscrupulously delayed for over five years.

2. There has been and still is a deliberate violation of U.S. Patent Law.

A. I was informed by a U.S. Patent Office Examiner that he had not read my extensive, 133-page Disclosure Document.

B. The Patent Examiner refused to clearly define his objection to my Disclosure Document.

C. The Patent Examiner refuses to accept the Affidavits attesting to my energy machine's operability. These Affidavits have been provided by more than thirty independent, competent, scientifically-educated individuals who include nuclear physicists, electrical engineers, electrical technicians, etc.

3. The U.S. Patent Office has consistently, deliberately, and with premeditation misrepresented and distorted the *Facts*.

A. Patent Office employees have falsely stated that I claim my energy machine is a "perpetual motion device."

B. The Patent Office employees have implied that I had a "hidden energy source." (Several other Patent Office employees later agreed that this was not the case.)

C. The Patent Office employees doubted that my 5,000-lb. operational prototype even existed.

D. The legal counsel for the Patent Office had a "witness" (who had never actually tested my energy machine) sign an Affidavit questioning the operability of my energy machine *despite the fact* that *at the time* the "witness" truly believed the possibility that the

"The U.S. Patent Office has consistently, deliberately, and with premeditation misrepresented and distorted the Facts."

energy machine worked. Later, this same "witness" *reversed himself* and submitted a second Affidavit which attested to the operability of my energy machine.

E. The Patent Office made false statements to the effect that all of the independent scientists who had endorsed the operability of my invention had an interest in my invention.

F. There are many other distortions too numerous to list in this Book. Such distortions are contained in the entire Court records and available documentation.

4. The U.S. Patent Office has consistently acted as a "hostile adversary" towards the development of my Pioneering Energy Invention.

A. A representative of the Patent Office who acted solely as an adversary came to my house to question testimony submitted by two competent scientists — testimony which was provided in Depositions verifying the operability of my Pioneering Invention. At the same

"The U.S. Patent Office has consistently acted as a 'hostile adversary' towards the development of my Pioneering Energy Invention."

visit, however, the Patent Office *refused* to furnish anyone to physically test my energy machine despite the fact that my attorney had repeatedly asked that such testing be arranged before the Patent Office representative traveled by plane from Washington, D.C., flew to New Orleans, and rented an automobile for an approximately 130-mile drive to my home in Lucedale, Mississippi. *After* the patent office representative arrived at my home, he informed me that he was unable to conduct testing on my energy machine since

he was not technically qualified. MY QUESTION: If such an individual admitted that he was technically unqualified, then how could he be qualified to judge the capability of the technically qualified individuals who *had* tested the energy machine?

B. The Patent Office falsely implied that I and the more than thirty scientifically-educated individuals who had attested in Affidavits to the validity of my Pioneering Invention were all incompetent.

C. Major William Schuyler, Jr., a former Commissioner of the U.S. Patent Office, was *nominated by the Patent Office* and appointed by the Federal District Court to evaluate the validity of my energy machine. Both the Patent Office and the Federal Judge expressed the fact that they were very impressed with Mr. Schuyler's superb technical qualifications. (See a further discussion of this subject in the following Chapter.)

After evaluating my energy machine, Mr. Schuyler wrote in his *Report of the Special Master*, dated September 28, 1984:

- (1) "EVIDENCE BEFORE THE PATENT AND TRADEMARK OFFICE AND THIS COURT **IS OVERWHELMING** THAT NEWMAN HAS BUILT AND TESTED A PROTOTYPE OF HIS INVENTION IN WHICH THE OUTPUT ENERGY EXCEEDS THE EXTERNAL INPUT ENERGY: THERE IS **NO** CONTRADICTIONARY FACTUAL EVIDENCE." (Emphasis added.)
- (2) The Patent Office has presented "no contradictory factual evidence."
- (3) There was ample evidence that one skilled in the art could construct or utilize the energy machine.
- (4) The Patent Office did not examine the petitioner's (Mr. Newman's) application "on its merits in accordance with usual practices."
- (5) The Patent Office Board of Appeals' finding rejecting such a machine as "impossible" was "clearly erroneous."
- (6) Petitioner Newman "is entitled to a patent."

The legal counsel for the Patent Office had originally vouched for the superb credentials of former Commissioner Schuyler at the time Mr. Schuyler was nominated for Special Master to the Federal Court. After the *Report of the Special Master* was issued, the same legal counsel vilified former Commissioner Schuyler and advised the Court to "exercise some common sense and refrain from joining those who apparently still believe in the tooth fairy." The legal counsel was, however, incapable of specifically advising the Court as to why the findings of the former Patent Office Commissioner were incorrect.

D. All of the above, I through 3F.

5. As a result of the *Injustices* described above (and *many* others not included in this brief synopsis), I have been forced to write this Book and fully disclose the nature of my Pioneering Invention without the full benefit of Pioneering Patent protection to which I am entitled by law.

6. The Injustices inflicted upon me by the U.S. Patent Office have cost me (as of this date) over \$200,000.00 in legal expenses and, more importantly, have cost the American people and the World the opportunity to enjoy the benefits of a revolutionary energy invention.

I must stress to the reader that such Injustices go far beyond myself. If these Injustices are permitted to continue without reprisal, then you may be assured that *other* creative individuals *will continue* to suffer such injustices — injustices which will *only increase* with time.

I do not so vigorously fight this battle with the Patent Office solely for my own benefit. *I especially fight for those creative individuals whose sensitive dispositions can be shattered by such injustice!*

I ask the reader to use your “Questioning Mind” and examine the many existing innovations which eliminate

“I especially fight for those creative individuals whose sensitive dispositions can be shattered by such injustice!”

the drudgery from your life. What is the *source* of all these beneficial inventions?

ANSWER: Such beneficial inventions were innovated by *creative individuals* at a moment in time when such individuals envisioned something “new” that had not been previously understood. These beneficial inventions were *not* created by Kings, Queens, Presidents, politicians, etc., but were developed by *creative individuals*.

Simply examine the previous several thousand years of human history and ask, “Why have there been so many significant material improvements?” The facts prove that: **the Jewels of our civilization are our Creative Individuals!**

Is it not logical that we should at least protect, nurture, and inspire our Creative Individuals with the same diligence and protection provided in Nature by a productive “worker bee” to a “Queen bee” within the hive?

The Constitution of the United States directs that we behave in such a fashion. Moreover, the sole purpose of the U.S. Patent Office is to afford such protection.

The facts prove, however, that the Patent Office is failing to do its job. It is obvious that proper legal actions must be initiated to guarantee that the Patent Office properly performs its very important function.

I urge the reader to contact your elected officials and demand that your “Queen bee” — the Creative Individual (by which you and your future descendants will continuously benefit) — be *protected* such that *creativity* is *stimulated* and not stifled.

At this point, I wish to pay tribute to the News Media. *In many instances, the News Media are the “lubricant” which “unclogs” the wheels of our Democracy!*

I urge the News Media to vigorously investigate the Facts concerning the behavior of the U.S. Patent Office and to maintain such an investigation until the U.S.

Patent Office is operating efficiently and legally. From this point forward, the People and the News Media should closely and continually monitor the performance of the U.S. Patent Office. If warranted, the public should be advised by the News Media when action is necessary. Such action should then be taken immediately to prevent further stifling by the Patent Office of individual initiative and creativity.

While most members of the News Media have fairly and accurately reported my case to the public, there have been several news stories that did a disservice to the news reporting profession. In each case, these factually inaccurate news stories were written anonymously. It requires no personal courage to attack the potential rightness of an individual from a protective cloak of anonymity. Being unwilling to assume explicit credit and reputational risk for what was written is a form of cowardice.

One of these inaccurate, misleading, and anonymous articles appeared in DISCOVER magazine. This reputed scientific magazine hired the services of a magician in an attempt to discredit what I have accomplished. If a hoax was really feared, then a more scientific approach would have been to send someone having technical and scientific credentials to accompany the magician in the event my work appeared to indeed be genuine. This was not to be, however. By indicating that he was an “investigative consultant,” the magician did not truthfully represent himself to me on the telephone, and implied that he possessed the requisite scientific credentials. Also, the “investigative consultant” promised to confer with me following his investigations and before he submitted his findings to the magazine. This he failed to do.

The article that finally appeared in DISCOVER magazine was replete with factual inaccuracies. However, since the “investigative consultant” is a professional magician, I would say that he is eminently qualified to investigate the illusions which appear to exist within the mind of the individual who fabricated the article in DISCOVER magazine.

A second inaccurate, misleading, and anonymous article appeared in the *New York Times* entitled “Perpetual Invention.” In this article, the writer describes my energy machine as a “perpetual motion machine.” I have repeatedly stated that my machine is *not* a “perpetual motion machine.” Such an unscientific attitude on the part of the writer indicates an unwillingness to examine an innovation which requires new thought processes. Labeling an invention a “perpetual motion machine” relieves the writer of the responsibility of seriously and scientifically considering my theories and innovations.

The *New York Times* anonymous writer specifically wrote: “Mr. Newman calls his device an ‘energy generation system having higher energy output than input — an electric motor that gets something for nothing.’ This statement is **totally false!**”

I have very specifically described my energy machine as a device generating “greater *external* energy output than *external* energy input.” This statement is totally

different from an electric motor that "gets something for nothing." The depth and validity of my work has already been sincerely presented to you, the reader. The irresponsible action of those individuals who make such unthinking statements is exposed for what it is.

In general, however, the News Media has acted responsibly, accurately and fairly. Their actions can continue to serve the public in a beneficial manner by alerting them to the unjust actions of the U.S. Patent Office.

I have included a copy of an Affidavit concerning the U.S. Patent Office which I presented to the Federal District Court in Washington, D.C. This Affidavit recommends specific changes in the patent system which I had originally suggested to Mr. Paul Gomory, expert advisor to the Senate Judiciary Committee on Patent Office Affairs.

AFFIDAVIT OF JOSEPH WESTLEY NEWMAN

For the benefit of the Honorable Court, I submit the following Exhibits A, B, and C and related following comments.

In July, 1982, as a result of my grievances given to Senator Stennis' Office concerning this patent application and its resulting treatment by the U.S. Patent Office, I was given a meeting with Mr. Ralph Oman at his office. Mr. Oman is Staff Director of Criminal Law Subcommittee, Committee On The Judiciary, United States Senate.

After discussing my concern with Mr. Oman for a short period of time, Mr. Oman stated he wished me to talk with and explain myself to Mr. Paul L. Gomory, whom he advised me was an Expert Advisor to the Judiciary Committee on Patent Matters. Thereupon, Mr. Oman called Mr. Gomory by phone and I talked with Mr. Gomory for a while and then met with him personally the next morning for about one hour.

I returned home that day and within the week wrote Mr. Gomory a five page letter explaining my concerns, which is attached as Exhibit C, and also forwarded a copy to Mr. Oman, which is attached as Exhibit B.

Said five page letter prompted Mr. Gomory in writing a most positive letter in my behalf to Mr. Oman and is attached as Exhibit A. (Information concerning Mr. Gomory is attached as Exhibit A1.) Especially see the first one and one-half sentences of paragraph 4 of first page. Quote: "I feel strongly, very strongly, the situation that Joe is experiencing.

Manifestly, this is not the way to treat our inventors, much less their inventions....." Unquote: (Emphasis Added)

Also see last paragraph of page one. Quote:

"I subscribe to Joe's letter in general. I have experienced his experiences, especially as related in each of the paragraphs, especially beginning with paragraph 4 and 5 on page 2 to the end of his letter including his excellent suggestions which take into consideration the nature of the human being." Unquote.

I have not received or been told any information by these individuals which have stated or implied contradiction to the above facts.

Leaving one to conclude others of prominate, pertinent position feel my complaints are justified.

The undersigned declares further that all statements made herein of the undersigned's own knowledge are true and that all statements made on information and belief are believed to be true; and, further that these statements were made with the knowledge that willful false statements and the like so made are punishable by fine or imprisonment, or both, under Section 1001 Title 18 of the United States Code and that such willful false statements may jeopardize the validity of the application or document or any registration issued thereon.

DATE: 16 Aug. 1984 Joseph Westley Newman
JOSEPH WESTLEY NEWMAN
STATE OF MISSISSIPPI

County of George
Sworn to and subscribed before me, this the
16th day of Aug., 1984
Garry Ray Harvey, Chancery Clerk
By Conna Lon Holland, D.C.

My Commission Expires 1st Monday in 1988

copy

August 2, 1982

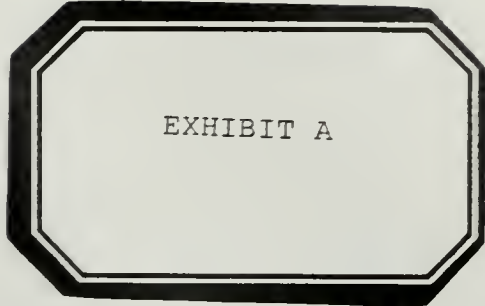

EXHIBIT A

Ralph Cran,
Chief Legislative Assistant
Senator Joe Mathias

Dear Ralph:

Enclosed is a copy of a letter mailed to Laurence Pretty, Chairman, ABA, PTC Section, Committee on Patent Law Revision. Copies were made on Saturday and mailed on Sunday. This is the first opportunity I have to write to you concerning our discussion on what should be done, as discussed with you on the phone when, responsive to your request that I do so, I outlined to you briefly my then thoughts on how to break the many impasses which I have encountered in my practice and which, unfortunately, Joe Newman has encountered. My letter to Larry Pretty amplifies somewhat my thoughts in the matter. When I have heard from the Committee and others to whom I have sent copies of the letter now enclosed, I shall again be in touch with you, ready to draft a proposed bill if this seems indicated at the time.

The persons receiving copies of the enclosed letter are all of them well-respected leaders and/or officers in the associations to which I belong.

Just this morning I have Joe's letter of July 30. He indicates thereon that you have received a copy. My comments on Joe's letter can be brief because you should already have it.

I feel strongly, very strongly, the situation that Joe is experiencing. Manifestly, this is not the way to treat our inventors, much less their inventions which they should be encouraged to disclose responsive to the incentive of the system which you know I have frequently referred to as being our VOLUNTARY DISCLOSURE, PATENT INCENTIVE, INVENTION AND INNOVATION SYSTEM. This name for our system, which I have used in testifying before the several houses of Congress, explains or describes that there shall be incentive sufficient to cause "voluntary" disclosure of inventions. Such disclosure immediately permits, when the patent has issued, or earlier when the applicant for patent sees that he has adequate protection in a patent to be issued, that others in the field may begin to build on or attempt to design around the invention, the disclosure having been made responsive to the Constitutional provision of Article I, Section 8, Clause 8. This is indeed ". . . to promote . . . the useful arts . . ."

I subscribe to Joe's letter in general. I have experienced his experiences, especially as related in each of the paragraphs, especially beginning with paragraphs 4 and 5 on page 2 to the end of his letter including his excellent suggestions which take into consideration the nature of the human being.

Ralph Omen

August 2, 1982

I now look forward to the meeting which you have said you would like to have with me and will wait for you to set the date as you have advised me.

Kindest regards,

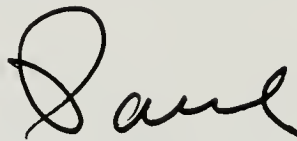
A handwritten signature in cursive script that reads "David". The letters are fluid and connected, with a prominent loop at the start of the "D".

320-4327

cc Joe Newman

Abbreviated Biographical Sketch

PAUL LOUIS GOMORY, born Newark, New Jersey. Lived in several states and traveled in others. Lived ten years abroad during his formative period, attending schools in Hungary, Austria, France and England. Studied chemistry and engineering at the University of London, England and at Polytechnic Institute in New York City. He holds a law degree from Temple University School of Law and is a member of the Bar of the United States Supreme Court, Pennsylvania Supreme Court, the Court of Customs and Patent Appeals, and a number of lower state courts and federal courts.

Paul was an active Washington Athletic Club member for about 23 years. He now works out at The Army & Navy Club, making it to the club regularly. He runs before breakfast. He and Peg are avid bikers. They can be seen on the C & O Canal towpath on Saturdays, Sundays and some holidays.

Paul is Director, Washington Office Phillips Petroleum Company Patent Division. He has served Phillips for over 32 years. Active in politics he is engaged in several endeavors related to the abatement of crime and recidivism. He is personally deeply concerned about federal legislation concerning business, which is America's business.

Bills with which he has been personally concerned are divestiture of organizations in the chemical, the oil, the ferrous, the non-ferrous and other industries. An important item he personally has put in his time on is deregulation, especially of the oil and gas industry which he says ". . . is at the backbone of our great Country's military and economic posture." His concern with patent legislation has been a part of an overall concern for the welfare of our Country.

The recently enacted patent law revision bill is one of several on which he has worked assiduously having testified on it and others on behalf of the Association for the Advancement of Invention and Innovation (A²I²) and on his own behalf. Paul drafted a number of bills which have been introduced in the U.S. Senate as well as in the House of Representatives, and has secured the introduction of the American Patent Law Association bill presented to the 94th Congress. He is an ex-officio member of the National Council of Patent Law Associations.

Paul has chaired a number of committees in the American Bar Association, the District of Columbia Bar Association, and in the American Patent Law Association. These committees have been related to various legislation activities including public relations and public information. He has acted as liaison between the D.C. Bar Association, Patent, Trademark and Copyright Section of the District of Columbia Bar Association and was for many years a member of the Antitrust and Trade Regulation Committee of the Chamber of Commerce of the United States and its Subcommittee on Divestiture which he conceived and formation of which he instigated. He has worked with a large number of other associations including NAM, CMA, PMA, MAPI, ATA, etc.

*Memorandum 1980
of a person - Dec 1, 81*

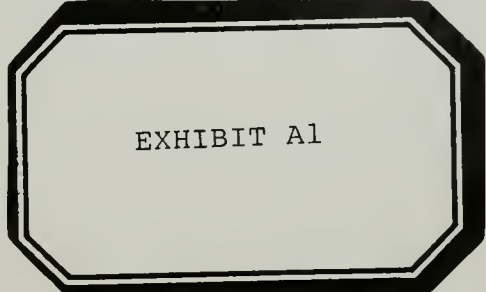

A Director and Advisor of A²I², he has represented the association in legislative matters on the Hill and elsewhere in the private sector and in government. He has prepared and presented testimonies on the Hill where he is well received as shown by the printed records.

Paul has worked with a large number of persons and organizations, personally and informally, on subjects of interest to him. He works in close touch as advisor to Intellectual Property Owners. He worked with the Business Round Table for several years.

Paul has spoken and continues to speak on various subjects including political, legal and technical subjects. He has addressed the Metropolitan Washington Board of Trade, Sertoma, Lions, Oldest Inhabitants of Washington, D.C. Society and other groups including political and civic action organizations. He has been invited speaker to the Practicing Law Institute in New York City and has spoken at a number of technical and legal conferences and conventions.

Paul has authored a number of legal briefs for the United States Supreme Court, as well as articles on political and legal subjects, including Trade Secret Law, Freedom of Information Act, Intellectual Property Law and Government Patent Policy.

Paul is married to Margaret Burke and says that much of what he is and may have accomplished he owes to her aid and encouragement.

The Gomorys' daughter is now Mrs. Nanette Lunde. She and her husband Ivar, who is from Oslo, Norway, teach at the University of Wisconsin, Eau Claire (Fine Arts Center). Paul, Jr. was for several years a Staff Assistant to the President in the White House. During part of this time he was Executive Assistant to Mr. Peter Peterson, later Secretary of Commerce. He is now with Korn-Ferry International, executive management specialists. (Formerly Chairman of the Board of Bell and Howell.)

In his talks to various groups, Paul has sought to impart information leading to a more effective citizenship for those of us who want to do more than simply vote and pay our taxes.

Paul has asked me to state that he appreciates particularly the opportunity which has been afforded to him to appear here today.



RALPH OMAN
STAFF DIRECTOR

CRIMINAL LAW SUBCOMMITTEE
COMMITTEE ON THE JUDICIARY
UNITED STATES SENATE
WASHINGTON, D. C. 20510

(202) 224-9491

July 30, 1982

Route 1, Box 52
Lucedale, Mississippi 39452
Phone: (601) 947-7147

202-224-9491

Mr. Ralph Oman
Staff Director
Criminal Law Subcommittee
Committee On The Judiciary
UNITED STATES SENATE
Washington, D. C. 20510

copy

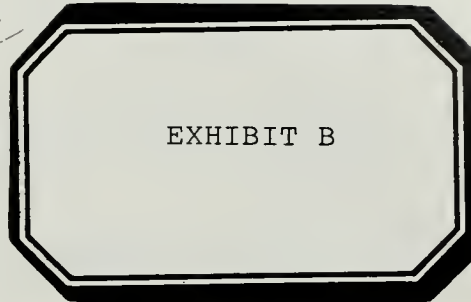

Dear Ralph:

I appreciate you meeting with me this week and introducing me to Paul. Please find enclosed a copy of a letter I sent to him today.

It would seem imperative to me that the Committee regarding improved patent procedures have earnest and dedicated input from "Inventors" (the creators), the individuals whom the sole purpose of patent procedures are and were intended to stimulate and to protect. Their feelings and needs can not be appreciated or truly anticipated by the "Non-Inventor" Individual who has not experienced their burning desire of the mind to be creative, which is most always discouraged and dampened by the trials and tribulations that most independent inventors usually experience. The one place that these unusual individuals should feel that they will find refuge, should be the Patent Office!

I would gladly participate and charge absolutely No Fee for this most worthy cause. I am sure there are others such as myself who would also participate in the same way.

It should be understood I am extremely honest, and will always state what I believe to be the absolute and fair solution to any problem. I despise rhetoric and always go right to the heart of any problem.

Sincere thanks and regards,

Joseph Westley Newman
Joseph Westley Newman

JWN/en
Enclosure

July 30, 1982

Route 1, Box 52
Lucedale, Mississippi 39452
Phone: (601) 947-7147

301-320-4327

Mr. Paul L. Gomory
5609 Ogden Road
Washington, D. C. 20816

Dear Paul.

It was enjoyable meeting and talking with you this week in Washington, D. C.

Please find enclosed the materials you lent me to make copies thereof.

I have carefully considered the words of our conversation.

I am sure you are correct, that I am my own worst enemy, when making points to individuals who are effected or reflected on by the points which I make in accordance with my own rigid and high standards of honesty and direct statements, which I expect to mean exactly what is stated or implied. (Part of this is probably my scientific training and discipline, that all statements should mean exactly what they imply regarding the subject matter under consideration.)

Anyway, I still feel with all my being that the problems I have encountered from the U.S. Patent Office on this particular invention are most definitely wrong and unjust. For such procedures to continue or expand will most definitely be to the detriment of creativity of the individual.

The Patent Office is an Institution of Science In Continuing Physical Expansion! In many instances the Physical Realization of a Property of Science, will precede the Scientific Explanation or Expectation of the Fact; by the Scientific Community.

The Examiners and Officials of the U.S. Patent Office have a sensitive and moral obligation to the encouragement of creativity of the Individual, which is the essence of the betterment of the Human Race. All the great advances in the betterment of the Human Race are not and were not made directly by kings, queens, politicians and etc., but were made directly by the Creative Processes of the Individual. The greatest and most lasting contribution to the

EXHIBIT C

Mr. Paul L. Gomory
Page two
July 30, 1982

human race that a politician or President can make is to initiate and set up procedures to encourage and protect creativity of the individual, in addition to the normal and decent rights of the individual.

As I have already stated, the Patent Office is indeed an "Institution Of Science In Continuing Physical Expansion". Therefore, Examiners and Officials of the U.S. Patent Office should most certainly wish to conduct themselves in a Scientific Manner.

Their statements should be interpreted to read exactly as the wording implies.

Their statements should require facts of Proof, exactly as is presently required of the applicant (the individual who is the creator and takes the drudgery out of life). Is the applicant not entitled to at least the same consideration as the Examiner ask of the individual who has made the contribution?

On Pioneering Inventions, the Examiner is at an extreme disadvantage. All of a sudden he has thrown upon him completely New Teachings which, in many instances, will go against what he was personally taught in his schooling. In such Pioneering Cases the Examiner should call in the applicant (the extreme creator) prior to making or taking action on the pioneering application for the purpose of being diligently instructed and taught the knowledge of these New Teachings. The law already requires that the Examiner make a thorough study thereof of the application. This does not mean that the Examiner simply read the New Teachings, but means he must master it!

It is very important for the Examiner's sake that he be taught and master these New Teachings of a Pioneering Invention. The reason being, many other inventions will follow pioneering inventions. They will be mere improved inventions, and not pioneering inventions. The Supreme Court has already ruled Liberality should apply to Pioneering Inventions. If the Examiner does not master the Teachings of a Pioneering Invention before all the improved inventions start pouring into the Patent Office, he will become even more frustrated because it will be difficult for him to quickly and exactly point out what is or is not patentable of the improved inventions in light of the existing Pioneering Invention.

Mr. Paul L. Gomory
Page three
July 30, 1982

In contrast to this procedure, after the Fact of the Final Rejection, I was personally advised by the Examiner and his Supervisor that neither one of them had even read the 130 page Document, that took me 15 years to complete and was legally made a part of the patent application. And is extremely important in understanding the "How" and "Why" and "Breadth" of this Extremely Pioneering Invention! Every page of that Document was literally an inventive process on my part, all consummating in a working prototype and the Technical Process of Releasing a New Source of Energy. At the time of the Final Rejection the Examiner had not even read said document, much less mastered it, nor had the Examiner even mastered the teachings of the Specification itself. I know because I talked with him shortly after the Final Rejection!

For the Supervisors of the Examiner (who are in essence judges of the Examiner's and the applicant's disagreements) to be allowed to fraternize with the Examiner, is totally unjust toward the applicant (who is the creator or contributor to the betterment of the human race). For this to be allowed is to ignore the facts of human nature! The law in the courts regarding Judges is quite explicit in this fact. If a Judge can even be considered biased or prejudiced (he does not have to be proven biased or prejudiced), he should excuse himself. Considering the extreme importance in setting up a procedure that encourages creativity of the individual and as a result thereof improves the well being of all, can we do any less than what is standard procedure in a normal court of law?

There appears to be a problem because of the closeness of the Examiners and their Supervisors all being on the same floor in the same Art Unit. Of one thing I am sure, no matter what the problem there is a solution. First, we must recognize there is a problem and, second, we must want to correct the problem and then search for the solution in a truthful manner and the solution will most certainly come.

It would seem to me an easy and improved procedure could easily be set up along the following lines:

A. The Director of each Art Unit must not have his office in the particular Art Unit. All of the Directors of All the Art Units be put on a floor with all of their offices together. They would then have camaraderie and could fraternize with each other without Jeopardizing the fairness toward an examiner or applicant. The

Mr. Paul L. Gomory
Page four
July 30, 1982

Directors do not perform normal Examiner procedures, therefore, they do not have to be in that Art Unit continuously to do their job efficiently. Also the Directors will all experience one or more problems that will be common to all Directors. They could easily meet every month or so and discuss solutions. The Directors of an Art Unit must have and maintain an air of respect and separability from the Examiner or the Applicant that is conducive with the power and the importance of the position given him. The fact that the Examiner has to go outside of his normal environment to address the Director in his office will have a most positive effect of getting responsible action from an Examiner relative to an applicant. Also the fact that the Director may make an inspection of his Art Unit at any time will also have a most positive effect on the Examiners and their immediate Supervisors.

The immediate Supervisors to the Examiners must also maintain separateness. The Supervisors can have their office in the same Art Unit area of the Examiners, but he must not be allowed to fraternize with the Examiners. If he is honest in wanting to be completely fair and unbiased, he should have no desire to fraternize with the Examiner, but to the contrary, should have a sincere desire to cut any ties he may have had with the Examiners back when he himself was an Examiner. They can not eat together, they can not fraternize after work. The Examiner's immediate Supervisor must sign pledges that they will not or do not fraternize with the Examiners.

The Examiners, the Examiners' immediate Supervisors and the Directors and all other Patent Officials should recognize and hold in Reverence the Moral Obligation to act in a manner that will be conducive to creativity of the Individual, and as a result thereof, to the betterment of the human race. They must protect the patents of the individuals which they grant, but at the same time they must be sure they give patents when deserved. And especially be sensitive to Pioneering Inventions (the Extreme Creator).

The procedure of the U.S. Patent Office must meet the requirements and needs of the applicant (the creator or contributor) and not be set up to meet unnecessary desires of Patent Office Employees, which are a detriment to the Inventor and a detriment to Creative Processes.

Mr. Paul L. Gomory
Page five
July 30, 1982

The problems I have written about I have personally experienced on the patent application, Serial No. 179,474, an extremely Pioneering Invention. The facts are in the record for all to see, who wish to see.

This invention, which I have worked so diligently and dedicatedly on for years, until it was perfected, will benefit the human race more than any other invention. It is very important to National Defense and National Economy, as it is to the entire world.

Any one or group which you could recommend that would be interested in assisting me in this important matter would be appreciated.

Sincere thanks and regards,

Joseph Westley Newman

JWN/en

Enclosures

cc: Mr. Ralph Oman

The reader should draw her/his own conclusions from the following FACTS:

- (1) Donald J. Quigg, the current Acting-Commissioner of the U.S. Patent Office, was employed as a top executive with a major oil company for 36 years before becoming the Deputy Commissioner of Patent and Trademarks on October 26, 1981.
- (2) A Federal Judge discussed in the following Chapter was appointed in 1982 by President Ronald Reagan. I have been informed by a number of individuals that President Reagan is very favorably disposed towards the oil industry.
- (3) Return to Chapter 20 (pages 169 and 170) and examine the response from President Reagan's office at the White House. An "in-house" memo (page 170) was **accidentally enclosed** with the cover letter signed by Anne Higgins. The cover letter indicates that it was not possible for President Reagan to comply with my request to examine the video film of my energy machine, yet the "in-house" memo indicates that the individuals at the White House recognized that the video film contained information of immense importance to the world and was viewed on March 3, 1984.

In addition to the above information, the facts of my Federal District Court Case 83-0001 in Washington, D.C., clearly demonstrates why the U.S. Patent Office must be immediately reformed.

"The Jewel of our civilization is its creative individuals!" Need I say more?

Chapter 25

THE JUDICIAL SYSTEM

"Every community has a right to demand of all its agents an account of their conduct."

— Thomas Paine
from his book, *The Rights of Man*

Following years of *injustice* at the hands of the U.S. Patent Office, my fight for *Justice* took me to the U.S. Federal Court where, much to my dismay, I discovered further *Injustice*. The specific *Facts* of my Federal District Court case only serve to exemplify such continuing injustice.

EXAMPLE: Enclosed is a News Release which indicates that I have been forced to file with the U.S. Court of Appeals a Writ of Mandamus against Federal Judge Thomas P. Jackson. Due to the precedent-setting magnitude of this case, my legal counsel has requested that all ten Judges of the U.S. Court of Appeals hear my case.

I sincerely recommend that the news media and concerned citizens/elected officials secure a copy of my Writ of Mandamus submitted to the U.S. Court of Appeals. The facts of this case speak for themselves!

However, for those individuals who are unable to secure a copy of the Writ, I have outlined several of the pertinent facts:

(1) At the first hearing in Federal Court, Judge Thomas P. Jackson proposed that a technically competent "Special Master" be appointed by the Court to evaluate my energy machine since the Judge stated that he had no scientific expertise. (A "Special Master" is someone technically skilled in the subject under consideration by the Court.)

(2) I objected to the Judge's proposal. I stated that the Judge did not need scientific experience since he had only to follow the Law and simply *count* the actual witnesses who have attested to the operability of my energy machine. I had more than 30 such witnesses and the Patent Office had *zero!*

I indicated to the Judge that a "Special Master" would only increase the unjust expenses I had already been forced to endure as a result of the illegal actions of the U.S. Patent Office.

(3) Judge Thomas P. Jackson insisted that both the Patent Office and I submit three nominations for Special Master. If both parties could not mutually agree on a single individual, then the Judge himself would select a Special Master.

(4) I nominated two highly-qualified individuals: a Professor of Electrical Engineering at Texas A&M, and a Ph.D. graduate from Auburn University who is presently a NASA employee at Huntsville, Alabama. To avoid having a "biased nominee," I had not met either of these scientifically-competent individuals. For the same reason, I did not nominate any of the more than thirty individuals who had already testified in my behalf.

(5) The U.S. Patent Office nominated three individuals for the position of Special Master. Two were only Patent Office employees who, by virtue of their employer, would be suspected of being biased and prejudiced against my case. The third Patent Office nominee was Mr. William E. Schuyler, Jr., a former Commissioner of the U.S. Patent Office from 1969-1971 with a degree in electrical engineering. Mr. Schuyler could also be suspected of being biased since he had worked for the Patent Office.

(6) Judge Jackson refused to accept my two nominees and instead chose Patent Office nominee William E. Schuyler, Jr., whose credentials were described by Judge Jackson as "superb." I agreed to accept Mr. Schuyler as Special Master since I believed him to be an honest individual. I had once met Mr. Schuyler in 1975 and so advised Judge Jackson and the legal counsel for the Patent Office. The Judge and the Patent Office still insisted upon Mr. Schuyler's becoming the Special Master. As a result, Mr. Schuyler was appointed as the Special Master to evaluate my energy machine.

(7) Within several weeks after receiving all Disclosure Documents and case history presented to the Court, Mr. Schuyler issued his *Report of the Special Master*, dated September 25, 1984, which contained very significant statements:

(A) "Evidence before the Patent and Trademark Office and this Court *is overwhelming* that Newman has built and tested a prototype of his invention in which the output energy exceeds the external input energy; there is *no* contradictory factual evidence." (*Emphasis added.* I described this *Report* earlier in conjunction with the Patent System discussion.)

John Flannery

Janney House
Waterford, Virginia 22190
703-882-3175

3847 North Tazewell Street
Arlington, Virginia 22207
703-534-7464

Contact: Susan Braaten, 534-2918 or 534-7464

INVENTOR NEWMAN DEMANDS DAY IN COURT (April 17, 1985).....
.... Inventor Joseph Newman, whose extraordinarily efficient machine works as he says, according to a former Patent Commissioner, asked the federal appellate court to order the U.S. District Judge handling his patent case "to do his job, to decide the case, and not to shirk his constitutional duty." In short, Newman demanded "my day in court."

Inventor Newman, fighting for five years for a patent for his device, said "the Patent Office wouldn't consider my invention on its merits and I can't get the District Judge to consider it either."

Newman said, " The Court appointed the former Commissioner of the Patents, no less, as his Special Master to say what the facts were to save us time and money. At least that's what Judge Jackson said. The Master found for me. He said there was 'overwhelming evidence' my device worked and that I was entitled to a patent. And he decided that quickly, by September 28th of last year. But Judge Jackson sent me back to the Patent Office and wouldn't decide anything. Now it's costing me time and money as the Court made me pay for the Master's fees and expenses."

John Flannery, a former federal prosecutor and Newman's counsel, said in papers filed with the U.S. Court of Appeals for the Federal Circuit that "the Court...having appointed a Special Master to determine what the facts were, had admittedly 'adjudged' nothing itself."

Flannery noted in his papers that:

"the Court said on October 31 it was 'not prepared' and was 'unprepared' to conclude anything. On January 31, when [Flannery] said 'nothing has changed' since the Patent Office's first rejection in 1981, the Court said, 'I don't know yet.' On March 14th, the Court said he gave the Master's Findings of Fact 'no effect whatsoever' and when asked if there were any facts the Court relied on in questioning the operability of [Newman's] device, the Court said, 'I'm not going to tell you now.'"

[See Petition for writ of mandamus at p. 30.]

Newman charged, "The Judge is not doing his job." John Flannery, a former federal prosecutor and Newman's counsel, said that "the law is that the District Court has a duty" to find out for itself what happened. Newman says that means, "The Court can't pass the buck back to the Patent Office as it has."

INVENTOR NEWMAN DEMANDS DAY IN COURT, page two

Flannery's papers include the unusual request that the entire Federal Circuit consider Newman's petition. Flannery says the case involves a "precedent-setting question of exceptional importance", namely:

"May a District Court that has appointed a Special Master to determine the facts but has itself admittedly 'adjudged' none of them, remand the civil action...[cites omitted]...to the Patent Office where [Newman] has already exhausted his administrative remedies requiring him to exhaust those remedies again and threatening him with abandonment of his patent application for his failure to comply with the extraordinary and unprecedented demands made of him upon remand?"

[See Petition for writ of mandamus at p. 1-2.]

The Patent Office has stated flatly that Newman will have abandoned his patent application if he doesn't bring from Mississippi and produce by May 30th "his [5,000 pound] operating prototype [in Maryland], [Newman's trial] evidence, notwithstanding that it might be withheld during the civil action, if not dismantled or destroyed."

[See Petition for writ of mandamus at p.4, 18-19.]

Flannery's papers refer to a case, Margolis v. Banner, where the Patent Office tried this before and the federal appellate court stopped them "dead in their tracks", according to Newman. In that case, the federal appellate court prevented "the Patent Office from using the threat of abandonment to force the [patent] applicant to give additional evidence after a final rejection. "

[See Petition for writ of mandamus at 37-38.]

Backwoods Inventor Newman, 48, of Lucedale, Mississippi, has been stonewalled in his efforts to obtain a patent for the last five years. Patent Examiner Donovan Duggan, a proven incompetent, according to one federal district court, told Newman after he issued his final rejection of Newman's patent application that he "doubted he would ever allow a patent on [Newman's] invention no matter what proof [Newman] submitted (emphasis supplied)."

According to Newman, U.S. District Judge Jackson appointed the Special Master last summer to make findings of fact because of the "substantial and contradictory submissions of record before the Court." Newman charges Judge Jackson did that in part because the patent office submitted a false affidavit contradicting one of Newman's experts but the affidavit was recanted too late -- after the Master had been appointed.

(B) Under the section entitled "PROPOSED CONCLUSIONS OF LAW," Mr. Schuyler wrote:

"Even though the operation of Plaintiff's (Newman's) system *seems* contrary to recognized scientific principles, Plaintiff has demonstrated the operation of his system by *very clear evidence* and is therefore *entitled to a patent* if he otherwise satisfies the requirements of the Patent Statute (35 USC). *In re Chilowsky* 229 2d45 (CCPA1956)" (*Emphasis added.*)

(8) *The U.S. Patent Office then responded to the Report of the Special Master by vilifying former Commissioner Schuyler and advising the Court to "exercise some common sense and refrain from joining those who apparently still believe in the tooth fairy."*

Such an irresponsible remark by the legal counsel for the Patent Office was made *against their own nominee* — a nominee appointed by Judge Jackson who stated that the credentials of the Special Master were "superb"!

(9) Amazingly enough, Judge Thomas P. Jackson refused to accept the Special Master's findings of fact with respect to the operability of my Pioneering Invention. Such a refusal was issued by a Judge who had already clearly admitted that he possessed *no* scientific credentials.

Even though Judge Jackson had no evidence to contradict the findings of Special Master Schuyler, and even though the Patent Office was also unable to present any evidence to refute the *Report of the Special Master* — Judge Jackson *still refused* to accept the Special Master's findings of fact and refused to instruct the Patent Office to issue me a Pioneering Patent.

(10) Rule 53(e)(2) of the Federal Rules of Civil Procedure, 28 U.S.C.A., provides that in a non-jury action, "*the Court shall accept the Master's findings of fact unless clearly erroneous.*" Both the Judge and Patent Office failed to present *any* "clearly erroneous" evidence.

(11) Judge Thomas P. Jackson then ordered me to pay \$11,602.20 for the *Report of the Special Master* — a *Report* which I had originally objected to as an unnecessary expense and a *Report* which was written by a man who was selected by the Court because Judge Jackson admitted that he was technically unqualified to judge the issues.

(12) Judge Thomas P. Jackson then placed the further disposition of the case **right back in the hands of the Patent Office** by ordering a remand to that office. In effect, I was "returned to square one" and once again forced to face the injustices of the Patent Office. This remand occurred *after* numerous court hearings, thousands of dollars in legal expenses, and an \$11,602.20 *Report of the Special Master* which endorsed the operability of my energy machine!

(13) I advised Judge Thomas P. Jackson that the "power" of the Honorable Court *was not "his power," but that as a Judge he was only a custodian of the "Court's Power."* For the Judge to charge me \$11,602.20 for a *Report* which he refused to accept and then to order me to once again submit to the capricious behavior of the Patent Office — such judicial actions only *endorse* the Injustice I have been forced to endure for over five years.

(14) Because Judge Jackson refused to correct his deliberate injustice, I instructed my attorney to file against Judge Thomas P. Jackson a Writ of Mandamus in the United States Court of Appeals for the Federal Circuit to which action my attorney readily agreed and further requested a Hearing In Banc, i.e., for all Appellant Judges to hear the Writ. As of this writing, both the U.S. Court of Appeals and the U.S. Supreme Court have refused my Writ of Mandamus and have continued to endorse the injustice initiated by the Patent Office and the Federal District Court. Such injustice proves that changes in our judicial system must occur.

I sincerely ask that the news media, elected officials, and concerned officials obtain a copy of the Court file with respect to my case. The injustice of which I write is fully documented!

I wish to pay tribute to my excellent attorney:

John P. Flannery, II, Esquire
555 Fourth Street, N.W., Suite 333 (202) 737-5708
Washington, D.C. 20001 534-7464

Possessing an intelligent and sharp mind, Mr. Flannery is more willing to "Fight for Justice" than any attorney I have ever met! Having only inherited and handled my case for several months, Mr. Flannery has fully and completely "mastered" a massive legal case.

My legal case actually represents an ideal example of the urgent need for an extreme change in the "Arrogant Authority" automatically and blindly given to Judges.

I have no doubt that there are many honorable Judges in the Judicial System who are a credit and compliment to their profession. However, the facts prove that there are many Judges whose arbitrary behavior justifies the immediate curtailment of such power with a proper system of checks and balances.

I make such a statement not because I dislike Judges, but because I have the *greatest respect and admiration* for those Judges who truly have been an asset to their profession and have consistently exhibited the very *essence of Justice*. Rather, *I make the above statement because I "love, cherish, and am devoted to Justice" while I totally despise and condemn all Injustice!*

It is for you, the public, that I write. I urge you to use your Mind to *question, think, and then act* in a manner based on Truth and Justice. Do not be complacent and unknowingly permit the "powers that be" to repress you and your loved ones. To permit Injustice to occur is to show contempt for the principles developed by the Founders of our "free" country.

The following Facts I have observed verify the truth of my statement concerning judicial abuse of power.

FACT 1: Numerous attorneys have informed me of their belief that Judges possess "Awesome Power." Nine out of ten lawyers conduct themselves in a manner that reflects their fear of such power.

CONCLUSION FROM FACT 1: Such a belief is **totally** wrong! A Judge does not possess "Awesome Power." *A Judge is only a custodian of the Honorable Court's Power. The Court belongs to the Justice "of the People" — not "of the Judge"!* Just as a grown person would avoid hurting a baby, a Judge has an even greater moral obligation not to abuse the "Power of the Court." A Judge who misuses such conferred authority should be judged accordingly.

Any Judge who conducts herself/himself as though the Power of the Court *is* the Judge's Power should be immediately disrobed and replaced! No lawyer can properly represent her/his client (the People) if that lawyer believes the Judge possesses "Awesome Power."

FACT 2: Many attorneys have personally told me that I should not file a Writ of Mandamus against Judge Thomas P. Jackson! Such lawyers reason that, even if I win my case in the Federal Court of Appeals, I must still return to Judge Jackson's Court for further disposition. When this occurred, the lawyers' opinion was that Judge Jackson would very likely try even harder to serve me *Injustice*.

CONCLUSION FROM FACT 2: In itself, Fact 2 demonstrates that Judges must be held responsible for their actions. Extremely strict judicial codes *must be enacted* since *Justice* cannot be served to attorneys' clients (the People) when such attorneys believe FACT 2 and conduct themselves accordingly.

FACT 3: I have been informed by many attorneys that most Writs of Mandamus are rejected or opposed by higher courts because all Judges wish to "protect their own members" to an extent greater than that in other professions.

CONCLUSION FROM FACT 3: Such a Fact demonstrates the same conclusion as that expressed for FACT 2!

FACT 4: It is well known that Federal Judges are appointed by politicians. It is also well known that many politicians cater to "special interests." Furthermore, many sensitive individuals anxiously await such appointments to determine if a Judge is politically "Conservative" or "Liberal."

CONCLUSION FROM FACT 4: In themselves, the words "Conservative" and "Liberal" clearly demonstrate *biases and prejudices* — NOT JUSTICE. The "special interests" support politicians who appoint to Federal Judgeships specific individuals which the politicians hope will issue "Rulings of Law" which are favorable to the "special interests" that support the politicians. It is indeed a "vicious cycle" that is vicious in its denial of *Justice* to the People.

FACT 5: Judges have the power to determine whether a case will be tried by a Jury (the People) or by the Judge. One of the reasons for the existence of the Declaration of Independence is that the Founders of our country knew that the Colonialists had suffered the injustices of a corrupt judicial system. As it specifically states, the Declaration of Independence held the King of England in contempt "for depriving us in many cases of the benefits of Trial by Jury."

In my case, I have been denied a trial by a Jury (the People). The reader should find it significant that an official of the U.S. Patent Office readily admitted to my attorney that "*they (the Patent Office) would hate to have my case tried by a Jury (the People)!*"

Judges attempt to justify their trying a case instead of a Jury by saying that "*People (a Jury) can try a case concerning Facts, but only Judges should try a case concerning Law.*"

**"... they (the Patent Office)
would hate to have my case tried
by a Jury (the People)!"**

CONCLUSION FROM FACT 5: The Founders of our country realized that Judges were often the pawns of "special interests" that influenced politicians, who in turn, appointed the Judges. It was for this reason that our Founders stressed the importance of Trial by Jury (the People).

If a statement represents the "Law," then such a statement is a "Fact of Law." Consequently, the members of a Jury (the People) are entitled to hear a case concerning the "Facts of Law." The Jury would simply be provided with the "Facts of Law," just as the Jury is provided with other Facts. A FACT IS A FACT, and any attempt by a Judge to claim otherwise only represents a ploy to deny the "People" a trial by a Jury (the People).

The "People" should be granted a Trial by "Jury" whenever the client (the People) request it.

Justice is not something learned from the blind memorization of a Law book. *Justice* is a natural instinct for anyone who devotes his life to living such *Justice*.

EXAMPLE: There are Judges who exemplify proper judicial behavior and are true administrators of *Justice*. Consider a Judge who has publicly opposed abortion due to the respect for and acceptance of a religious teaching but has judicially ruled in favor of "abortion" due to an acceptance of the "Essence of Justice" and the "Facts of Law."

Consider the internal conflict experienced by such a Judge! Yet such a Judge recognized that the "Facts of Law" have demonstrated in previous centuries that many religious teachings only served to promote *Injustice* rather than *Justice* to the People. In respect for the "Facts of Law," such a Judge rendered a decision which was most likely — in her/his opinion — to properly dispense *Justice* to the People. The Founders of our country had very clearly expressed the necessity for the separation of Church and State.

I salute those Judges who have always conducted themselves in a manner which demonstrated they were "custodians" of the "Power of the Honorable Court!" Such judicial conduct also demonstrates their recognition that such "Power" was not to be used to promote their personal biases and prejudices. Such is the "Essence of Justice."

I am well aware that there are many religious individuals who have good intentions but would vigorously disagree with the above statement concerning "abortions." This is certainly a very sensitive and emotional topic. I must stress that I do not wish to offend such individuals. My only intent is the rigorous pursuit of Truth and Justice.

QUESTION: Why do many religious individuals have such an attitude concerning "abortion"?

ANSWER: Because they were so taught and taught not to question.

QUESTION: Have I been able to convince you that your Mind is a precious, God-given gift which God expects should be consistently used to Question and pursue Truth?

QUESTION: Have you not been taught that God is "merciful"? I am certain your answer would be "Yes."

QUESTION: Do you believe it likely that a merciful God would deliberately and intentionally cause children to be born in Ethiopia — only to live in misery for days, months, or years and then to die of starvation?

QUESTION: Do you believe it likely that a merciful God would deliberately and intentionally cause children to be born with severe mental and/or physical handicaps — handicaps which cause great suffering for the children and anguish for their parents?

QUESTION: Do you believe it likely that a merciful God would deliberately and intentionally cause children to be born to parents who do not want them — or to parents who cannot support them and provide proper teachings, guidance, hope, pride and *love*? A child born to such parents would only experience a life of misery and hopelessness, as well as a life possibly devoid of skill and personal pride in their ability to contribute to civilization.

Permit me to offer the following *FACT* for your *questioning* and *thinking* consideration:

FACT: Miscarriages or "natural abortions" which occur in early pregnancy are generally the result of abnormal development within the embryo or within the protective and nutritional structure derived from the trophoblast.

QUESTION: Do you think it possible that God (the Essence of Mercy) has mercifully placed such an automatic governing mechanism in the female human body and in the embryo in order to prevent some of the above-described misery from occurring?

QUESTION: Do you not think it possible that God (the Essence of Mercy) instilled Mercy within us as well as a Questioning, Thinking Mind and Free Will? Is it possible that God recognized that human action may be taken to terminate a potential human being born into a life of physical and/or mental misery — a potential human being "missed" by God's "merciful and natural safeguard?"

THOUGHT: Consider the possibility that the physical body is not the essence of the "Soul" which remains in "limbo" until the birth of the physical body. When the physical body

is born and grows, the "Mind" proceeds to develop a sensitivity to right and wrong, and thereby brings the "Soul" out of "limbo."

QUESTION: Do you not understand why many people accept "abortion" since, in many instances, such "abortion" could be considered "merciful?"

QUESTION: Do you not understand that to impose your belief upon those who accept abortion by saying that "they could not have an abortion," would be as *unjust* as those who accept abortion, imposing their belief upon you by saying that "you must have an abortion?"

Perhaps you can now have greater respect and appreciation for those Judges who demonstrate a custodianship of the Power of the Honorable Court which strives to only serve Justice to the "People."

It is most important, however, that the People and the news media apply safeguards to Judges to ensure that such Judges serve "Justice to the People" rather than serve biases, prejudices, and/or special interests.

The judicial injustices I have described must not be allowed to continue unchecked by the U.S. Supreme Court and Congress. To permit such injustice to occur would only constitute a signal to the U.S. Patent Office that patent officials can initiate against creative individuals *any* form of injustice without fear of punishment. Such injustice would only serve to discourage innovators from creating inventions which benefit all humanity.

I am also well aware of certain individuals throughout the country who have copied my invention and who attempt to claim the invention as their own. It is historically known that Glenn Curtiss attempted to steal the invention of the aeroplane from the Wright Brothers. Fortunately, history has done justice to both the Wright Brothers and Mr. Curtiss.

I sincerely appeal to the people of this country and the world to help stop Patent Office/judicial injustice and work to ensure that all inventors and benefactors of humanity secure the fruits of their labors. If you truly care for such justice, then I urge you to write your Senators, Representatives, as well as the President of the United States — and clearly demand that justice be served.

The injustice I have described would *totally* discourage creative individuals from pursuing Pioneering Inventions.

One individual, who has already publicly denounced my Pioneering Patent Application as worthless, has nevertheless attempted to steal my Patent Application rights by filing a patent application which utilizes my Technical Process. Such negative philosophy and destructive action is fostered by the unjust actions of the U.S. Patent Office/judicial system, and only serves to further discourage creative and pioneering individuals. It is *the people* who are the true victims of this unjust process.

You — the people — have power. EXAMPLE: When Injustice to a Patent Application has occurred, your elected officials in Congress have the power to directly Issue that Patent.

I sincerely ask you to question and think. Throughout history, when justice does not occur, rebellion and in many instances anarchy have resulted. In a quick and orderly fashion, you have the *power* — by your vote and/or recall of elected officials — to "alter or abolish" any form of government which is or becomes unjust. Such a right, duty, and power was clearly stated by Congress on July 4, 1776 in the Declaration of Independence and paid for by the blood of many of our ancestors. To allow injustice to occur is a mockery of the very essence of what America represents. Need I say more?

Chapter 26

THE PURSUIT OF TRUTH

"I have always found that the honest truth of our own mind has a certain attraction for every other mind that loves truth honestly."

— Thomas Carlyle

As I conclude this final Chapter, I feel a burden lifted from my shoulders. In slightly more than two months, I will be 49 years old. For nearly 50 years, I have deeply cared for humanity and strived to improve the quality of life upon the planet.

For over 20 years, I have fought for you, the *People*, who are now alive or who are yet to be born.

Many of my closest friends have sincerely urged me to include only topics relating to pure Science in my Book rather than these other numerous subjects. My friends are concerned that you, "the People," will dismiss *all* of my work if you become offended by *any* subject that I have discussed.

I told my friends that I fully recognize this possibility, and yet it does not deter me in any way. The reason is simple. *I am not promoting Joseph Newman! I am promoting you, "the People," and urging you to recognize*

Such a new, *Single Language* must be based on "Consistent Logic" (similar to mathematics) rather than memorization and imprecision. Present languages are deficient in strict logic and only serve to interfere with the creative processes one enjoys when writing one's work. I write from experience. This new, *Single Language* can be achieved if we "Question, Think, Create, and Act!"

The young children throughout the world who are taught such a new, *Single Language* will automatically feel *closer* and *less suspicious* of the children of other countries. When such children become adults, they will be more eager to *talk, share, solve, care, and produce* "Peace, Love, and Goodness."

I have provided for the world a Unified Field Technology and a New Energy Innovation which I sincerely believe — if used *creatively* — will do more to generate

"I have provided for the world a Unified Field Technology and a New Energy Innovation which I sincerely believe — if used creatively — will do more to generate World Peace than the efforts of all the Kings, Queens, Presidents, Dictators, etc., who have ever lived."

the "Sleeping Lion" that lies within you. I urge you to stir yourself, "Awaken," and begin to Question, Think, and Act to produce "TRUTH" which equals "Goodness."

I believe in you, "the People," more than you believe in yourselves.

We have been given a most precious gift: a Powerful Mind capable of Questioning, Reasoning, Thinking, Creating, Loving, being Merciful, Acting, Seeking, and Producing Absolute Truth, which equals Goodness!

So, teach your young children and stimulate their curiosity — this will do more toward producing a "meaningful, happy life" for your children than all the dogma you received via a non-educational process of memorization.

I have been discussing the "happiness," the "well-being," and the "future" of our children and of children yet to be born. To achieve and ensure these desirable goals, I warmly recommend that a *Single Language* be developed and taught on a worldwide basis to supplement conventional languages. This new, *Single Language* must be independent of any other known language in the world.

World Peace than the efforts of all the Kings, Queens, Presidents, Dictators, etc., who have ever lived.

But for this to occur, it is imperative that we teach our young children to *Cherish* and *Use* the Natural Birthright of their Questioning Minds — and always, yes, always, seek the Pursuit of *Absolute Truth* which equals *Goodness*.

The energy technology I have innovated when combined with the "Merger of Economics and Mechanization" will result in a most beneficial working life and *Meaningful Life* for all humanity. I can envision the time when you, the "People," will only need to work no more than one hour a week (and possibly less) to achieve the material things of life necessary to enjoy an adequate physical existence for your family.

There are those unthinking Doomsayers who will blindly state that "If people only need to work an hour or less each week to live, then such people will become *worthless*."

I shout in response: NOT SO! I see the Truth of what I write via the "twinkling of the eyes" of our young children — especially those who are five years old or

less. Such young children need not work to live. Yet such children are consistently motivated to "Learn, Understand, Improve, Please," and most of all to "Love."

I shout the following: Take this natural Birthright, stimulate it, and nurture it to maturity!

If this is done, then whatever profession our "youth" pursue, they will strive to achieve a result which will be beneficial to themselves and the beholder (the People).

If children so stimulated become adults that only need to work an hour or less a week for conventional necessities — then such an adult with a "Stimulated, Natural Birthright" would consistently be productive, creative, and generate meaningful endeavors. Such endeavors would result in even greater beauty and significance to the beholder (the People). Such pleasing results consistently enjoyed by the beholder (the People) would only further stimulate the *People* to be constructive for one another.

If People have been taught what is truly important in life, then they will realize that caring and sharing for the benefit of *others* — and not material acquisition — can only bring happiness.

I speak from years of experience. *I truly physically and mentally hurt* when I see *People* suffer misery, despair, and unhappiness! *I smile* when I see *People* "smile, care, love, share, are constructive and produce Goodness."

I am smiling now, because I can envision the *positive results* for the *People* of the future who are educated as

We are composed of the same Gyroscopic, Electromagnetic Energy throughout the Universe, and the fluctuations of such energy affect us physically and mentally. This indicates that a new electromagnetic mechanism can be developed and installed within a human habitat or carried on a person which would be physiologically/psychologically beneficial. [It should be obvious to the individual who assumes the responsibility for such a device that the effects of electromagnetic energy can be beneficial or harmful, depending upon how employed.]

I have endeavored to increase your awareness that your "brain" is a *Powerful Electromagnetic Generator*, as well as a *Receiver* of Electromagnetic Waves. Your only limitation is the limitation you place upon yourself. **It is more than likely that anything you can imagine is possible!**

I envision space travel becoming commonplace within twenty years. There will be a continuous Source of Energy and the ability to travel to other Solar Systems *at the speed of light or possibly faster.* * [*I have given this subject much thought and I have developed a technological hypothesis for the means to achieve speeds exceeding that for light.]

There will be an end to environmental pollution caused by processes involving coal, oil, gas, or nuclear fuels.

Deserts can be transformed into "oases." Salt water can be readily and inexpensively converted into fresh water with the extracted minerals being used productively. *And on and on!*

I repeat — *I am made humble by the realization of*

"I am made humble by the realization of the Ingenious Workings of Our Universe."

I have described. If I have succeeded to any degree in contributing to that "Goodness" of the Future, then I sense a *deep, inner peace* which is beyond all worldly, material wealth. Even at this instant, *I smile peacefully and warmly with tears in my eyes for the young children of the world who are yet to be born.*

With all of my inner-being, I speak to all young children: "You can accomplish anything — **anything** — *to which you wish to apply your Powerful Mind.*"

It does not seem improbable to me that the gyroscopic energy comprising electrical and magnetic fields of **matter-in-motion** can be utilized in the proper mathematical combinations and proportions *to create any substance in the Universe.*

It does not seem improbable to me that "aging" and "disease" can be fully controlled and reversed via this same energy.

How is the human body composed and how does it function? — by Electromagnetic, Gyroscopic Energy!

It does not seem improbable to me that the mind is fully capable of feats that have yet to even be imagined.

The physical basis of E.S.P. may be easily explained by the laws of electromagnetic induction.

I am quite certain that the entities which I have worked on throughout my life will be "toys" to future children and are very likely already toys to children inhabiting other Solar Systems.

the Ingenious Workings of Our Universe. I strive to bestow in the reader's mind the visions of *grandeur* and *excitement* which I see so clearly for the future. Such visions lie within our immediate grasp and especially the grasp of our *young children.*

I now conclude twenty years of my life's work. I hope that I will contribute even more in years to come. Remember, if I think you "hurt," then I hurt for you. If I think you "smile," then I smile with you.

I send my love to you and I hope you will "multiply" *your love to others.*

I conclude this Book with a note from my writings dated Friday, 9:00 PM, April 19, 1968:

"To all peoples whose brain burns and aches to accomplish great things and changes for the good, may God and/or the Goodness of the Universe be with you. For you are the Goodness of the Universe and do good for people in spite of themselves. *And I salute you!*

Joseph Westley Newman
Lucedale, Mississippi
April 21, 1985

Appendix

(The items discussed below have been added to the Second Edition.)

I. Several readers of the First Edition have requested greater detail concerning test 14-F on page 17. The following represents the requested information:

The reason test 14-F convinced me that copper is "extremely magnetic" is the very fact that I do not accept the belief that one can "get something from absolutely nothing." Test 14-F clearly proved that a force was being produced and exerted between the wires of Figure 14-F2. For *any* force to exist, there must be energy participation, *i.e.*, the energy must be released from a source and this energy must be accounted for.

The results of test 14-F clearly told me that the *additional energy of this force* was not accounted for by the electrical energy input from the battery.

Since my prior work had enabled me to mechanically understand the essence of magnetism, *i.e.*, atom alignment and the subsequent release of gyroscopic particles (representing the mechanical essence of $E = MC^2$) to generate an electromagnetic field, I immediately recognized that the additional energy which produced this Unobvious Force had to originate from the atoms of the copper conductor. Consequently, I realized that while copper *is* extremely magnetic, it is also mechanically different from conventional magnetic materials such as iron, etc.

If one simply examines the Facts, such a recognition of copper's magnetic nature should be easy to grasp.

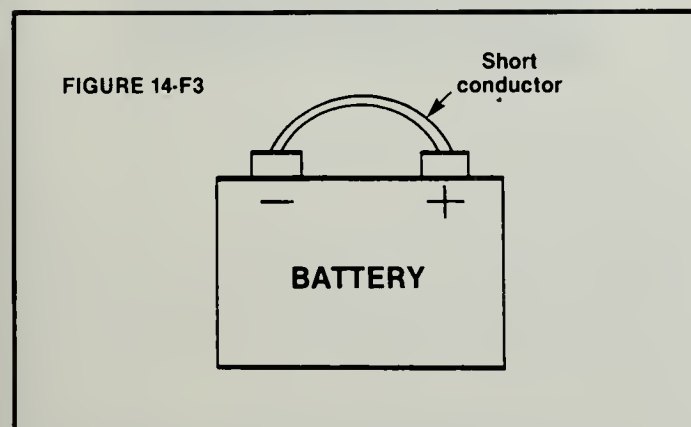

If one shorts out a battery via a short conductor as in Figure 14-F3, the result will be high current or "high power output" into the conductor. However, such a configuration would produce a very weak magnetic field. REASON: There are very few aligned atoms (less than 1 ounce) within the conductor. Moreover, such a

configuration would be incapable of causing the rotation of the 700 lb. magnet as shown in photograph 15-C1, on page 21.

14-F4. If the conductor is extremely long as in photograph 15-C1, page 21, then the 700 lb. magnet *will* rotate. REASON: There are vast numbers of aligned atoms within the conductor which weigh thousands of pounds.

With such a configuration, the 700 lb. magnet will not only rotate and produce "Obvious Work," but the vast aligned atoms of the massive coil will release *gyroscopic particles*, *i.e.*, electrical energy output whose current flow opposes the input current from the battery into the massive coil.

One should note, however, that the release of the gyroscopic particles from the atoms of the massive coil and from the atoms of the rotating 700 lb. magnet occurs *after* the "Fact" of the initial minute input current from the battery. The small input current represents the Hydraulic Pressure Effect (Voltage) originating from the atoms of the battery. Simply put: The 700 lb. magnet rotates *after* the atoms of the massive coil align which align *after* the "Fact" of the initial input or "Hydraulic Pressure" (voltage) from the battery. The proper timing of the hydraulic pressure (voltage) to fire/not to fire via a commutator results in 100% conversion of matter into energy in accordance with $E = MC^2$. The system *also* produces energy at the moment that the Hydraulic Pressure (voltage) from the battery is broken and the atoms of the massive coil become unaligned, *i.e.*, a collapsing magnetic field induces additional current.

Several readers have also asked: "How do the conductor's atoms align in order to cause a magnetic field to encircle the conductor?"

[Refer to Figure 14-B1 on page 15 and Figure 25-P on page 77.]

ANSWER: The atoms of a conductor (which is normally a *rounded* copper wire) align in a circular configuration.

EXPLANATION: This Fact can be demonstrated by placing small magnets in a circle around a non-magnetic tube composed of plastic, rubber, etc., in order to create a hollow-shaped disc. Using a thread, one should hang the disc 3-6 inches above the larger magnet. One will observe that the magnetic disc aligns with its center at right angles to the larger magnet as shown in Figure 14-B1a:

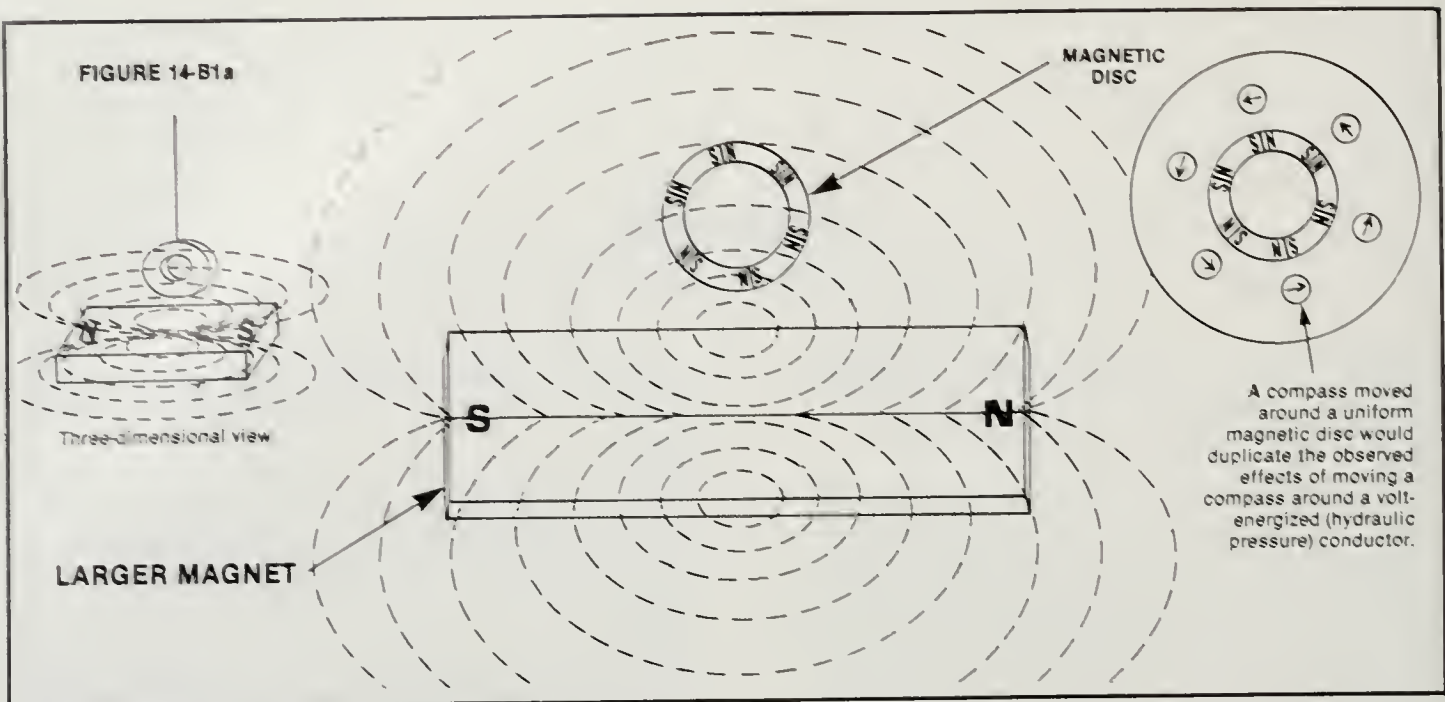

This fact clearly explains why a magnet aligns at right angles to a current-carrying conductor and why a conductor aligns at right angles to a magnetic field.

One should also realize from Figure 14-B1a that if numerous magnetic discs were placed side by side, one would have a cylindrically-shaped rod () — similar to a conductor rod or wire — which would align itself at right angles to a magnetic field. Or, viewed from another perspective, the magnetic field would be aligned at right angles to the cylindrically-shaped rod. This fact is further verification of statement 25-O(3) on page 76 as well as the entire discussion on pages 76-79 concerning the gyroscopic-particle-plane of matter.

II. ADDITIONAL WEATHER DISCUSSION (see pgs. 144-153)

Recently, I observed and experienced Hurricane Elena whose seemingly erratic path of movement over a period of several days completely baffled conventional weather experts. As a result of such movement, such experts readily admitted on local news broadcasts that they had *no idea* where Elena would finally land on the Gulf Coast.

As a result of the weather experts' inability to accurately predict landfall, inhabitants of the Gulf Coast from Florida to Texas became extremely concerned over uncertain and conflicting weather reports. In fact, many inhabitants of Florida were totally caught off-guard due to an abrupt and seemingly "unpredictable" sharp turn of Hurricane Elena towards the western Florida coast. One of these was a personal friend of mine in Fort Myers whose young son was camped with others on an island off the Florida coast. My friend thanked me for calling him at 2a.m. to inform him that Hurricane Elena was nearby.

It is with concern for the "people" that I stress that caring weather experts must *master* my teachings and combine this knowledge with conventional meteorology. This would enable weather experts to predict more accurately hurricane landfall and satisfactorily explain the erratic paths often assumed by such storms.

To "open the reader's mind," I present the following photograph and description from page 102 of the TIME-LIFE Book entitled *Planet Earth: STORM*.

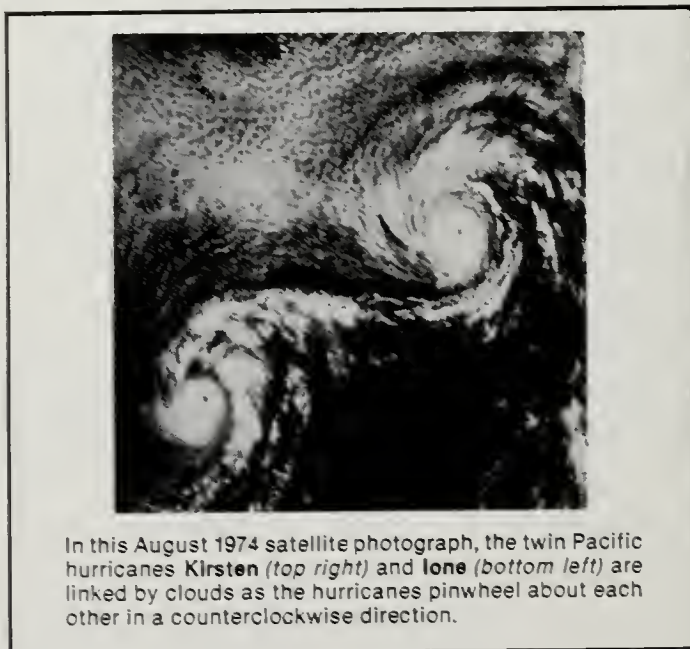

QUESTION: How do the hurricanes attract one another and why do they not come together? (The two hurricanes began attracting one another at separation distances up to 900 miles, thus proving that the "attraction force" is noticeable.)

ANSWER: Understand their *electromagnetic* nature!

Study carefully Chapter 3, page 13, beginning with the first paragraph in the left column and ending at the bottom right column.

You will note in Figure 13-H1 that the ends of two bar magnets placed N to S to one another will attract one another.

other. When the same two magnets are *shifted sideways* with respect to one another, *repulsion* will result.

You will also note in Figure 13-H2 that the ends of two bar magnets placed N to N to one another will repel one another. When the same two magnets are *shifted sideways* with respect to one another, *attraction* will result.

If the reader has Mastered my teachings then it should be obvious that the Pacific Pinwheel Cyclones represent *electromagnetic* phenomena.

Let's consider the view that the Pinwheel Cyclones have identical polarity orientation upon the Earth's surface, *i.e.*, a South to South and North to North polarity orientation.

Consider the fact that the Earth's surface is curved — a curvature even noticeable on the seas at a distance of only 12 miles. Consequently, there would be very noticeable curvature between two points on the Earth's surface separated by a distance of 900 miles.

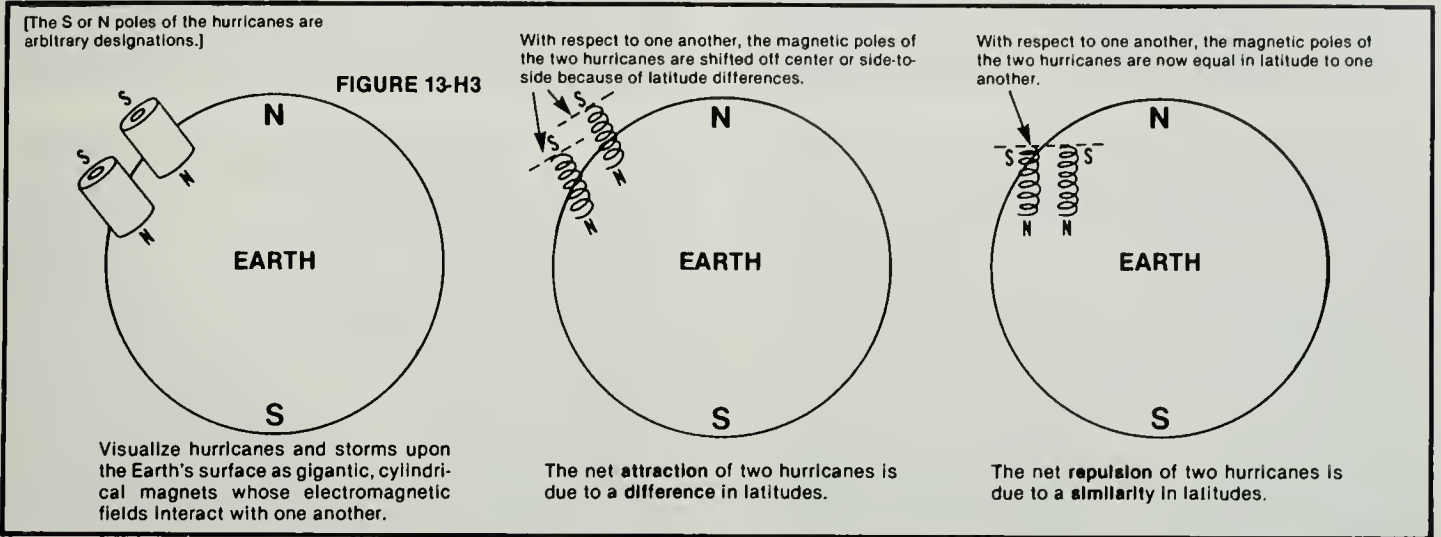

Observe in Figure 13-H3 that the Pinwheel Cyclones are located at different latitudes upon the Earth's surface. Consequently, their S to S magnetic repulsion effect has been shifted to the side of one another (as the bar magnets in Figure 13-H2) causing a net *attraction*. If the two Pinwheel Cyclones continue to attract one another to the point of latitude similarity, then *repulsion* would result and separation would be maintained.

It should become obvious to the reader that the electromagnetic effects of storms will need to be carefully studied in addition to pertinent meteorological data.

Let's return to Hurricane Elena.

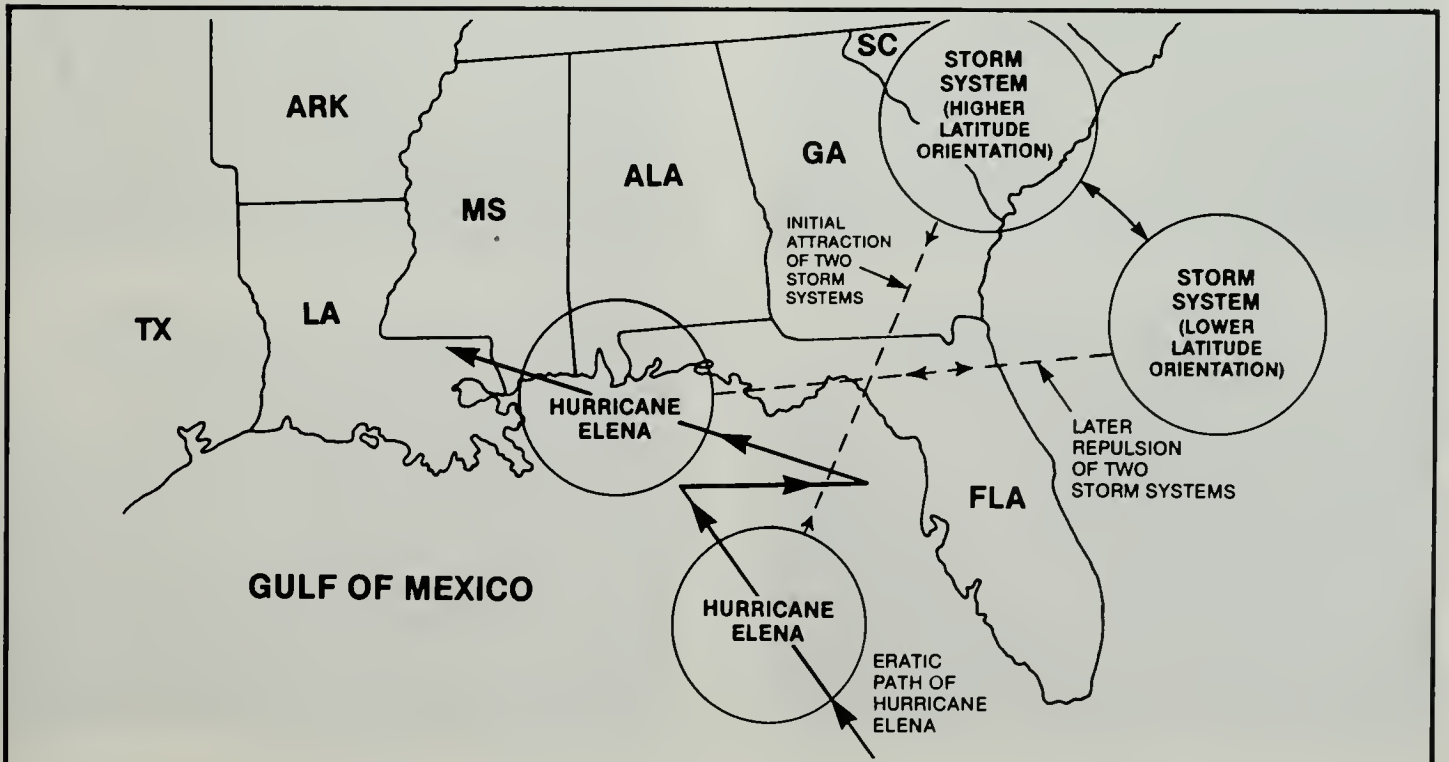

SATELLITE PHOTOGRAPHS OF HURRICANE ELENA — 1985, AUGUST 28 - SEPTEMBER 2

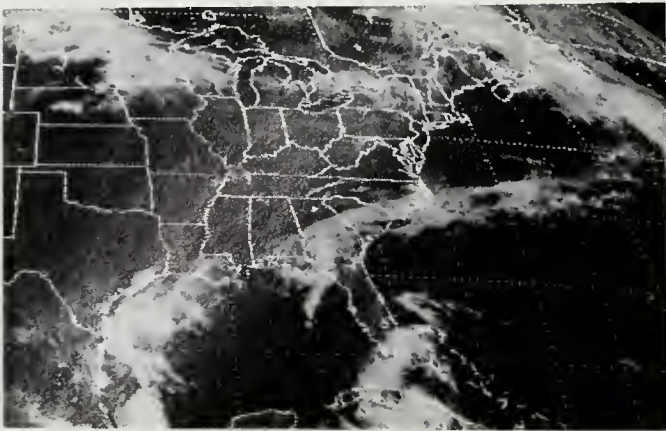

(1) VISIBLE LIGHT — 1985, August 28

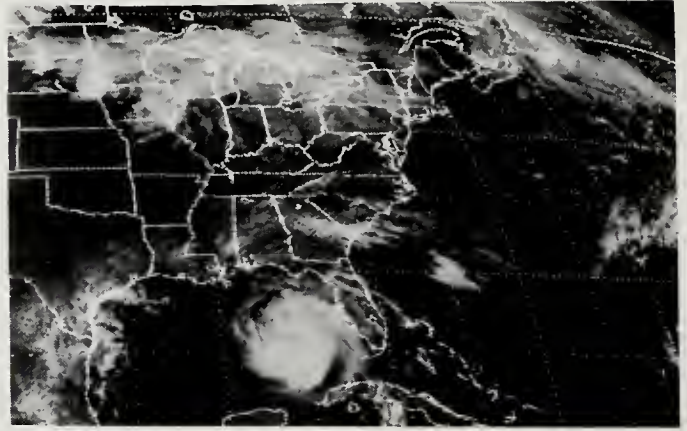

(2) VISIBLE LIGHT — 1985, August 29

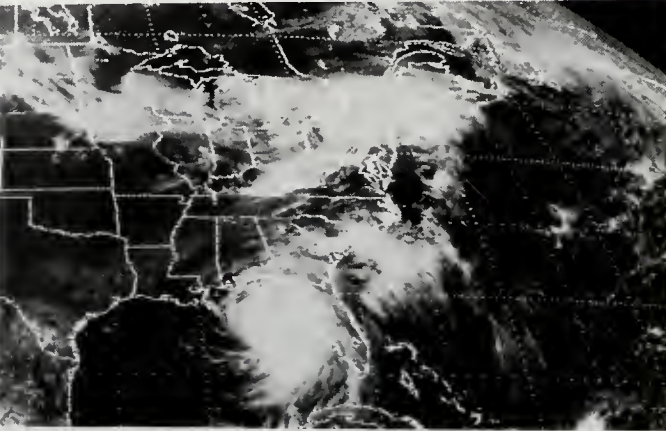

(3) VISIBLE LIGHT — 1985, August 30

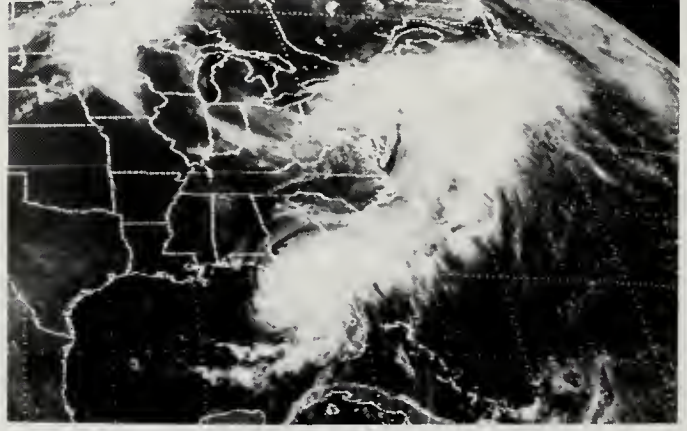

(4) VISIBLE LIGHT — 1985, August 31

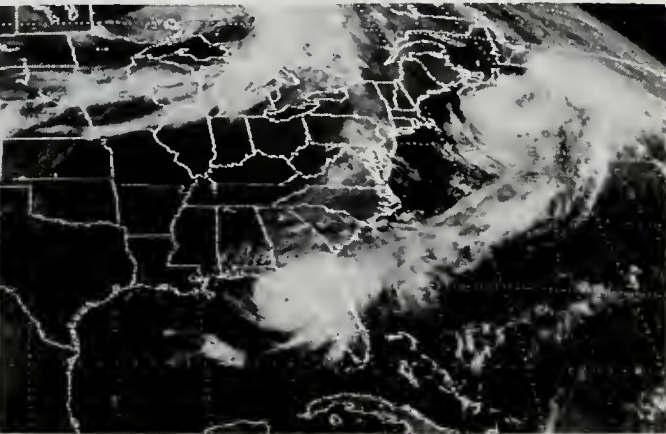

(5) VISIBLE LIGHT — 1985, September 1

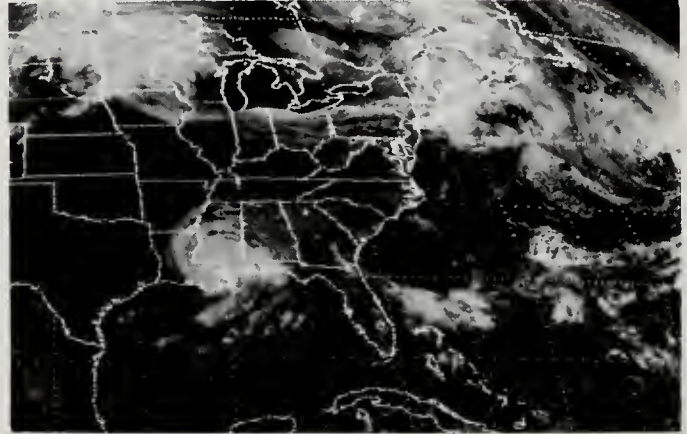

(6) VISIBLE LIGHT — 1985, September 2

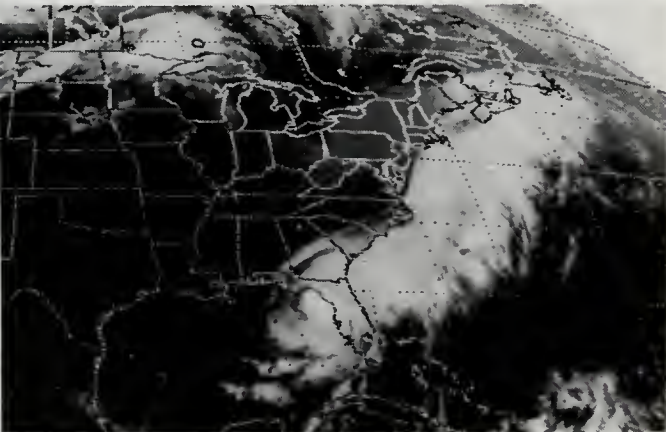

(A) INFRARED LIGHT — 1985, August 31



(B) INFRARED LIGHT — 1985, September 1

Courtesy of Satellite Data Service, NOAA

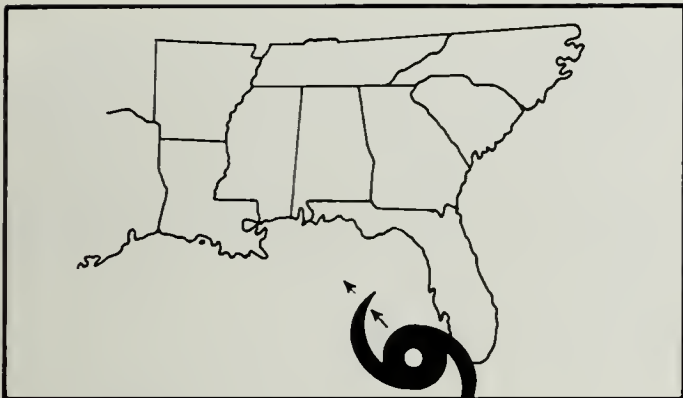

(1) Hurricane Elena enters the Gulf of Mexico.

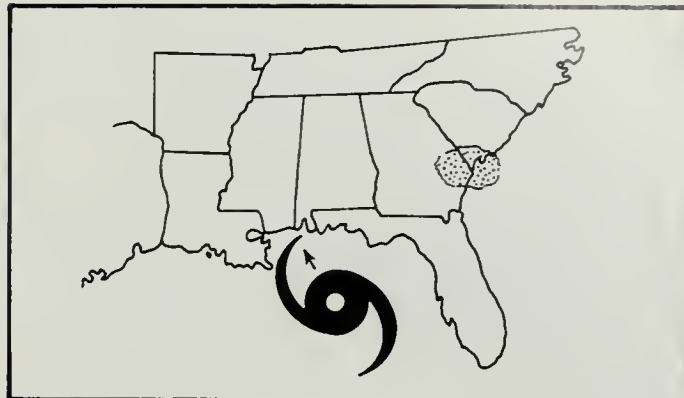

(2) Hurricane Elena moves towards the Mobile Bay area. [Another storm system begins to develop over Georgia and South Carolina.]

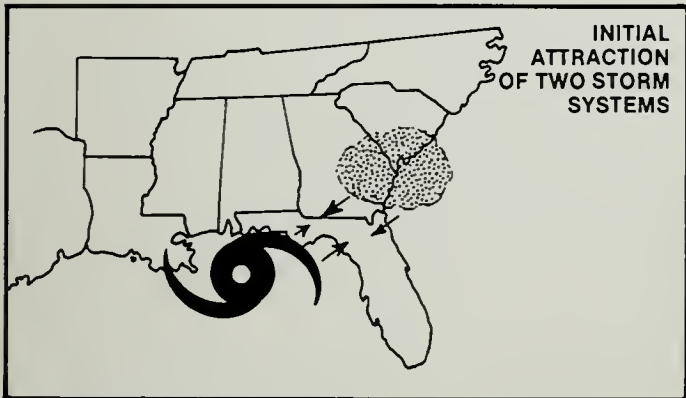

(3) Hurricane Elena continues to move towards Mobile Bay. [Storm system continues to strengthen in intensity over Georgia and South Carolina.]

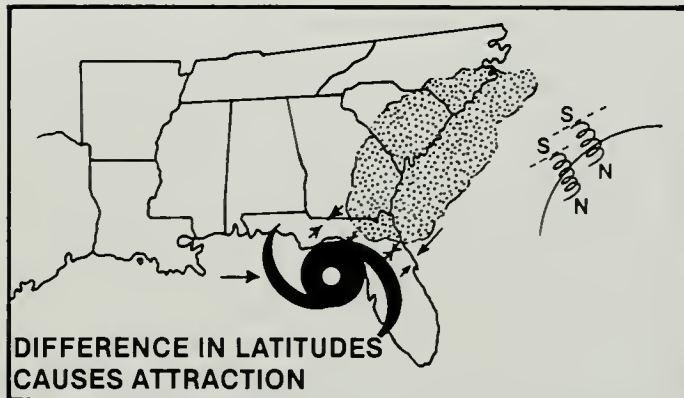

(4) Hurricane Elena moves towards FLA coast because it is electromagnetically attracted to the storm system over So. Carolina and offshore Atlantic Ocean area. The **difference** in latitude of the two storm systems causes them to electromagnetically **attract** one another.

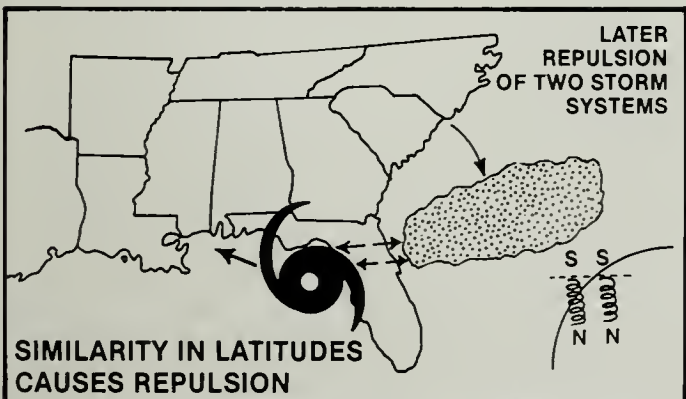

(5) The So. Carolina storm system drops towards a latitude **more equal** to that of Hurricane Elena which now stalls off the FLA coast. The **similarity** in latitudes of the two storm systems causes them to begin to electromagnetically **repel** one another.



(6) Storm system over the Atlantic Ocean now weakens and Hurricane Elena resumes its earlier northwestward course towards the Mississippi Gulf Coast area.

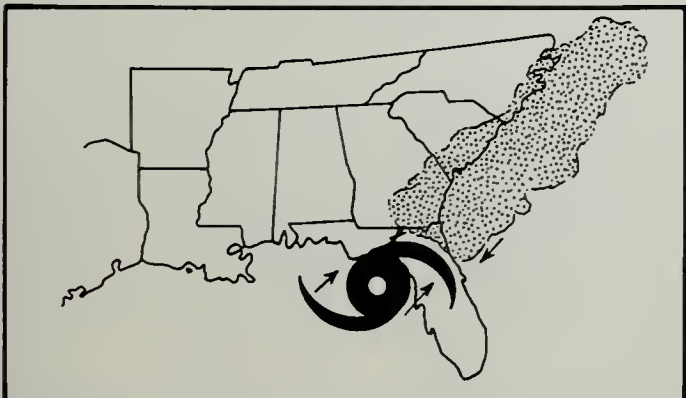

(A) Infrared light depicts Hurricane Elena electromagnetically coupled to the other storm system.

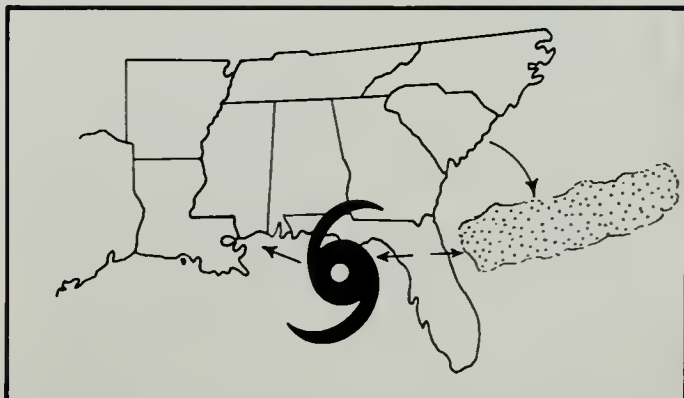

(B) Infrared light depicts the Atlantic Ocean storm system beginning to lower itself to a latitude which is closer to the latitude of Hurricane Elena. This precipitates an electromagnetic **repulsion** effect between the two storm systems.

At one point during its forward motion in the Gulf of Mexico, Hurricane Elena became electromagnetically coupled to a cloud formation having intense storm activity on its northern end. These formations were clearly depicted in photographs taken by satellites.

During the time Hurricane Elena abruptly moved towards the Florida coast, the cloud formation extended over parts of Florida, South Carolina, and North Carolina with heavy thunderstorms in the northeastern portion. At one point, a high pressure front from the northwest swung down and "pushed" the north end of the cloud formation into the Atlantic Ocean. The storm activity within the cloud formation decreased and the cloud formation became placed in a closer latitude to that of Hurricane Elena.

Just as the attraction force between the Pinwheel Cyclones becomes reduced when their respective latitudes become similar, so did the attraction between Hurricane Elena and the cloud formation become reduced as the storm activity decreased within the cloud formation. When this occurred, Hurricane Elena was easily affected by conventional air currents and assumed a northwestward course. It should be recognized, however, that such air currents are generated by electromagnetic activity as well as temperature variances.

As further evidence of the electromagnetic effect of hurricanes, I present the fact that hurricanes normally form 10° to 30° North or South of the Earth's equator.

Correlate this fact with the fact that Sunspot activity forms 5° to 35° North or South of the Sun's equator (see page 145).

This correlation proves that hurricane spin formation is not the result of the Earth's spinning upon its axis. The greatest speed of the Earth's rotation is at its equator. Yet the equatorial region of the Earth is not the breeding ground of hurricanes and is generally devoid of hurricane formation.

The regions of hurricane formation are very likely related to the plane of the Earth's magnetic equator which acts as a "block wall" (*i.e.*, low-level, electromagnetic activity) in a conventional magnet. A globe of Earth examined with respect to that magnetic axis generally correlates with the absence or presence of hurricane activity. [The Earth's magnetic equator is approximately an $11\frac{1}{2}^{\circ}$ - 12° angle with respect to the Earth's true equator.]

I am convinced that the seemingly unpredictable movements of hurricanes are *electromagnetically* induced. Such movements are capable of being mechanically understood and accurately predicted if a proper understanding of electromagnetism is achieved by responsible meteorologists.

I urge meteorologists to take this discussion seriously. I am discussing the saving of life, property, and the reduction of mental anxiety for those individuals who have been subjected to those who meteorologically cry "wolf" when there is no "wolf" as well as when there is no warning and the "wolf" suddenly and unexpectedly appears at their door.

We must encourage professional meteorologists to

study an abbreviated, basic, electrical engineering course and to "Master" what I have taught. This knowledge, combined with conventional meteorology will enable such professionals to be more confident and present more accurate instructions to those whose life and property may depend upon correct meteorological data.

But as I have taught in this book, I have no doubt that in future years, the weather will be created and controlled at will!

III. SUPER-CONDUCTING MATERIALS/CRYOGENIC MAGNETS (see page 53)

It has been recommended that I present an extended discussion concerning super-conducting materials and cryogenic magnets. The following discussion of super-conducting designs is from a Declaration submitted to the U.S. Patent Office on April 8, 1982:

“By way of example as to how someone skilled in an art may proceed in a way in which these examiners may not be skilled, applicant will turn to the art of cyrogenic temperature.

Applicant will demonstrate how easily someone skilled in the art of cryogenics, once *mastering the teachings of his invention*, could easily put forth another embodiment of his invention; but which would still be following applicant's earnest and detailed teachings and instructions relative to the Specification of his extremely pioneering invention. However, it would not be obvious to those not skilled in effects of cryogenic temperatures.

By way of example:

Find attached copies of test results (Exhibit A) by other scientists, that when coupled with applicant's teachings and disclosures, proves the above device will work— if indeed niobium tin alloy instantly becomes a formidable magnet when immersed in liquid helium and also instantly bereft of its potency when pulled from its icy bath as these other scientists state happens. Applicant is taking their word this result does happen, because he has not run the test himself.

This embodiment would work efficiently in Space, because you have extreme temperature differences relative to one side of an object facing the sun and the opposite side protected from the sun.

You will note, this energy release (Magnetic field) from the atoms of a mass in this case, are the result of a decrease of energy in the mass, and that the disappearance of that energy release (Magnetic field) from that mass, is the result of increased energy input into that mass. See pages DD19 through DD20 of the Scientific Document.

The lack of mechanical understanding of a magnetic field, atoms, and matter is exemplified by the attached pictures (Exhibit A) showing the technician holding a 3 1/2 pound Stillson wrench, which is being attracted by a cryogenic magnet at the elite Avco-Everett Laboratories. The *lack of understanding* and the amazement, excitement, and curiosity are mirrored in the *Technician's Eyes* for all of posterity to see.

Contrary to this, the detailed mechanical understanding and teachings of applicant's Specification are exemplified within the vast disclosures for all of posterity to see.

As applicant has already taught and disclosed in great detail in the patent application and its important scientific document, random atom motion slows down in materials placed in liquid helium because of temperature decrease and result in atom alignment occurring—thereby releasing their electromagnetic makeup in accordance with $E = MC^2$. See pages DD19 through page DD21 of scientific document! Also see first paragraph of Abstract of the Disclosure of patent application on page 1, and all of pages 6 and 7, and first two lines of page 17 of patent application. Also see lines 16 through 26 of page 29 of patent application. Also see lines 20 through 33 of page 35 and all of page 36 of patent application.

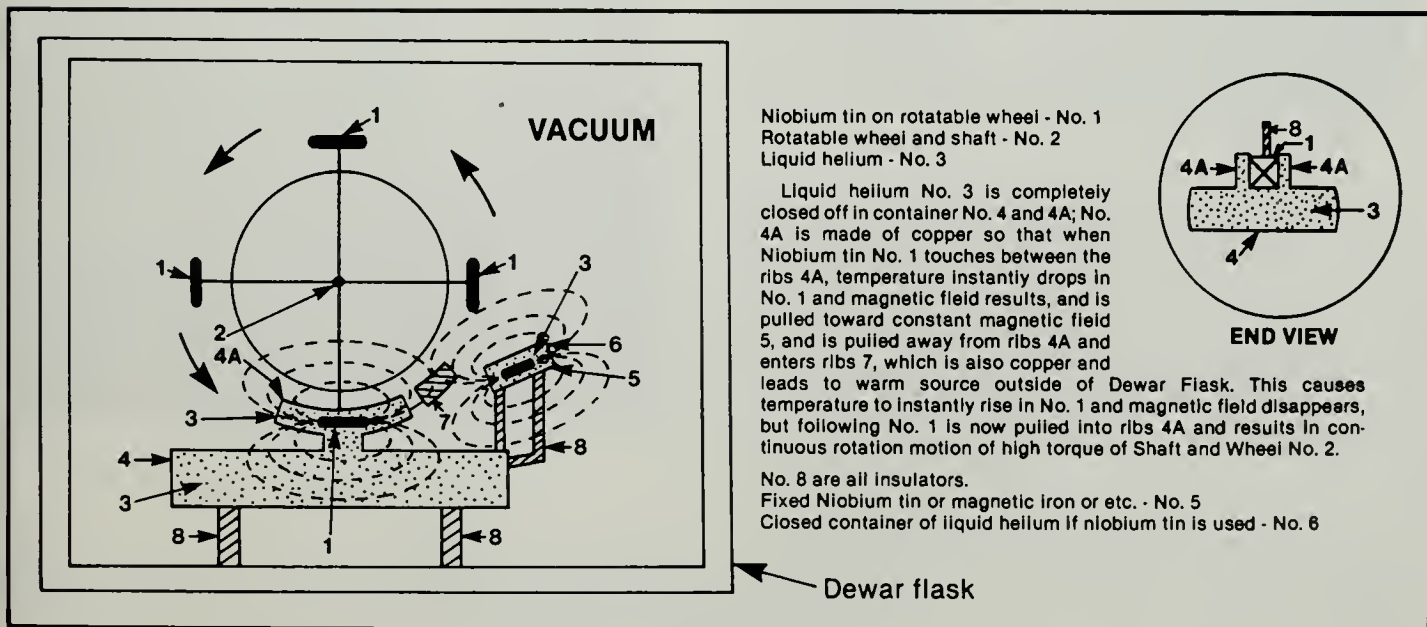

In the above drawing, the atoms of niobium tin No. 1 instantly align when touching ribs No. 4A of liquid helium No. 3 of closed top container No. 4 and 4A, thereby releasing a magnetic field ($E = MC^2$), which then interacts and attracts with the magnetic field coming from fixed magnetic field mass No. 5 (again, $E = MC^2$); therefore, the gyroscopic particles of the two separate magnetic field masses attract together as explained in great detail in the Disclosure Document. See pages DD23 through DD24.

However, the atoms of niobium tin No. 1 immediately disorientate when attracted out of ribs 4A of liquid helium and pulled into warm ribs No. 7 causing its magnetic field to disappear; but now the following No. 1 is now pulled into ribs 4A of liquid helium and the technical process then instantly occurs again: thereby a continuous, fast and strong rotation of Wheel and Shaft No. 2 will result because of the continuous flipping of alignment and non-alignment of the atoms ($E = MC^2$) of the niobium tin units attached to outer edge of rotatable wheel and shaft No. 2. This design can easily be adapted to Space, where extreme temperature differences can easily be maintained.

This is very similar to the effects of atom flipping and causing atom alignment and non-alignment in Figures 5 and 6 of the Third Embodiment already explained in detail as an example of the Technical Process which applicant has earnestly and dedicatedly taught and disclosed in great mechanical detail in the patent application and its important scientific document. In both cases, energy input into a mass is alternated, as to direction or amount.

This *obvious embodiment* is still only another example of the Technical Process which applicant has already taught. 'That the energy in a magnetic field is the energy that makes up the atoms of the material from which the magnetic field comes, and that it is literally Einstein's equation of $E = MC^2$ and therefore the energy moves at C.' That if you can cause the atoms of a material to align and disalign at your will, $E = MC^2$ will be released at your will. But how is this done? Simple — by varying mechanical means of causing atom alignment: applying or not applying pressure, force, or heat, or electrical or magnetic input, or by decreasing or increasing normal atom random motion or atom alignment. By varying or reversing those mechanical steps, the magnetic field coming from a Mass will exist or not exist or reverse direction.

Also, by means of applying the proper force at the proper angle to the gyroscopic type energy particles moving in a magnetic field, $E = MC^2$ will be released at will.

The point is — while these cryogenic results would not be obvious to an examiner not skilled in cryogenics, these results would be obvious to those who were skilled in cryogenics and mastered the applicant's Specification! Applicant is sure that there are already other materials and experiments now existing in exotic labs, that he does not know about, but which will be obvious to others so skilled; that those materials and experiments will be easily applicable to the vastness of what applicant has so earnestly taught and disclosed, once applicant's teachings and disclosures are mastered by those so skilled.

Applicant has taught a diligent, wide, Mechanical, and Technical Process of releasing energy from Mass or a Magnetic Field. Applicant has even taught the incorrectness of prior teachings: from the teachings concerning Work, Force and Power, to the Three Laws of Thermodynamics, to the teachings that a magnetic field represents only potential work and no kinetic work, to the 'whys' of conventional electrical production, and to the 'whys' of gravity and the motions of planets and stars. Applicant has mechanically explained matter, inertia, heat, magnetic fields, electricity, and much more — all of which has been always directed toward a single goal of releasing a new source of energy from Matter by a Technical Process which he could teach to others and for the well-being of all generations to come.

Applicant has indeed taught a diligent, wide, Mechanical, and Technical Process of releasing energy from a Mass or a Magnetic Field. This has been earnestly taught in the Specification and its important scientific document of the patent application of applicant's extremely pioneering invention.

The sincere effort of applicant is in the file wrapper for all of posterity to see and to judge. Therefore, in accordance with the Supreme Court's prior actions and the intent of Congress, and as an assured incentive for future inventors, applicant feels he is most certainly entitled to very broad coverage and interpretation of the genius and labors of his many years of diligent work, which will so greatly benefit his fellow human beings.

The undersigned further declares that all statements made herein of the undersigned's own knowledge are true and that all statements made on information and belief are believed to be true; and, further, that these statements were made with the knowledge that willful false statements and the like so made are punishable by fine or imprisonment, or both, under Section 1001 Title 18 of the United States Code and that such willful false statements may jeopardize the validity of the application or document or any registration thereon."

7 April 1982

Joseph Westley Newman

It isn't necessary to have current traveling into the design because whenever the coil becomes superconducting it will instantly have current induced into it by the stationary, cryogenic magnet.



EXHIBIT A (THREE PHOTOGRAPHS)

"COLD" MAGNETIC STRENGTH

In the left photograph, Bell Laboratory physicists are about to immerse a small cylinder of niobium-tin alloy in liquid helium, causing the cylinder to become a formidable magnet with a strength of 24,000 gauss. Although an excellent metal for superconducting magnets, niobium-tin becomes instantly bereft of its potency when pulled from the icy bath.

221 PAPER CLIPS IN A MAGNETIC FIELD

In the photograph below, a single magnet demonstrates a considerable magnetic field when placed inside a Dewar flask of liquid helium at the Avco-Everett Laboratories in Everett, Massachusetts. [Each metal paper clip hangs freely from a tack upon the board.]

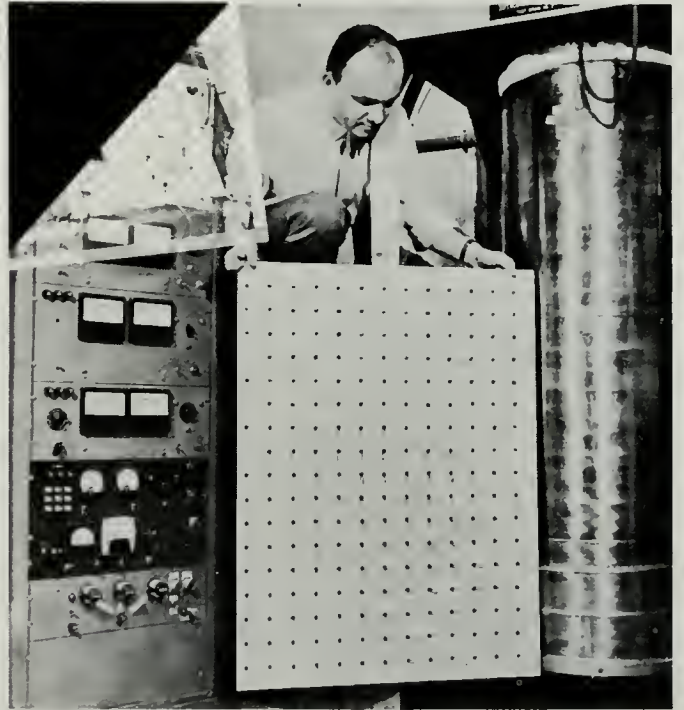

MAGNET VS. MAN

In the left photograph, the same magnet used with the 221 paper clips now demonstrates its pull upon a 3½-pound monkey wrench. The pull upon the wrench is so great that a grimacing technician exerts his pull upon the cord tied to the handle of the wrench to prevent it from clanking against the Dewar flask. Such magnets exert their considerable pull without the assistance of a single watt of electricity.

The reader can clearly see that the expression on the face of the technician holding the Stillson wrench at a right angle to the cryogenic magnet, *says it all!*

The cryogenic magnet demonstration clearly proves the following to the questioning mind:

The produced magnetic field originates from the atoms of the conductor. However, the field originates from the atoms of a super conductor and not from the current inputed into the superconductor!

IV. MAGNETIC MOTOR/PUMP

I have also developed a reciprocating magnetic motor whose design is based upon the same principles which I have disclosed in this book. Refer to photograph 15-C2 on page 36. My reciprocating magnetic motor has a different mechanical design from the energy machine pictured in 15-C2 since a cylindrical magnet has been placed *inside* the coil in order to generate a reciprocating motion.

In this new configuration, the electricity is taken off the magnets themselves via (1) one conductor through a load to ground, (2) one wire taken off one terminal of the battery through a load to ground, and (3) a load hooked across the coil itself. In addition to the electrical output of the system, one must also consider the reciprocating workload of the magnets themselves.

This design could be a magnetic pump in which the permanent magnet is both a motor piston and pump piston capable of pumping numerous types of fluids for commercial production and simultaneously generating electricity for commercial utilization!

V. ELIMINATION OF UNDESIRABLE COMMUTATOR SPARKING

I refer the reader to my discussion of undesirable commutator sparking and air ionization on page 69, left column, second paragraph, which starts with the heading "EXAMPLE OF ANOTHER DESIGN."

Since the First Edition was published, I have innovated an advanced design which will eliminate the damaging sparking effects of the earlier commutator designs.

speed of atom unalignment and releases greater energy output with respect to energy input. (With increased hydraulic pressure [voltage], the commutator discs should be further increased in number.)

The following is a commutator example for a reciprocating motor design:

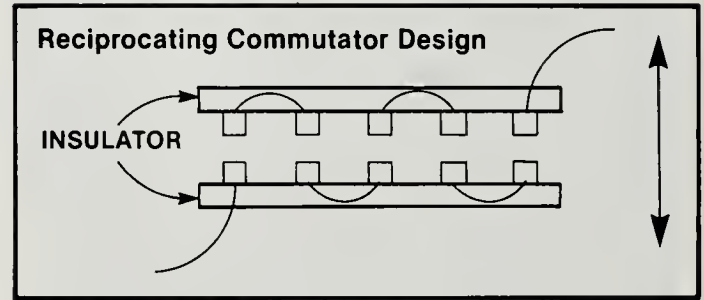

In terms of reducing spark severity for a given coil at the GAP separating the brush and commutator, tests have demonstrated to my satisfaction that there is a mathematical relationship between the hydraulic pressure (voltage) and the number of times the hydraulic pressure (voltage) must be "broken" by mechanical or other switching mechanisms. Such additional "breaks" increase the overall distance the spark travels in a given instant of time while distributing this distance over a greater number of individual but smaller GAPS.

I have no doubt that the above designs will facilitate rapid production of commercial units. With such commutator designs utilizing approximately 100 firing "breaks," one can easily increase the hydraulic pressure to 100,000 volts (or greater) with a properly insulated

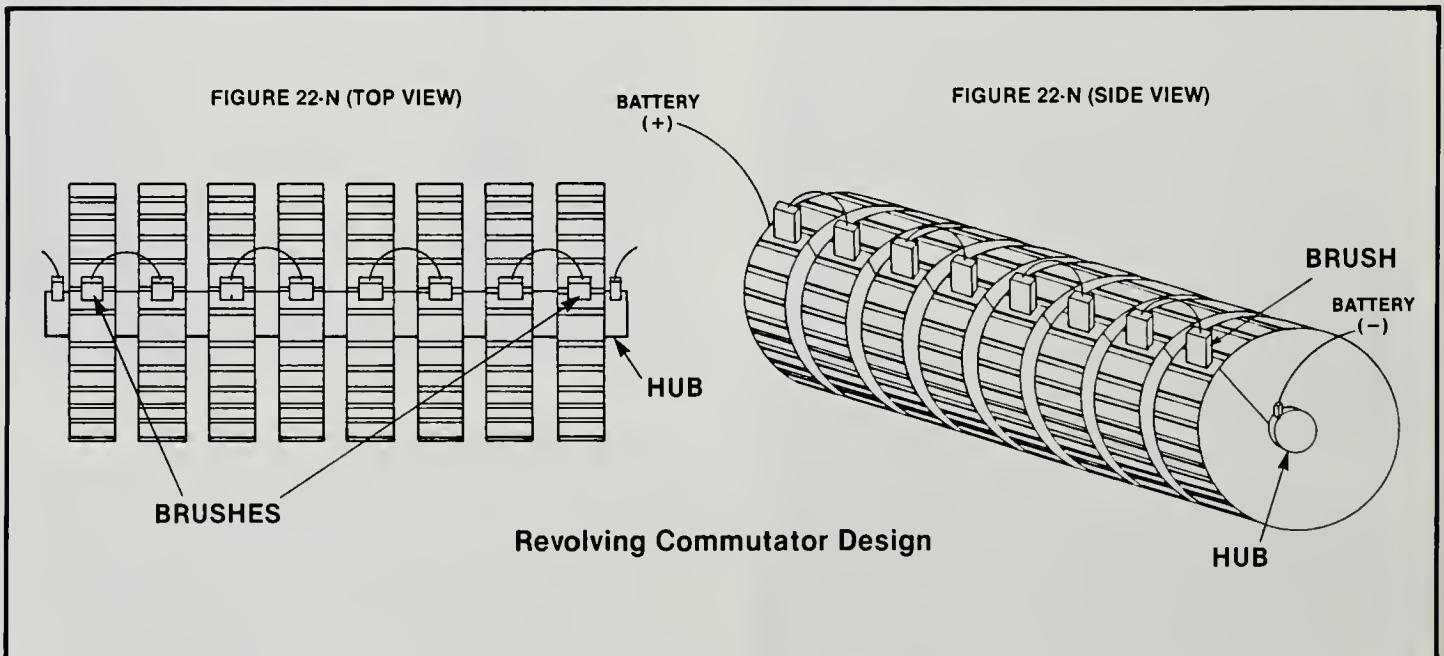

In Figure 22-N the commutator and brushes can simply be multiplied two or three times over the original commutator as depicted in the commutator photographs on page 64. The commutator pictured in Figure 22-N has eight breaks and fires simultaneously such that the GAP distance the spark has to travel is multiplied by a factor of eight. Such a mechanical configuration multiplies the

coil. However, numerous energy-consuming devices would need to be connected into the system to absorb the coil's high energy production.

With such an improvement in commutator design, production units of the energy machine can be built immediately by those individuals who have mastered my teachings.!

VI. ACCEPTANCE WITHOUT RECOGNITION

It has become apparent that the "scientific community" is beginning to accept my teachings without providing recognition of the fact that I developed over twenty years ago my knowledge concerning the electromagnetic field nature of the universe. Such a lack of recognition will impede their understanding of the greater implications of my teachings.

The following are several quotations from individuals featured in an article entitled "Much Ado About Nothing" in the June 1985 issue of *DISCOVER*, pages 76-80:

"*'Now we believe that the entire universe is nothing but a field theory,' says Harvard physicist Sidney Coleman.*"

"*'Imagine that the entire universe was permeated with a constant magnetic field,' Frank Wilczek suggests. 'You would notice certain things that you couldn't explain unless you assumed the presence of the field. The Higgs field is similar to that situation. We see things — the particle masses — that we can't explain, and assuming the presence of the Higgs field explains them.' If you couldn't get rid of this mythical magnetic field, it would be part of what you had left when you took everything else away. In other words, it would be part of the structure of the vacuum.*"

"*Says (MIT physicist Alan) Guth, 'People are talking about questions that five years ago were considered outside physics.'*

The following are two quotations from an article by Eric J. Lerner entitled, "Magnetic Whirlwinds" in the July 1985 issue of *SCIENCE DIGEST*, page 26:

"*In the summer of 1984, astronomers using the VLA radio telescopes in New Mexico observed filaments of gas arcing far above the galactic plane. These twisting spirals appeared to be held together by a magnetic field, forming a magnetic whirlwind stretching across perhaps 500 light-years. The discovery, itself significant, also added to the growing evidence that such magnetic vortices play a major role in the universe — an idea given little weight until recently. As Anthony Peratt, a plasma physicist at Los Alamos National Laboratory, comments, 'It looks more and more that magnetism plays as important a part in the cosmos as gravitation.'*"

Peratt continues:

"*It looks like gravitation alone is not the whole story — it looks like it also takes magnetism to make the universe the way it is now.*"

I would hope that the reader of my book has understood the fact that the *entire* Universe represents a

gigantic electromagnetic *energy machine* composed of uncountable numbers of gyroscopic entities which mechanically interact to generate all observable phenomena.

From the evidence I have presented in this book and the extensive evidence I have contained within my files and diaries, I would also hope that the reader recognizes the fact that I have pioneered the development of these concepts over twenty years ago. If there is justice in our Universe, then I can only ask that credit be given where due. Proper credit would further stimulate not only this inventor but all future inventors for the betterment of the human race.

VII. SPACE WARPAGE

The following question has been raised: "Why isn't gravitation simply defined as the warpage of 'Space' caused by a mass simply being in that 'Space'?" In posing such a question, reference is made to Albert Einstein's view that if a heavy object is placed on an elastic plane, then the heavy object will create an indentation in the elastic plane causing any smaller objects in the larger object's vicinity to move down towards the lower indentation area.

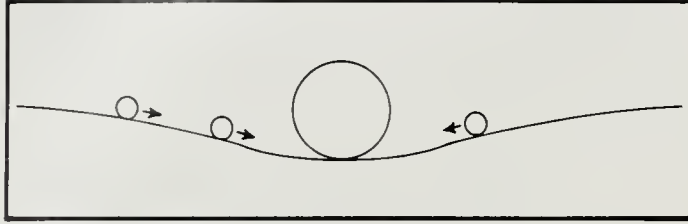

It is not surprising to this author that at the time Albert Einstein proposed such a view of space warpage to experts in the domain of Magnetism and Electrical Theory, such experts totally rejected Einstein's mechanical/pictorial space warpage hypothesis when he attempted to apply it to their area of electromagnetic theory.

However, the brain-damaging (soiling) effect of our present teaching system is corroborated by the fact that many physicists — many of whom are not mechanically inclined — have blindly accepted Einstein's *totally inaccurate and false* pictorial hypothesis of gravity. Such blind acceptance has occurred because once Einstein's thinking ability was accepted as being above that of the average scientist, such scientists unquestioningly accepted some of his beliefs which are not mechanically tenable.

The known laws of Hydraulic Mechanics demonstrate that Einstein's hypothesis of space warpage is totally wrong. I say this not to denigrate Albert Einstein, but rather to question the blind acceptance of his hypothesis by those physicists who may not be mechanically sensitive to what is actually involved in this instance.

FACT: Space surrounds an object on a 360° basis. It is simply incorrect to view Space as a place capable of being "indented."

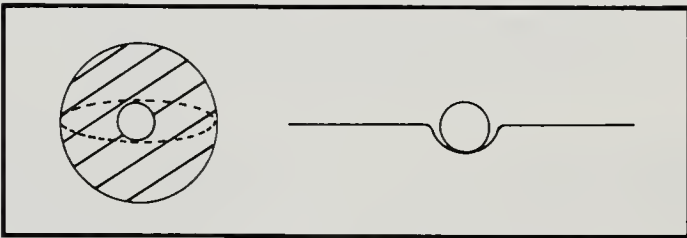

The Laws of Hydraulics state that the pressure of a medium is equal throughout a hydraulic system. Even the Archimedean Law of Buoyancy — developed over 2,000 years ago — states that if a given material (mass) is placed in a liquid (medium), it would displace an amount of liquid (medium) equal to the weight of the material (mass).

To prove that Archimedes' Theory of Buoyancy is correct and that Einstein's pictorial/mechanical explana-

tion of space warpage is incorrect, simply conduct the following test:

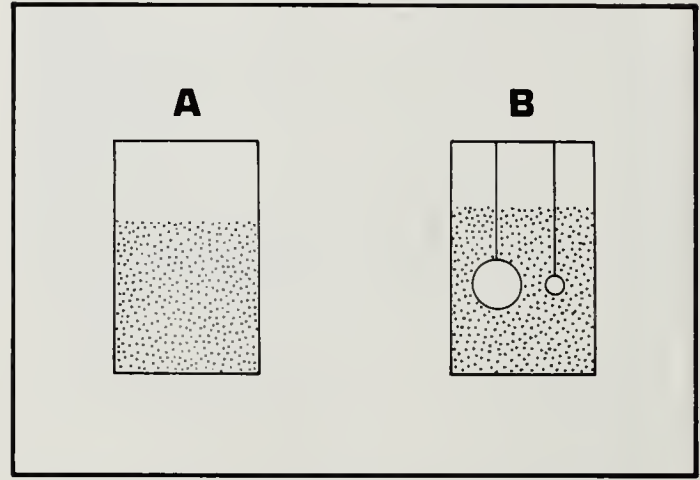

Fill two equal-sized glasses with an equal amount of liquid as shown in Figures A and B. Lower a large and a small mass into glass B. You will observe that the level of liquid has risen in glass B. However, you should also observe that the liquid equally surrounds both the large and the small mass. There will be no vacuum or indentation of empty space associated with either mass. Consequently, the smaller mass would have no mechanical tendency to move towards the larger mass, since the liquid medium (or space) surrounding the mass is equally displaced.

The identical process would apply to the medium of Space surrounding masses in Einstein's pictorial/mechanical hypothesis of space warpage — a hypothesis which is simply proven wrong by the "Facts."

Ironically, Albert Einstein was quite candid in his admission that he possessed no mechanical ability. However, many scientists who followed Einstein ignored that admission.

In proper tribute to Albert Einstein, I will state that he was mathematically correct when he said that there would be a warpage of space. However, such warpage is created by the *mechanics* of the *electromagnetic effect* that I have discussed in this book.

I have already demonstrated that one cannot bring together two electric or magnetic entities without a mechanical warpage of the electromagnetic fields (consisting of gyroscopic particles) surrounding the entities. Moreover, I have demonstrated that gravitation is simply the *unequaling effects* of this electromagnetic interaction. Consequently, Gravity, Electricity, and Magnetism consist of one and the same entity: "The mechanism of this gyroscopic entity is the essence of all matter and energy." The *observed* differences in matter and energy are a result of how we perceive the mechanical effects of the Gyroscopic Particle from the perspective of an outside observer.

VIII. IMPORTANT CONGRESSIONAL ACTION

Dear Fellow Human Being,

I thank you for reading a copy of my book. It is a statement of my learning and my life's work. For over two decades I have devoted my life to the perfection of a New Energy Source which will be of tremendous benefit to all "Peoples" of this World. If you have heard of my 6½-year struggle with the Patent Office to obtain a pioneer patent for my energy machine, then I hope you will assist me. This invention would dramatically benefit all Americans and people throughout the world by making available inexpensive and abundant energy. But your help is needed!

This Exciting Invention and all that it encompasses is for the "People" of the World: for you and yours and your children and your children's children. No, **not** for me, **for you**.

As a "reward" for my years of dedicated effort, an arm of our Government — the U.S. Patent Office — has deliberately, consistently, and with premeditation sought to serve me Injustice. This Injustice is not restricted to me, but is amplified millions of times over to you and yours, and to the "People" of the world.

The officials of the U.S. Patent Office have — to such an extreme extent — conducted themselves outside the law and the very purpose of the existence of the U.S. Patent Office, that when viewed relative to the "Facts" of this Pioneering Invention, one would assume that the U.S. Patent Office had embarked on a Documentary entitled, "**How To Stifle Creativity.**"

After bringing these facts to the attention of numerous Senators and Congressmen within the United States, one was moved enough and outraged enough that, on October 17, 1985, he introduced a Special Bill, Number **H.R. 3590** into the First Session of the 99th CONGRESS asking the Senate and House of Representatives "... acting through the Commissioner of Patents and Trademarks, shall immediately issue a pioneer patent to Joseph W. Newman for the invention described in patent application numbered 179,474 ..." No, this Congressional Representative of the "People" was not from my State of Mississippi, nor an immediate neighboring State, but rather from a far Northern State of the United States — the State of Indiana — more than 600 miles from my home in Mississippi, a far Southern State of the United States.

The "Facts" show that this Bill is not only a *special bill*, but that the man who introduced it must be a *special human* and elected Representative of the "People." That *special individual* is **Congressman Dan Burton!** Congressman Dan Burton is not only speaking for me, but for you and yours. This effort towards Justice goes way beyond the mere Joe Newman; it concerns Justice to Creative Individuals and the "People" who are the recipients of the value generated by those Creative Individuals as yet unborn. Hopefully, the Special Effort of Congressman Dan Burton will result, not only in a Pioneering Patent to me, but also in **Patent Law Changes** that will act as a Bright Shining Light, to eternally illuminate all actions taken by Patent Office Personnel. Such Patent Office Personnel are, in reality, the *Custodians* of the stimulation of the "Jewel" of our civilization — its "Creative People" — and thereby should never be allowed to stifle this priceless benefactor.

If you agree with what I have to say, are persuaded by what I've said, if you want to help right the wrongs done by the Patent Office and want to help protect my work and thereby give hope and protection to others — you can.

Congressman Dan Burton is only one individual, but only a *few* members of committees or subcommittees will really decide whether I get a patent. Please care enough to let Congressman Dan Burton know you appreciate the fact that he is and must be a *special individual*. Congressman Dan Burton is proof that you count in Congress. Call and write your Congressmen and Senators and ask them to diligently support Congressman Dan Burton's Bill, Number **H.R. 3590**, pending at this time before the 35 members of the House Judiciary Committee. If you have a close friend or relative in another state, call or write them and ask them to contact their respective Senators and Congressmen on this issue.

You compliment yourself, the Human Race, and the Future by so acting.

Thank you, the "People."

Joseph Westley Newman

IX. ADDITIONAL PROOF — NOT CONTRADICTION OF MY WORK

[This section has been added to the Third Edition.]

Several readers have asked me about the article published in the January 6, 1986 issue of Physical Review Letters which presents the opinion of several scientists who have announced the discovery of a "previously unknown force in nature called the hypercharge" and their conclusion that "it also requires a modification of our theories of gravitation." Their evidence indicates that there will be minute variances in the speed of different objects falling toward Earth when such objects are placed in a vacuum.

In response to the above "discovery," I simply quote from the last two paragraphs of page 9 and the first paragraph of page 10 of my Disclosure Document sent to the U.S. Patent Office in 1979 and to the U.S. Copyright Office.

"The Earth consists of innumerable other negative and positive charges and is either slightly more negative or positive.

"There can be an infinite mathematical arrangement, whereby, materials will vary *as will their attraction toward Earth*. (Emphasis added.)

"Consider now the fact that in 1974 I wrote to the National Science Foundation stating the prediction that the Cavendish Experiment conclusions were wrong. *I had no doubt that if the experiment was sensitive enough, there would be different results for different materials used.*" (Emphasis added.)

Refer to page 197 of this book for the response from the National Science Foundation in 1974 which offered a response to my statement to them that even the "speed and path of objects in their orbits" would be affected.

Also, read from Section 29-I on page 93 to Section 29-K on page 94 of this book and read the proof that matter consists of unequal negative and positive charges. This is the reason that years ago I had predicted minute differences in Gravitational Force (the unequating effect of Unobvious Electromagnetic Composition of matter consisting of different amounts of negative and positive charges.)

This effect is principally of scientific interest, rather than for practical mathematical calculations of accelerating or stopping a mass or masses.

However, I compliment the scientists mentioned in the Physical Review Letter article for their astute observations and conclusions that there are indeed differences.

The reasons for these observed minute differences are the result of the Electromagnetic Composition of All Matter. Such composition will provide many varying results to the outside observer.

We stand at the gateway to great excitement and advancement for the Human Species.

[The following sections have been added to the Fourth Edition.]

X. UTILIZING PRESENT MATHEMATICS TO PROVE AN IMPORTANT NEW ANALYSIS

[or, to express it colloquially, "The steel wedge of *truth* hit by the sledgehammer of *facts* will break open closed minds."]

The scientific community's *own* "mathematical equations" prove the validity of what I mechanically teach: "The energy in a magnetic field associated with the current in a conductor *emanates from the ATOMS of the conductor and NOT from the current.*"

The present teaching system indoctrinates students with the following premise: students are taught that "a copper wire is non-magnetic and that the magnetic field emanates from the current and not from the conductor." Moreover, students are taught that "the conductor simply carries the current, as a water pipe carries water." (See Figures 14-B5 and 15-B6.) Refer to page 15 of this book for further detail.

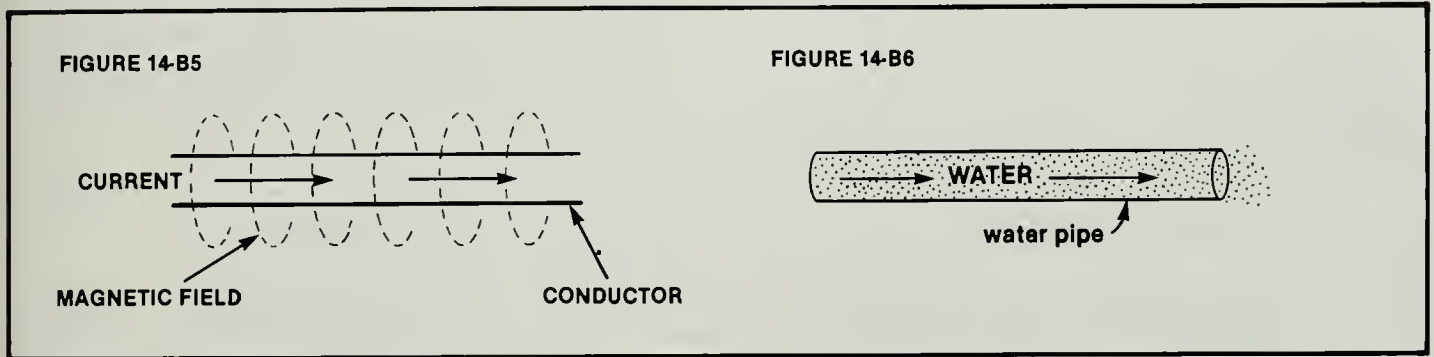

After the student has accepted the false premise described above, the student is then instructed (by "sleight of hand") that, if a current-carrying conductor is *coiled* rather than *straight*, (See Figures 14-B7 and 14-B8) —

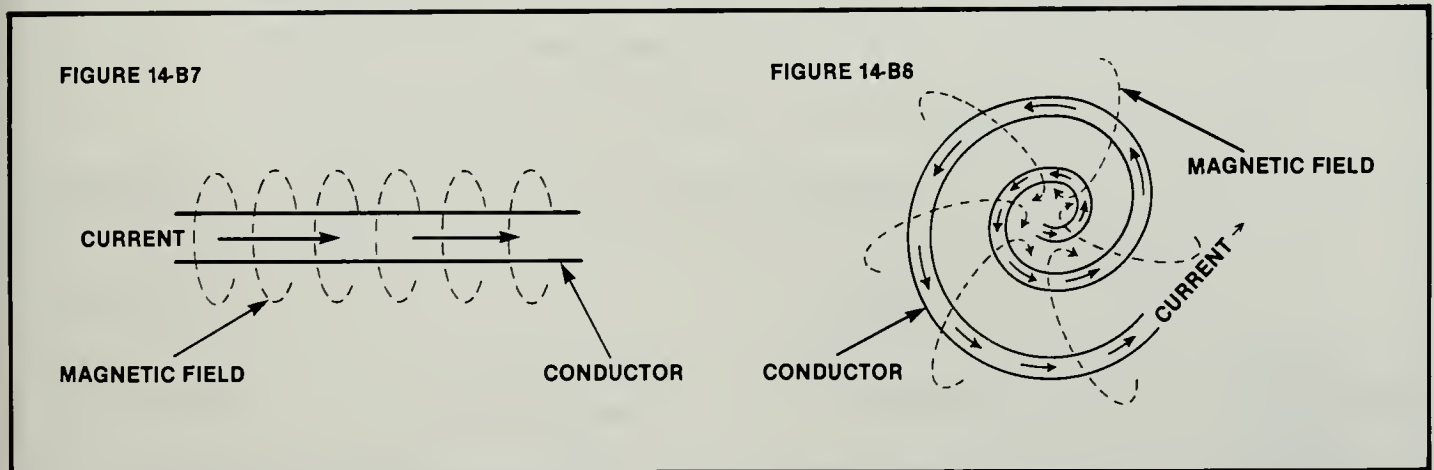

then the current and its associated magnetic field are concentrated, which results in a concentration of the strength of the magnetic field. The student is then provided with the following statement:

"The strength of the magnetic field equals the current times the turns of the conductor" (also called amp turns).

The above two underlined statements concerning the origin of a magnetic field vis-a-vis a current/conductor **are not the same!** In fact, these two statements contradict one another!

QUESTION: What comprises a conductor?

ANSWER: Atoms, of course.

What the statement "the strength of the magnetic field equals the current times the number of turns of the con-

ductor" *really* means is that "the strength of a magnetic field of a coiled conductor equals the input current times the number of 'turns of ATOMS' which comprise the coil." [Refer to Chapter 8, beginning with page 49 for further detail.]

For those who have been "mentally lobotomized" by the effects of our present unjust teaching system, I refer them to pages 238-242 of this book.

The only issue of fact is whether the current or the atoms of the conductor produce the associated magnetic field. No other deception or excuse — e.g., time of the magnetic field's expansion, changing resistance of the coil turns due to the changing diameter of the coil as more coils are added, etc. — has absolutely any scientific merit or bearing upon the truth and validity of the facts presented in this discussion.

Then there are those who blindly state that the cur-

rent in the longer coil produces a magnetic field identical to that of the shorter coil. The facts prove such people totally wrong! [The currents are not the same.]

The following *facts* and graphs prove that 1 amp of current must be maintained in the "atoms" of one turn of the conductor to sustain a magnetic field of strength Z. And 10 watts of power must be maintained to sustain that magnetic field of strength Z. [1 amp x 10 volts = 10 watts]

At the opposite end of the mathematical spectrum, a miniscule .000000000000001 amp has to be maintained in 100,000,000,000,000 turns of the atoms comprising the conductor to sustain the same magnetic field of strength Z. In this case, a miniscule 1/10,000,000,000,000 of a watt of power must be maintained to sustain the same magnetic field of strength Z.

In other words, the fact that the input current and the number of atoms (turns of wire) can vary tremendously with respect to one another while the **same magnetic**

field is sustained in all cases — proves that this resultant magnetic field emanates from the atoms of the conductor and is **not** produced by the input current.

The following drawings, explanations, and graphs which utilize mathematically-accurate, scientific *facts* will "cement" the truth of what I teach: The magnetic field associated with a conductor-carrying current originates from the atoms of the conductor and *not* the current. **The current is simply the medium which transfers the hydraulic pressure of the volts and causes this hydraulic pressure to align the atoms of the conductor.** Under such hydraulic pressure (voltage), the aligned atoms release their gyroscopic particles — the basic building blocks of all matter — which emanate beyond the physical boundary of the conductor and behave exactly as a permanent magnet. (Refer to Figures 14-B9a/b and 14-B10a/b.)

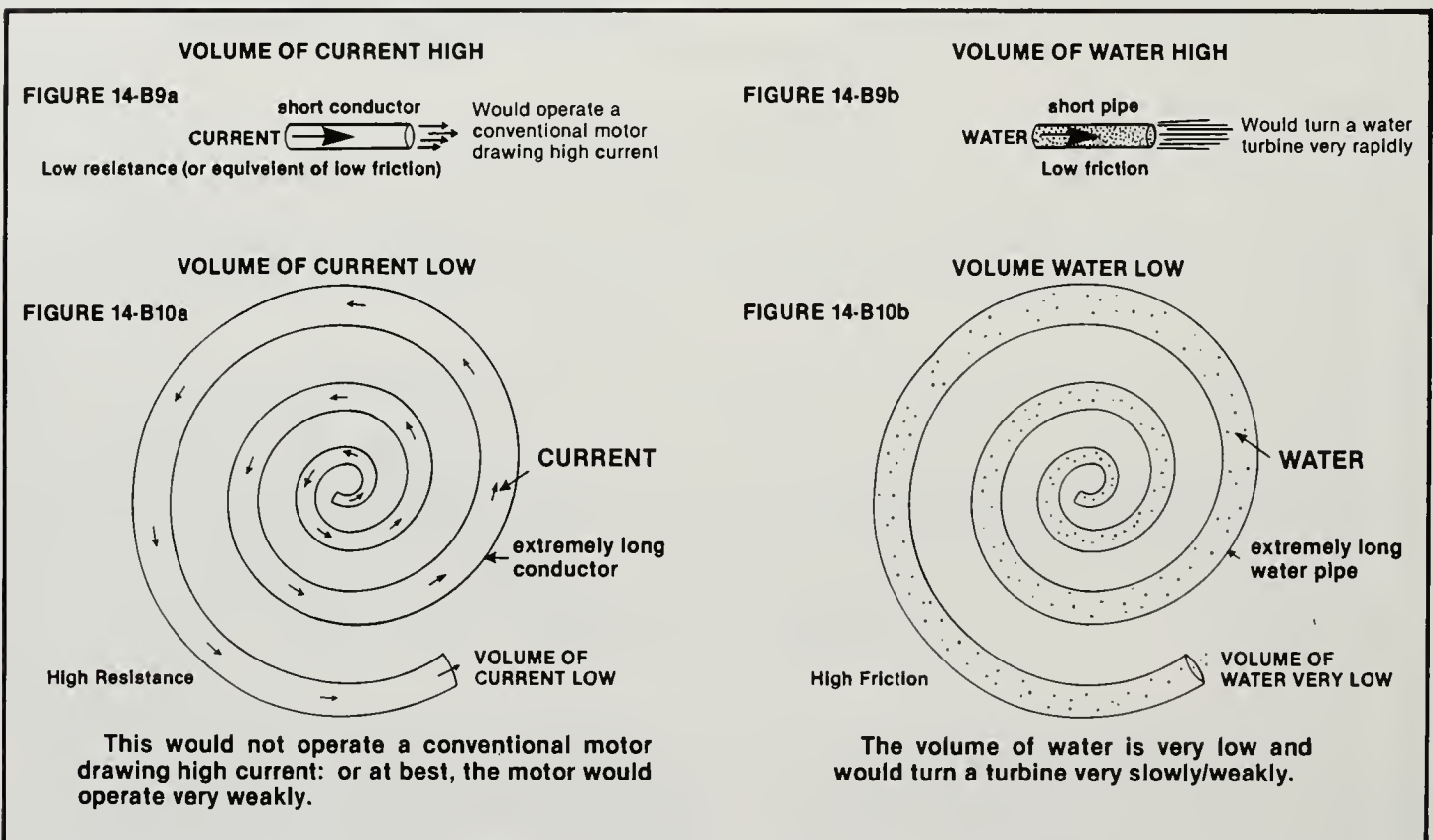

Even the basic premise proposed by the present scientific community — "a moving charge produces a magnetic field and a stationary charge does not" — demonstrates their conclusion to be incorrect as discussed here. Because if the charge produces no magnetic field when stationary, and then produces a magnetic field when moved, it would then seem only logical that the faster the charge moved — the greater the magnetic field, and the slower the charge moved — the weaker the magnetic field.

The mechanical facts demonstrate in Figures 14-B9a and 14-B9b that a given charge will quickly exit from the end of a conductor exactly as a molecule of water from a short pipe.

The mechanical facts demonstrate in Figures 14-B10a and 14-B10b that a given charge would, by some degree, move slowly and exit from the end of an extremely long conductor exactly as a molecule of water from an extremely long water pipe.

Therefore, such mechanical analogies would have one believe that the magnetic field associated with the conductor in Figure 14-B10a would be very weak, and the magnetic field associated with the conductor in Figure 14-B9a would be very strong.

The facts prove these magnetic fields are equal!

No deceptive or prejudiced comment will alter the fact that in Figure 14-B9a a large volume of current and power input is necessary to sustain a magnetic field of strength Z. In Figure 14-B10a, only a miniscule volume of current and power input is necessary to sustain a magnetic field of strength Z.

The facts clearly prove that the magnetic field Z associated with a conductor is not a result of the current or power input into the conductor, but rather is the result of the number of atoms which comprise the turns of the conductor. This underscores the fact that the magnetic field comes from the atoms of the conductor and not from the current.

Those individuals who are not afraid to think for themselves will quickly see the truth of these facts.

Those individuals who have been unjustly and

seriously affected by the present teaching system will uncomfortably feel that they must resist these facts.

The following mathematics, based upon the teachings of the present scientific community, proves "mathematically" that what I have consistently taught "mechanically" is absolutely correct.

Remember — the following mathematical results are provided by the present scientific community and **not** by me. The present scientific community states that a magnetic field of a given strength is achieved by the amount of current multiplied by the number of turns of a conductor. Consequently, the following mathematical results are presented for your consideration:

Using a 10-Volt battery the following results occur —

$$(\text{volts} \times \text{current} = \text{watts})$$

$$1 \text{ amp} \times 1 \text{ conductor turn} = 1 \text{ amp turn [i.e., } 1 \text{ amp} \times 10 \text{ volts} = 10 \text{ watts]}$$

$$100 \text{ M.A. (or } .1 \text{ amp)} \times 10 \text{ conductor turns (CT's)} = 1 \text{ amp turn [i.e., } .1 \text{ amp} \times 10 \text{ volts} = 1 \text{ watt]}$$

$$10 \text{ M.A. (or } .01 \text{ amp)} \times 100 \text{ CT's} = 1 \text{ amp turn [i.e., } .01 \text{ amp} \times 10 \text{ volts} = 1/10 \text{ of a watt]}$$

$$1 \text{ M.A. (or } .001 \text{ amp)} \times 1,000 \text{ CT's} = 1 \text{ amp turn [i.e., } .001 \text{ amp} \times 10 \text{ volts} = 1/100 \text{ of a watt]}$$

$$.1 \text{ M.A. (or } .0001 \text{ amp)} \times 10,000 \text{ CT's} = 1 \text{ amp turn [i.e., } .0001 \text{ amp} \times 10 \text{ volts} = 1/1,000 \text{ of a watt]}$$

$$.01 \text{ M.A. (or } .00001 \text{ amp)} \times 100,000 \text{ CT's} = 1 \text{ amp turn [i.e., } .00001 \text{ amp} \times 10 \text{ volts} = 1/10,000 \text{ of a watt]}$$

— additional intermediate steps not listed —

$$.00000000001 \text{ M.A. (or } .0000000000001 \text{ amp)} \times 100,000,000,000 = 1 \text{ amp turn}$$

$$[\text{i.e., } .0000000000001 \text{ amp} \times 10 \text{ volts} = 1/10,000,000,000,000 \text{ of a watt}]$$

FIGURE 14-B11

GRAPH OF THE ABOVE MATHEMATICS:

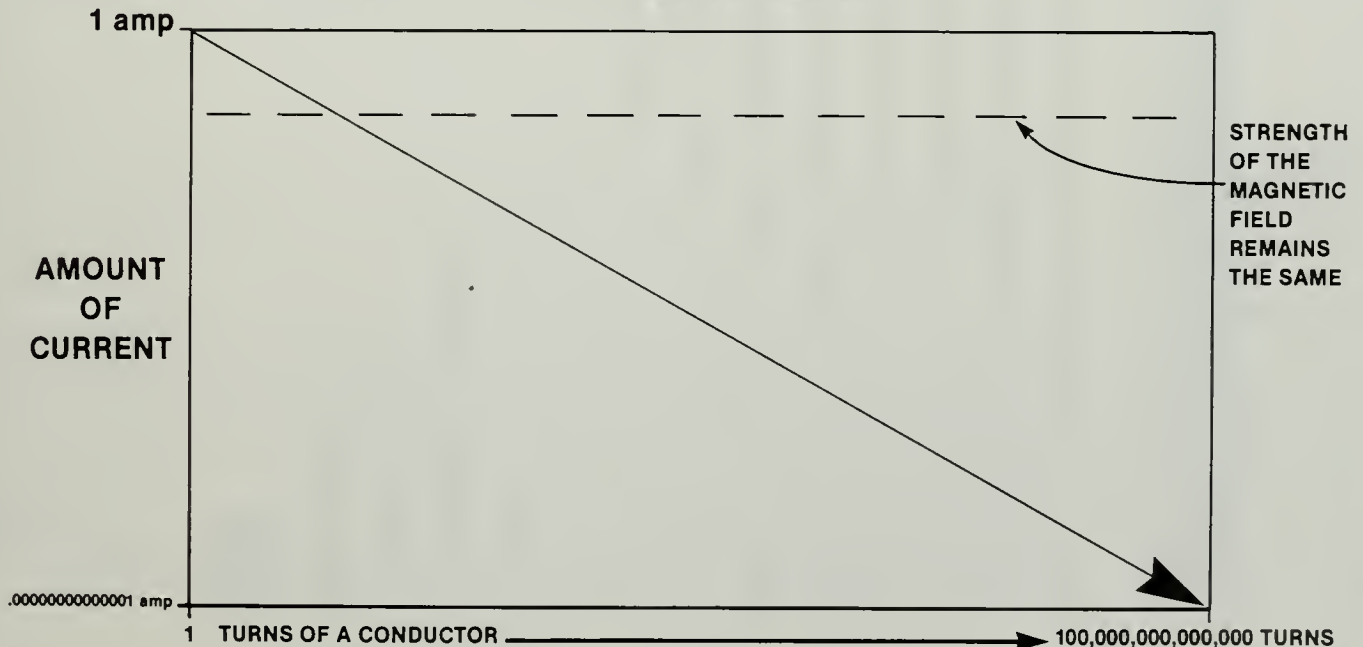

The mathematical facts and graph described above prove that the amount of current has consistently decreased while the strength of the magnetic field has remained constant as a result of a consistent increase in the

number of "turns of atoms" comprising the conductor.

These scientific and mathematical facts prove that what I have consistently taught mechanically is correct. These facts also prove that the magnetic field associated

with a current-carrying conductor emanates from the atoms of the conductor and not from the current which consistently diminishes. Such a current could reach an infinitesimally small number while the conductor would produce an infinitely large magnetic field. [Refer to Chapter 8, page 49 of this book for additional details.]

Let's now consider the relationship between Faraday's Laws of EMF (electromotive force) induction and the strength of the magnetic field as it expands or collapses through an increasingly larger number of turns of wire (atoms). When one considers the graph in Figure 14-B11 and Faraday's Laws of EMF induction, one finds *mathematical proof* of the following:

As a consistently-*decreasing* current is inputted into a consistently-*increasing* number of turns of conductor-coil wire (atoms), the produced magnetic field remains constant. Even more important is the fact that whenever the input current is stopped, one produces an ever-greater back EMF from the collapsing magnetic field through an ever-*increasing* number of turns of atoms comprising the conductor — this occurs with an ever-*decreasing* current input.

These mathematical facts verify my teaching that the power from a conductor can be greater than the power inputted into the conductor! (Refer to page 51 of this book for additional details.)

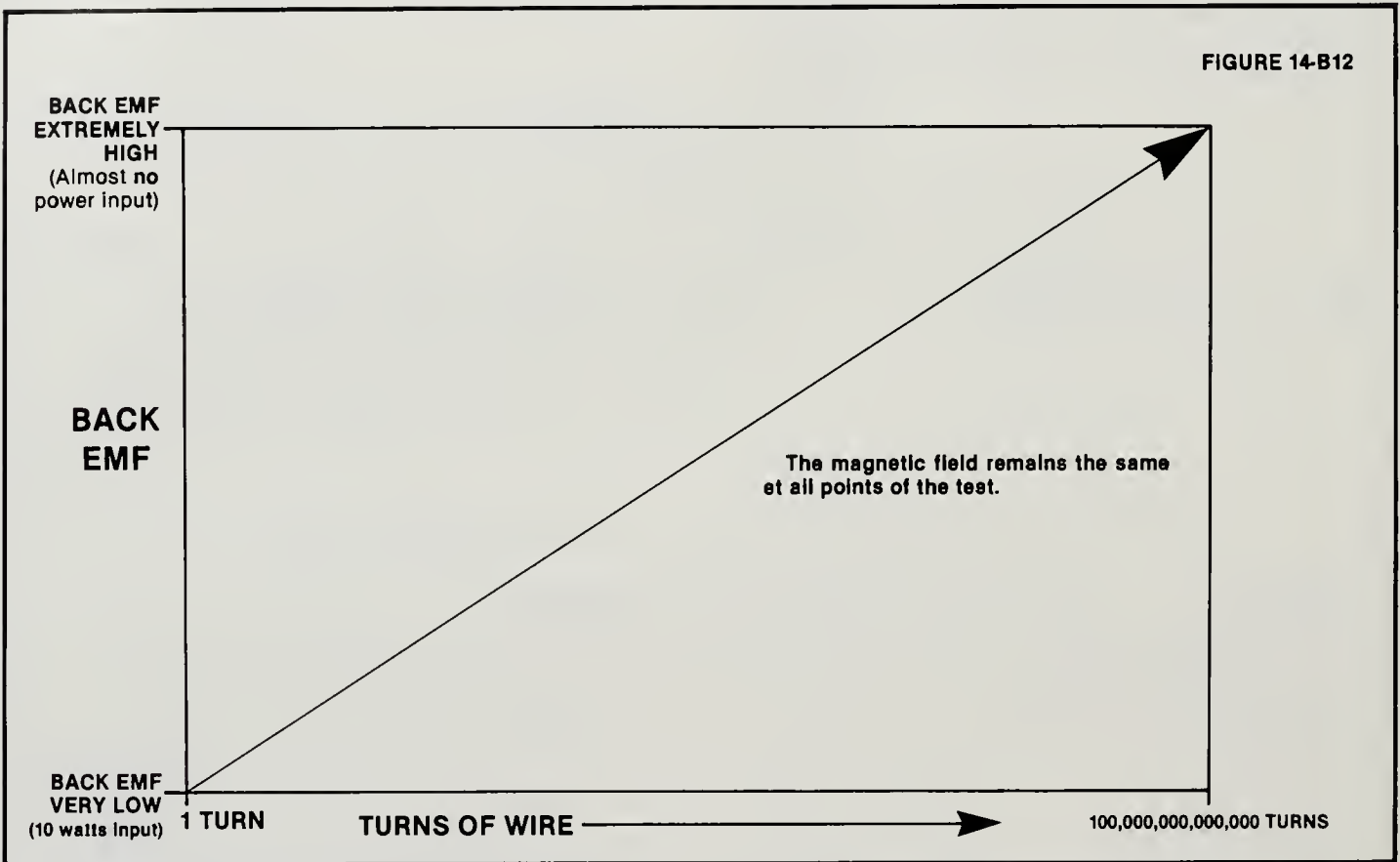

To rephrase the colloquial title of this section: "The sledge hammer of *facts* has now hit the steel wedge of *truth* even into closed minds."

The mathematics I have presented in this section are from materials published by the present scientific community. These mathematics are not original to me. I have simply but precisely combined my mind with their mathematics in an exacting logic whereby the consistent mechanical teachings I have developed are proven mathematically correct.

The energy in a magnetic (electromagnetic) field is literally the mechanical essence of $E = MC^2$. This energy can be mechanically understood, anticipated, utilized, and released at will to generate the tremendous release of energy without any harmful effects to humanity and to the environment.

Tremendous excitement, hope, dreams and accomplishments will quickly ensue from what I teach since no aspect of science will remain unaffected by these concepts. A magnificent future lies at the "fingertips of our imagination" because the entire universe reacts electromagnetically and has a fundamental electromagnetic composition which can be harnessed to benefit humanity.

PRIOR (CONVENTIONAL) TEACHINGS STATE THAT THE MAGNETIC FIELD COMES FROM THE CURRENT AND NOT THE CONDUCTOR. BY THIS REASONING, IF ONE WANTS MORE POWER FROM A MOTOR, ONE DESIGNS IT TO USE MORE CURRENT. [EXAMPLE: THE CONVENTIONAL FAN DRAWS OVER 100 TIMES MORE CURRENT THAN THE FAN POWERED BY THE NEWMAN ENERGY MACHINE.]

IN PRIOR DEMONSTRATIONS OF THE CONVENTIONAL FAN VS. THE NEWMAN-MOTOR-POWERED FAN (BOTH FANS RUNNING AT THE SAME RPM), THE CONVENTIONAL FAN DREW 16 WATTS; THE FAN POWERED BY THE NEWMAN ENERGY MACHINE DREW APR. 2.6 WATTS — AND APR. 6 TIMES MORE CURRENT IS GOING BACK INTO THE BATTERY THAN COMES OUT OF THE BATTERY!

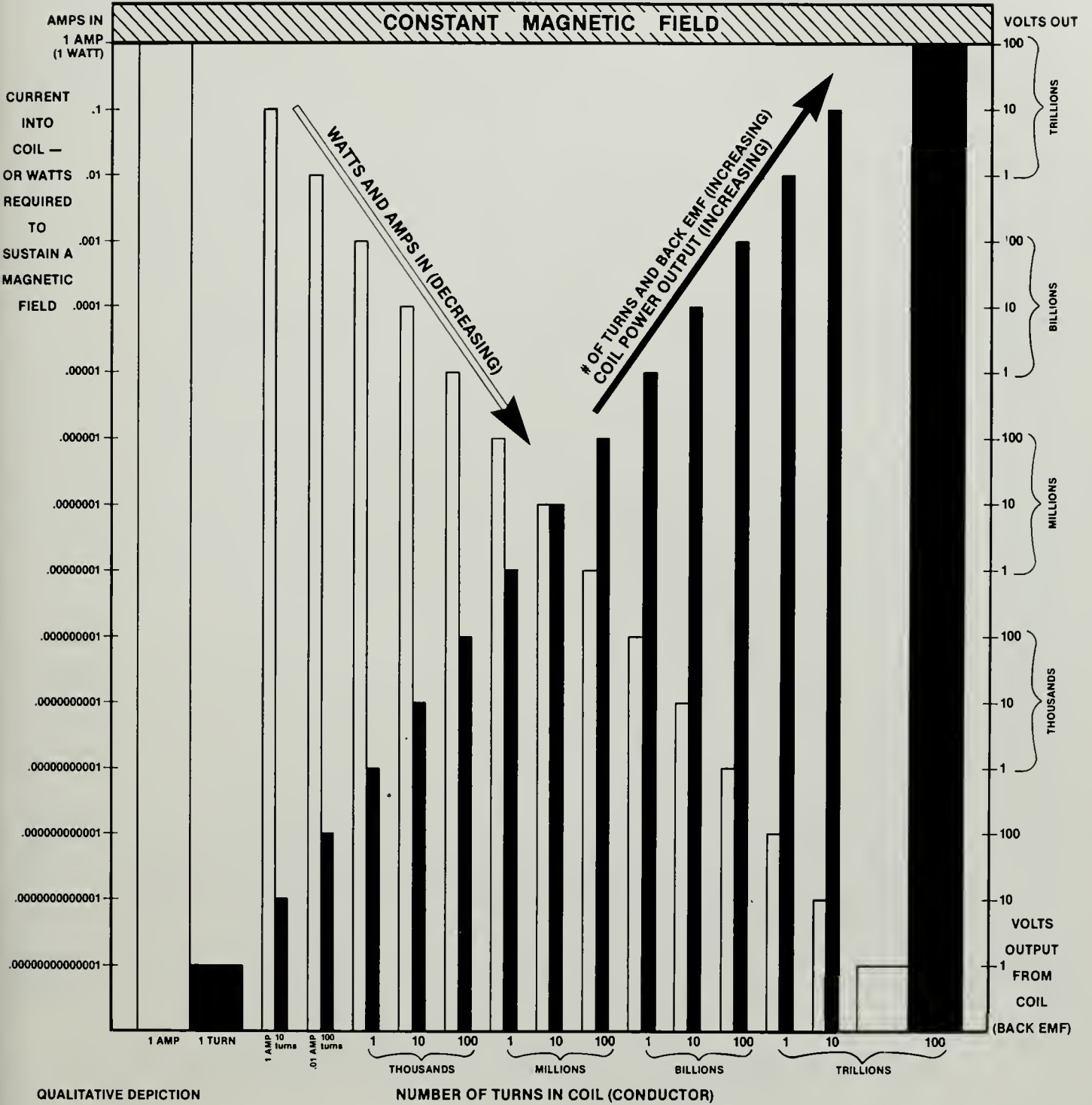

Current in coil

or watts required to sustain
magnetic field

Volts output
from coil

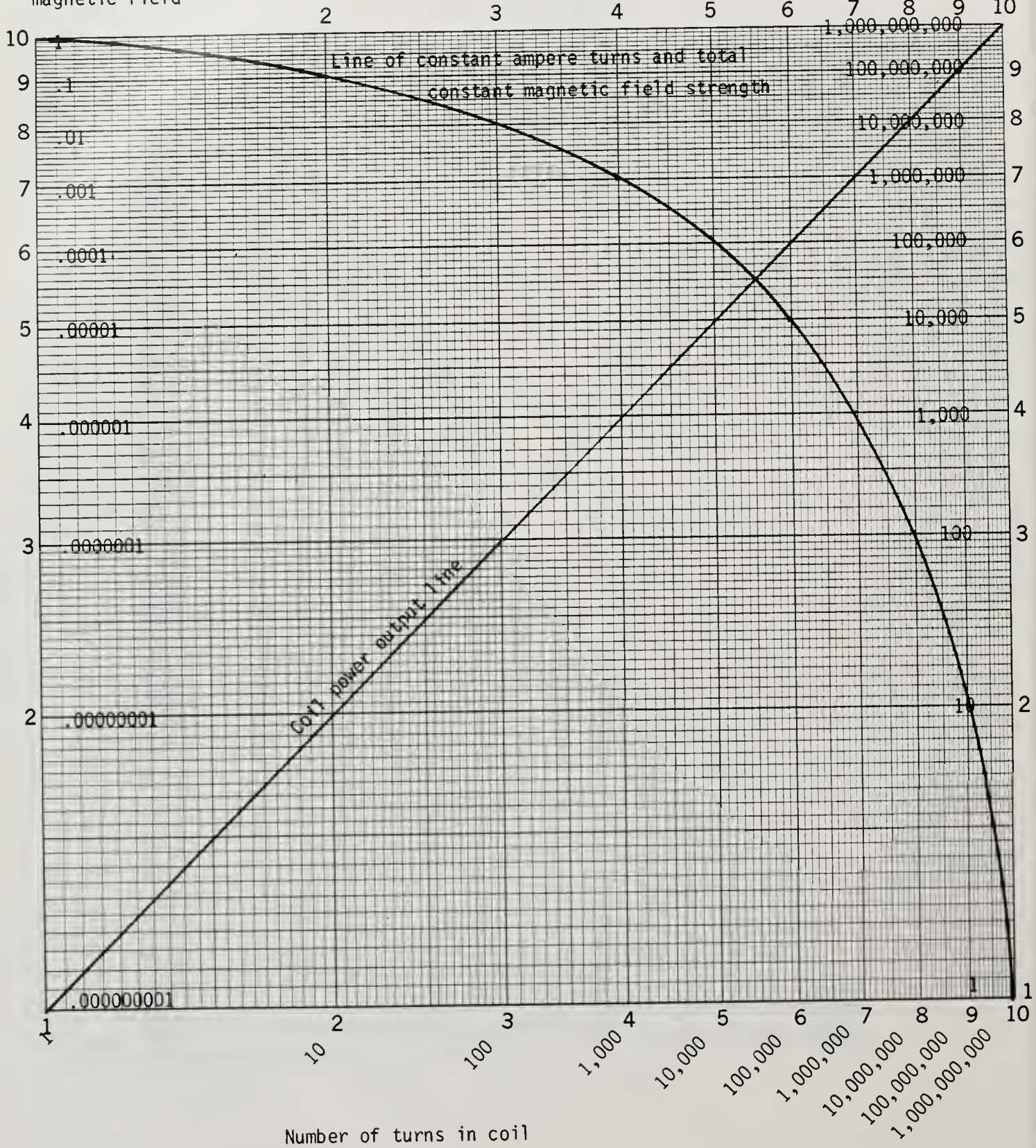

Number of turns in coil

XI. ELECTROMAGNETIC PROPULSION TECHNOLOGY FOR EARTH AND SPACE TRAVEL

[The following diagrams represent a comparison of conventional science technology with those concepts innovated by Joseph Newman. Section XII features a Declaration by Dr. Hastings describing Joseph Newman's electromagnetic propulsion (levitation) technology.]

CONVENTIONAL SCIENCE TEACHES:

Electric Charges

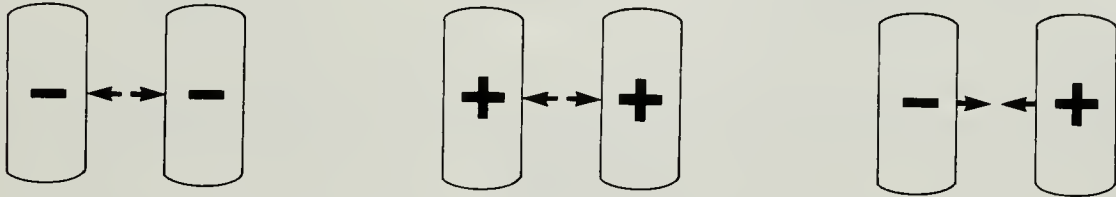

Like Charges Repel — Unlike Charges Attract

Magnets

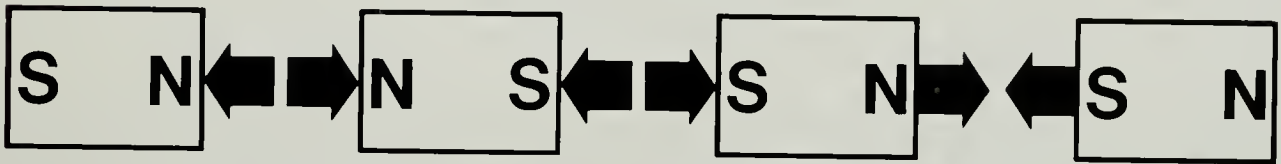

Like Poles Repel — Unlike Poles Attract

Conducting Wire • Electricity • Magnetism

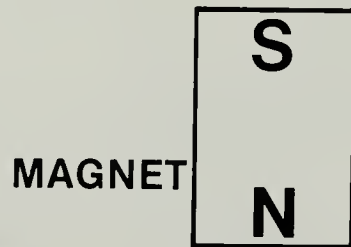
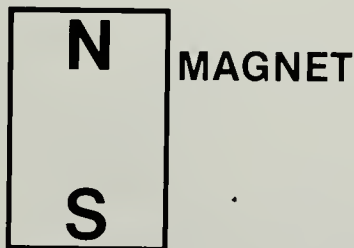

Current going one way in a conductor attracts one pole of a magnet — if current direction reverses, magnet is reversed.

Gravity is different



— it always attracts.

JOSEPH NEWMAN TEACHES THAT THE BASIC BUILDING BLOCK OF ALL MATTER IS THE GYROSCOPIC PARTICLE — A PARTICLE THAT CAN BE MECHANICALLY UNDERSTOOD AND ANTICIPATED AS TO THE NATURE OF ITS ACTION.

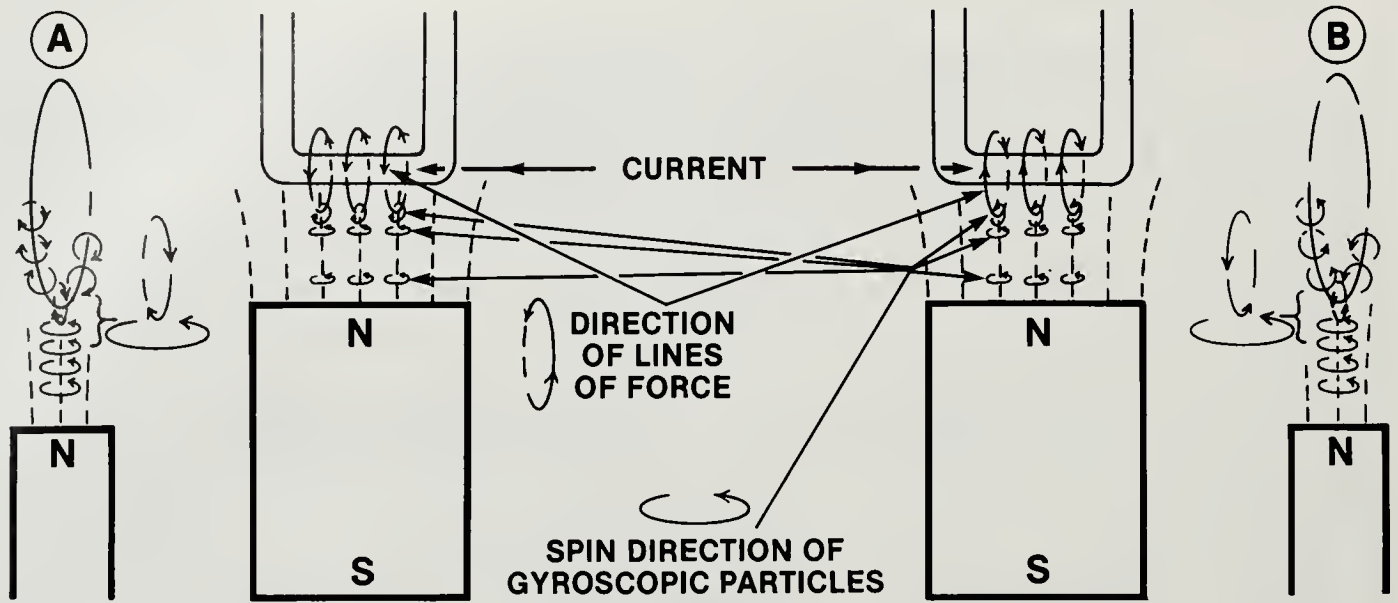

The spins of the GYROSCOPIC PARTICLES which comprise and emanate from the atoms of the conductor are at right angles to the spins of the GYROSCOPIC PARTICLES which emanate from the atoms of the magnet. As a result of this mechanical interaction, the conductor wire is *repelled* from the magnet regardless of the *direction* of the current which passes through and aligns the atoms of the conductor. The conductor should be short enough to intersect with the straighter center line of force and not extend out over the curved lines of force because of the changing mechanical relationships.

The spin of the GYROSCOPIC PARTICLES which comprise and emanate from the atoms of the conductor are at right angles to the spin of the GYROSCOPIC PARTICLES emanating from the atoms of the magnet. As a result of this mechanical interaction, the conductor wire is *repelled* from the magnet regardless of the fact that the magnet's polarity is *reversed* while the direction of the current in the conductor remains the *same* in each instance.

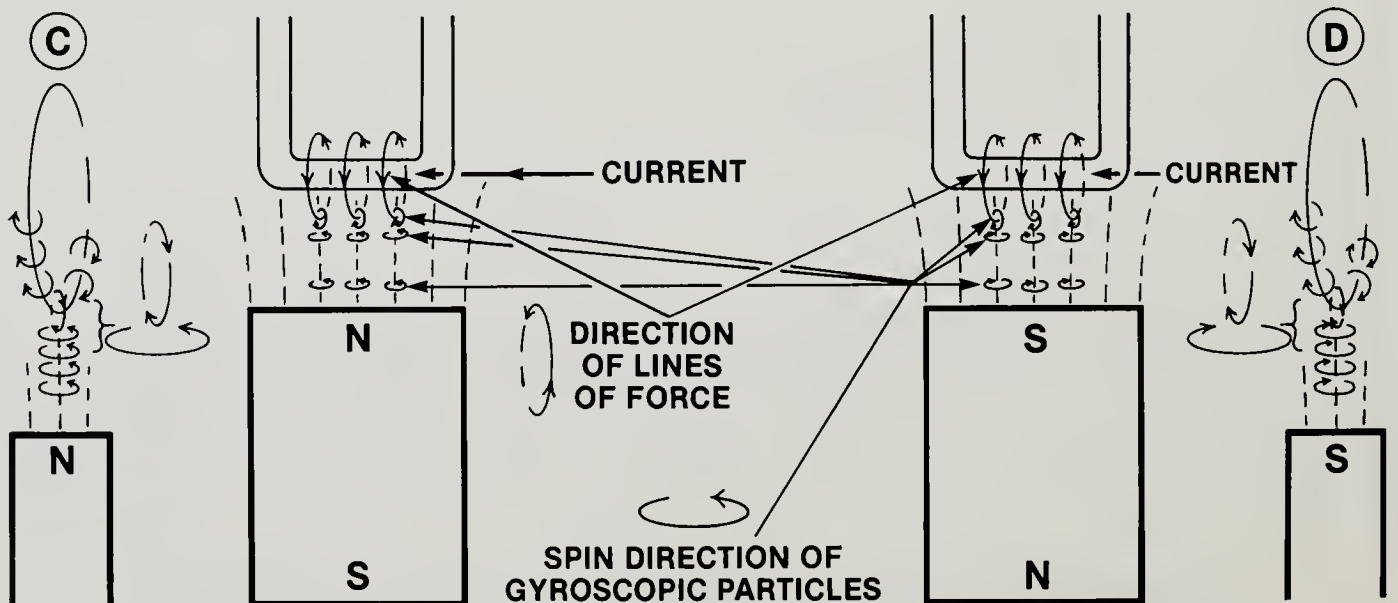

This mechanical explanation for the gyrosopic composition of all matter explains these observed and demonstrated results that defy presently-accepted, but false "scientific" teachings which claim to be absolute.

Such an understanding and subsequent physical effect serves to demonstrate the *opposite* force to gravity which can occur between matter and will enable safe, efficient space travel to become a reality.

8/22/86
1204 Circle High Dr.
Burnsville, Mn. 55337

To Whom It May Concern:

On August 18 and 19, 1986 I visited Joseph Newman's laboratory in Lucedale Mississippi, witnessed the operation of Newman's latest motor, and witnessed his demonstration of levitation from the Earth's magnetic field.

The motor is intended as a prototype of an electric automobile motor. It is approximately eight inches in diameter, and eighteen inches long, with a 3/8 inch diameter shaft emerging from one end. Other components were a 1,400 Volt d.c. battery pack consisting of 250 volt batteries and 9 volt batteries connected in series, and a mechanical commutator. The d.c. current was a fraction of one milliamp nominally. I attempted to stop the motor by holding the rotating shaft with my right hand and applying pressure. While I could not stop the shaft or reduce its speed to below perhaps 100 r.p.m., the motor never drew more than 1.5 milliamps. My examination was brief and qualitative, however I have had many similar experiences with conventional d.c. motors, and I would estimate the power generated at the shaft of this motor to be in excess of 100 Watts. Newman's motor never drew more than 2.5 Watts. The primary purpose of this prototype is to verify that the earlier model (demonstrated and documented earlier as a fan motor) can be scaled up to power a car. The verification appears to be successful, and I recommend immediate efforts to produce the automobile engine prototype.

While at Newman's demonstration in Jackson, Mississippi on August 20, I also witnessed the operation of a Newman motor which was built independently by a Memphis engineer. This motor was running a ceiling fan using 1.5 Watts of d.c. power taken from 13 nine volt transistor batteries. An identical blade was turning at the same speed, driven by a commercial ceiling fan and drawing 40 Watts of a.c. line power. The Newman motor was run continuously for about four hours without noticeable degradation of the batteries. This demonstration independently verifies the conclusion that huge energy savings can be realized by converting from conventional motor technology to Newman motors in appliances, compressors, automobiles, pumps, and all other energy intensive motor applications.

The levitation experiment demonstrated a vertical force exceeding the force of gravity on strands of #40 copper wire when a few hundred milliamps were applied. Application of standard equations for the interaction of the wires with the earth's magnetic field gave approximate agreement that the wires were in fact levitated on the earth's field. Return wires were at the same time forced downward. Newman disclosed to me a design in which the force on the "go" wires should exceed the downward force on the "return" wires. I estimated that a vehicle of Newman's design (with perhaps some modifications to further reduce the force on the return wires) could be made with a self contained power source and passenger compartment which is 1,000 feet or more in diameter. Such a vehicle should be investigated immediately as a replacement for rockets, and as a future means of interplanetary space travel.

The above statements are true and accurate to the best of my knowledge.

Roger Hastings, Ph.D.

XIII. Events occurring between FALL 1985 and FALL 1986 concerning the effort to secure a pioneer patent for Joseph Newman's energy machine.

Chapter 25 of **THE ENERGY MACHINE OF JOSEPH NEWMAN** described the September 1984 REPORT OF THE SPECIAL MASTER to the Federal District Court in Washington, D.C. which has been the site of Joseph Newman's suit against the Patent and Trademark Office (PTO). In the Report, Special Master William E. Schuyler, Jr. wrote that the "*Evidence before the Patent and Trademark Office and this Court is **overwhelming** that Newman has built and tested a prototype of his invention in which the output energy exceeds the external input energy; there is **no** contradictory factual evidence.*" and "*Defendant [PTO] intentionally did not consider the formalities of Plaintiff's (Joseph Newman's) application or the patentability of Plaintiff's claims under 35 USC sec. 102/103.*"

For many months and expensive trips to Washington, D.C., Mr. Newman and his attorney, John Flannery, attempted to obtain a decision from Judge Thomas P. Jackson either accepting or rejecting the Special Master's findings. Rule 53 of the Federal Rules of Civil Procedure provides that the Judge "*shall accept the findings of the Special Master.*" Finally, in June of 1985, Judge Jackson rejected **without reason** [and as of this writing we still await his reason] the findings of his own Court expert and Special Master. However, Jackson did see fit to charge Joseph Newman \$11,602.20 for this ignored and rejected Report.

Judge Jackson originally stated that he chose the Special Master to assist in "the speedy disposition of the trial" and to "reduce the Applicant's (Joseph Newman's) expenses." However, the Judge's *actions* belie his words: After many hearings, two trial dates have been canceled with a new date set for December 8, 1986; moreover, the litigation expenses to Joseph Newman have been **compounded** by Jackson's actions!

Also, to return to an earlier event: In December, 1984, PTO Commissioner Gerald Mossinghoff arranged to have \$100,000.00 of Energy Act funds — intended by Congress to finance the development of new energy systems — misappropriated to discredit Mr. Newman's invention. Mossinghoff made an unprecedented agreement with the National Bureau of Standards (NBS). Mossinghoff ran little risk from the NBS since he had the NBS "expert" Jacob Rabinow file a sworn declaration that Mr. Newman's device did not operate. Jacob Rabinow gave this opinion without even testing the energy machine.

After rejecting the findings of the Special Master in June, 1985, Judge Jackson remanded the case **back** to the Patent Office — Mr. Newman's judicial adversary — for further action. The PTO then recommended that the NBS formally test Mr. Newman's invention.

In the original test conditions, Judge Jackson **1)** refused to order the NBS to prepare a testing program in advance of delivery of the energy machine to the NBS, **2)** refused to permit Mr. Newman the right to have an ex-

pert present for testing, **3)** stated that the test results would be issued in secret to Judge Jackson who said in the court record that "it (the test results) will be held under seal until we determine that it ought to be exhibited to the public," and **4)** gave the NBS an open-ended period of testing.

On behalf of Mr. Newman, John Flannery filed a WRIT OF MANDAEMUS with the U.S. Court of Appeals, seeking to reverse Jackson's unfair testing conditions in favor of those test conditions proposed by Mr. Newman.

On January 13, 1986, the U.S. Court of Appeals for the Federal Circuit issued a court order [*In re Newman*, 782, F2d 971, 974-75 (Fed Cir. 1986)] **upholding** Joseph Newman's WRIT OF MANDAEMUS against Judge Jackson. The higher court sternly rebuked Jackson for ordering "highly irregular" testing procedures that denied Joseph Newman "fundamental fairness" guaranteed him by the Federal Rules. Jackson had originally ordered Joseph Newman to surrender his energy machine to the NBS so that Office might dismantle or even destroy it. Instead, the U.S. Court of Appeals rejected **all** of Jackson's conditions for testings and supported Mr. Newman's position. [As it turned out, this action did no good, because Jackson/NBS/PTO did exactly what they wanted to do!] The higher Court criticized Jackson for authorizing the destruction of Joseph Newman's invention and giving "no reason for barring petitioner from observing all the tests on his device, or from knowing in advance what tests are to be conducted [by NBS]." The Court concludes; "Such procedures are highly irregular, and taint the evidentiary value of the test results."

Specifically, the U.S. Court of Appeals ordered that: **1)** the NBS tests be prepared in advance of the energy machine's delivery to the NBS, **2)** Joseph Newman could be present for testing as well as have an expert on his behalf, **3)** the energy machine could not be dismantled or destroyed without Joseph Newman's consent, **4)** the NBS would have 30 days **AND NO MORE** to test the energy machine [this was reaffirmed by the higher Court in a letter issued on February 12, 1986 during the original and authorized 30-day test period from January 24 - February 23, 1986], and **5)** the results would be issued openly and publicly to all parties.

During the original 30-day test period (from January 24 - February 23, 1986) the NBS did not conduct a *single* test. The PTO and the NBS asked the Court of Appeals to change its mind and let the NBS dismantle and destroy the energy machine. On February 12, 1986, for the second time, the Court of Appeals said **no**: "[NBS's] Dr. Hebner has not attested to his inability to test the device or that its [the energy machine's] structure is concealed, or that a test program cannot be reasonably conducted to ascertain whether the device performs as disclosed in the patent application" and "on reconsideration, we affirm the prior order."

The NBS *still* refused to test the energy machine and to run a single test unless they were permitted to destroy the energy machine. Even *before* any tests had been performed, NBS representatives told the Court of Appeals that the energy machine was a hoax. This attitude was one of the reasons that the higher Court recognized that the NBS had acted in a biased manner towards Joseph Newman and his work. Meanwhile, the NBS offered a thousand excuses — each of which Joseph Newman answered — in an effort to run the clock while they waited for permission to destroy the energy machine *e.g.*, the NBS insisted on communicating by mail, rather than by phone. In another instance, the NBS required Joseph Newman to travel 1,000 miles from Mississippi to Maryland to move a single wire a distance of one inch. Joseph Newman and attorney John Flannery gave the NBS permission to reconnect the wire that had come loose in shipping from Mississippi to Maryland. The NBS insisted that Joseph Newman do it. Even after Joseph Newman did this — after he traveled 1,000 miles — the NBS refused to test the energy machine or even tell Joseph Newman when or how they would test it.

During this 1,000-mile trip to reconnect the wire by one inch, an event occurred which would have great significance later on. The approximately 135-pound energy machine delivered to the NBS facility in Maryland would — if not restricted by resistance — “pump” back-EMF into the battery pack and thus proceed to over charge and damage the batteries by shorting them out internally. Normally, Joseph Newman placed 4 ft. fluorescent bulbs in the circuit to act as a release valve to reduce this back-EMF into the batteries. Since it was inconvenient to carry 4 ft. fluorescent bulbs on the plane to Maryland the day Joseph Newman reconnected in several minutes the loose wire, Mr. Newman simply grounded the energy machine to shunt away the back-EMF and prevent it from damaging the batteries.

What is most ironic is that NBS officials saw Joseph Newman **ground** the energy machine and therefore **assumed** that he **always** grounded it — even for testing! The NBS officials were not interested in mastering Joseph Newman’s technical process and understanding the principles involved. Instead — like “monkey see — monkey do” — they later grounded the energy machine during their secret testing of the confiscated energy machine. This action would have important ramifications re the validity of the NBS test. [It should also be added that Joseph Newman had *no* intent of “educating the NBS personnel.” They were supposed to be the experts; Joseph Newman’s attitude was, “let’s see what the experts do.”]

The experts did nothing during the authorized 30-day test period that expired on February 23, 1986. On Monday, 10:30AM on February 24, 1986, John Flannery appeared at the NBS building in Gaithersburg, Maryland where the energy machine was being held. Joseph Newman had asked Mr. Flannery to return the energy machine to Mississippi. Armed guards met Mr. Flannery and refused to permit him to obtain Mr. Newman’s prop-

erty. Mr. Flannery was informed that he had until 12 noon of that day to appear at an emergency meeting in Judge Jackson’s courtroom. Should he fail to appear, Jackson would issue a warrant for his arrest.

Mr. Flannery did appear in the courtroom by 12 noon. He was promptly informed by Judge Jackson that the energy machine of Joseph Newman was now the property of Jackson’s court and the invention would not be turned over to Mr. Newman. Mr. Flannery asked Jackson for his reasons for such confiscation. The Judge refused to give any. Mr. Flannery then asked Jackson to remove himself as the Judge in the case because of demonstrated personal bias and prejudice. Jackson denied that he was prejudiced and continued to refuse to tell Mr. Flannery what authority permitted the Judge to violate the Court of Appeals Order. As Joseph Newman said: *“Since when in this country can a court take a person’s property, seize it without even a hearing and in violation of a standing order of an appellate court? Something is very wrong here.”*

On March 3, 1986, as a result of the Court’s questionable procedures, Joseph Newman submitted an Affidavit in support of a motion to disqualify Judge Jackson for his demonstrated personal bias and prejudice. On March 7, 1986, the District Court held a status conference to consider giving the NBS more time to test the energy machine in violation of the 30-day period authorized by the U.S. Court of Appeals.

Immediately before this status conference began, Judge Jackson’s law clerk handed John Flannery an order denying Joseph Newman’s motion to disqualify Jackson as insufficient, but without any discussion as to why the pleadings were factually insufficient. Jackson even held John Flannery in contempt for merely mentioning the pending motion to disqualify him. Jackson then gave the PTO/NBS until June 26, 1986 to test the energy machine — **150 days** after the energy machine was originally delivered.

Joseph Newman could not afford to be present with counsel and expert for the 12-hour work-days the NBS claimed they worked each day. It would have cost Joseph Newman over \$60,000.00 to attend the tests and is one of the reasons why the U.S. Court of Appeals authorized the original 30-day test period. Former PTO Commissioner Mossinghoff misappropriated \$100,000 to run these unprecedented tests. According to the Patent Office, the tests cost approximately \$75,000.00. Although Joseph Newman had the “right” to attend the later, unauthorized tests on his confiscated energy machine, it was a “right” that he could not afford to exercise. Joseph Newman is not a large corporation. He is an inventor who lives by what he invents. Worse, the PTO had said that they expect Joseph Newman to reimburse the PTO for all NBS tests!

It is, in fact, Joseph Newman’s position that **all** PTO/NBS/Jackson actions taken *after* the February 24, 1986 confiscation without-due-process of his property are illegal and unconstitutional. As a result of this position and of the expense in attending 90 additional days

of testing, Joseph Newman would not in any way wish to appear to endorse the NBS proceedings by being present for their testing. Also, it should be noted that before the NBS ran any tests, John Flannery forwarded to the NBS a schematic diagram of the circuit used to test Newman's device. It plainly showed **not** to connect the energy machine to ground.

Prior to the expected release of the NBS test [conducted by three individuals] on June 26, 1986, Joseph Newman issued a national press release sent to over 1500 members of the press which predicted that the NBS test results would be negative and that "a mockery of justice is expected to continue in the chambers of Judge Thomas P. Jackson." On June 26, 1986, the NBS unsurprisingly said that Joseph Newman's invention did not work. Moreover, Judge Jackson set a trial date for **December 8, 1986**. (Up to this point, Jackson had held a series of expensive hearings to determine if a trial was warranted and had canceled two earlier trial dates.) Jackson continued to refuse to relieve himself from this case due to bias, and Jackson refused to allow Joseph Newman a trial by jury. In fact, a Patent Office attorney once told Joseph Newman's attorney, "We would hate to see this case tried by a jury."

It is ironic that as a consequence of the Patent Office's disregard of the Court of Appeals' requirement that the NBS notify Joseph Newman of what tests they intended to run during the 30-day test period authorized by the Court of Appeals, Joseph Newman did not know how the NBS "tested" his machine until **after** the NBS issued its report on June 26, 1986. Consequently, Joseph Newman discovered that the NBS did not actually test his invention at all.

In one of his PRESS RELEASES, Joseph Newman writes: "In his April 9, 1984 Statutory Declaration before a Federal Court, page 10, NBS expert Jacob Rabinow claimed the following — 'It is my opinion since Mr. Newman does not use a tightly-coupled iron structure around his armature, that the efficiency of his motor should be very low when use purely as a motor.' Following the release of the June 26, 1986 NBS Report (which has been challenged by Dr. Hastings and other scientific experts), NBS spokesman Matt Heyman boastfully stated to the newsmedia that: 'the energy machine invention was so inefficient that if one wanted to operate an **electric fan**, then don't use the Newman Invention hooked to a battery, but rather use a simple conducting wire from a battery to a conventional motor.' The above two statements by NBS representatives Rabinow and Heyman are *especially ironic* because on July 30, 1986 — in conjunction with an appearance before the Senate Subcommittee on Energy Hearing — Joseph Newman demonstrated his latest, portable energy machine prototype which operates as a **motor** (without Rabinow's 'tightly-coupled iron structure around the armature') to power a home-appliance, **electric fan** at an efficiency rate that proved the Patent Office and the NBS dead wrong. Again."

Dr. Roger Hastings, Senior Physicist with a major

research corporation, concluded that the PTO's trial expert, the NBS — the 'preeminent national testing laboratory' — failed to measure the energy in Joseph Newman's energy machine although it had the energy machine for 150 days. His evaluation was that the NBS personnel did not know what they were doing. As John Flannery said, "*The Court of Appeals gave the Patent Office 30 days to test the energy machine and required the Patent Office to inform us in advance what tests they were going to run during the 30-day test period authorized by the U.S. Court of Appeals. But their expert, the NBS, kept the device 150 days and never told us what tests they were going to run during this 30-day period.*" In his evaluation, Dr. Hastings wrote that the NBS "results reflect a total lack of communication between the NBS and Newman or any other expert on Newman's technology." As John Flannery put it, "*If they told us what they were going to do, we might have been able to avoid this waste of time and resources by Mr. Newman and the taxpayers as well.*"

Specifically, Dr. Hastings said in his evaluation that the NBS allowed energy to escape from Mr. Newman's energy machine and then, instead of measuring the output energy from the energy machine, they measured the power consumed by resistors "placed in parallel with the Newman motor, and called this power the motor output." Dr. Hastings concluded, "the primary r.f. (radio frequency) power was shunted to ground." As for measuring output, Hastings said that the NBS's test was "equivalent to stating that the output of an electric motor plugged into a wall socket is given by the power used by a lightbulb in the next room which is on a parallel circuit." "*The NBS test results came as no surprise to me,*" said Mr. Newman, "*I never expected that we would get a fair shake from the Patent Office's expert. What I am surprised about is how badly they did the job.*"

If the PTO and the NBS had complied with the Court of Appeals Order, Joseph Newman would have had a second opportunity to reinforce what was already obvious from the schematic diagram forwarded by John Flannery to the NBS — that they should **not** connect Joseph Newman's energy machine to ground. The NBS could have been told that they were in error. But since the NBS and PTO failed to give Joseph Newman any notice — contrary to the U.S. Court of Appeals Order — of the tests they intended to run during the 30-day test period authorized by the Court of Appeals, they wasted Joseph Newman's resources and, by their estimates, \$75,000.00 of federal taxpayer's monies misappropriated by former PTO Commissioner Gerald Mossinghoff.

The REPUBLICAN STUDY COMMITTEE of Congress wrote in its May 9, 1986 REPORT: "Joseph Newman has received arbitrary and unfair treatment at the hands of the PTO and Judge Jackson. Congress should act because the Executive and Judicial branches have failed this American citizen. In light of Congress' oversight responsibilities and the fact that it is empowered by the Constitution to issue patents, the fact that the preponderance of

Notable public events of the past year:

- 1) **OCTOBER 9, 1985:** Joseph Newman conducted a public demo at the Hilton Hotel in New Orleans — over 2500 people attended.
- 2) **OCTOBER 16, 1985:** Joseph Newman addressed the New Orleans section of the IEEE at the International Hotel.
- 3) **DECEMBER, 1985:** REGARDIES MAGAZINE published an excellent and comprehensive article on Joseph Newman.
- 4) **JANUARY 14, 1986:** Joseph Newman addressed the Mississippi Engineering Society (Gulf Coast Chapter) in Gulfport, Mississippi
- 5) **FEBRUARY 25, 1986:** Joseph Newman formally presented his theories and technical processes before 1500 people at Louisiana State University [sponsored by Am. Soc. of Mech. Engr., Student Chap., LSU College of Design, & the HELENE Foundation].
- 6) **FEBRUARY 27, 1986:** Joseph Newman appeared with Johnny Carson on the TONIGHT SHOW.
- 7) **APRIL 11-17, 1986:** Joseph Newman held a nat'l public demo of his EM in the LOUISIANA SUPERDOME. Over 8,500 people attended from across the U.S. It was a very successful presentation that was well received. On Wed., April 16, 1986, Joseph Newman challenged any scientist and/or PhD with teaching or professional credentials to publicly debate w/him at the SUPERDOME the fundamentals of electromagnetism. No one accepted his challenge.
- 8) **MAY 9, 1986:** The Republican Study Committee of Congress issued its **Report** in support of Joseph Newman entitled: "THE PATENT OFFICE AND JOSEPH NEWMAN: AN ABUSE OF POWER."
- 9) **MAY 29, 1986:** Joseph Newman addressed the Mississippi House of Representatives & demonstrated his portable, appliance-fan-powered EM. JN received a standing ovation & both the Miss. House & Senate passed Resolutions supporting his Congressional effort to obtain a patent.
- 10) **JULY 30, 1986:** Joseph Newman, John Flannery, Dr. Roger Hastings, Milton Everett, Congressman Thomas Kindness, Congressman Dan Burton, and PTO/NBS representatives testified before Senator Thad Cochran's Senate Subcommittee on Energy, Nuclear Proliferation, & Government Processes.
- 11) **AUGUST 20, 1986:** Joseph Newman demonstrates his latest fan-powered prototype & his new electromagnetic propulsion (popularly called "anti-gravity") system at a news conference at the Sheraton Regency Hotel in Jackson, Mississippi.
- 12) **SEPTEMBER, 1986:** LIFE MAGAZINE published a 2-page feature story on Joseph Newman.
* VCR tapes of these presentations are now available.

evidence is in Newman's favor, and the fact that this invention is potentially beneficial to hundreds of millions of people, it is totally in order for Congress to grant Newman a patent and to allow the American marketplace to decide the value of this invention."

During June-August, 1986, nationally-syndicated columnist James J. Kilpatrick wrote three different articles on Joseph Newman's struggle with the Patent Office. In addition, numerous articles appeared in publications, newspapers, with interviews on radio, and on the TV (National ABC WEEKEND NEWS, CNN National News, Johnny Carson's TONIGHT SHOW, etc.). It is important that this issue remains a public issue until the patent is issued — this is Joseph Newman's only protection from the unjust actions of a Federal Bureaucracy and a Federal Court. The ENERGY MACHINE NEWSLETTER contains news updates concerning Joseph Newman's work. Those interested in obtaining information about the NEWSLETTER should write Joseph Newman at Route 1, Box 52, Lucedale, Mississippi 39452.

Meanwhile, the Patent Office continues to issue statements that are totally false. PTO Commissioner Donald J. Quigg (a former top executive at PHILLIPS PETROLEUM for 33 years) wrote in a form letter dated June 17, 1986 sent to people who wrote him about PTO mistreatment of Joseph Newman: "Mr. Newman has filed an application for a patent on his invention of a method and apparatus for obtaining more energy from a machine than is put into it. This application is related to several earlier filed applications, *all since abandoned by Mr. Newman.*"

This is typical of the Patent Office's misleading rhetoric and represents a concentrated effort on the part of the Patent Office to discredit Mr. Newman and misinform the public. In a June 25, 1986 letter by Joseph Newman's patent attorney C. Emmett Pugh, Pugh writes: "In summary, you have **never** in fact or in law abandoned in any way any of your patent rights or your efforts to obtain

your due patent rights, and each later application carried forth the disclosures of your earlier applications and added to them your then current, up-dated information. The later filings benefit the public, and your rights and claims are in no way diminished or considered abandoned by the up-dating process."

Added to this Edition of the book are a number of Declarations by Dr. Roger Hastings which endorse the operation of the energy machine, the portable fan-motor prototype, and the new electromagnetic propulsion system.

The New Orleans City Council unanimously adopted a Resolution on November 7, 1985 which read in part: "BE IT RESOLVED BY THE COUNCIL OF THE CITY OF NEW ORLEANS, that it hereby endorses the adoption of H.R. 3590 induced by U.S. Representative Dan Burton which would put an end to the costly multi-year litigation over the Joseph Newman energy machine by resolving any doubts in favor of the applicant and providing for the issuance of a patent because it is the Council's firm belief that the best judge of Joseph Westley Newman's invention is not a Court listening to experts testifying on either side, but the American free market with its harsh but fair test of practicality."

The Senate and House of Representatives in Mississippi issued a CONCURRENT RESOLUTION #294 (dated April 10-11, 1986) which stated in part: "WHEREAS, Federal District Court Judge Thomas P. Jackson ordered highly irregular testing procedures which denied Mr. Newman fundamental fairness in receiving patent approval; and WHEREAS Judge Jackson has taken Mr. Newman's property without even a hearing and in violation of a standing order of an appellate court and has subsequently ordered secret tests by NBS of the illegally confiscated energy machine, again totally contrary to the order of the U.S. Court of Appeals; NOW, THEREFORE BE IT RESOLVED BY THE HOUSE OF REPRESENTATIVES OF THE STATE OF MISSISSIPPI, THE SENATE CONCURRING THEREIN,

John Flannery

Janney House
Waterford, Virginia 22190
703-882-3175

3847 North Tazewell Street
Arlington, Virginia 22207
703-534-7464

October 24, 1985

Dear friend,

Joe has asked me to give you a summary of (1) why you should encourage members of Congress on the relevant committee(s) to support a private bill, H.R. 3590, recently introduced by Rep. Dan Burton, and (2) briefly state the facts in support. And so I have.

There are four reasons why a private patent bill for Mr. Newman is worthy of your support:

Firstly, no citizen should be so shabbily treated as has Newman by both administrative and judicial tribunals -- the Patent Office and by the Courts -- in direct contravention of the Constitution and the statutes of Congress,

Secondly, if Newman had been fairly treated, the Patent Office and the Court would have seen that Newman's device works -- as a former U.S. Patent Commissioner has so attested -- and that he is entitled to a patent,

Thirdly, if Newman secures the protection for himself to manufacture this device, it shall mean a new source of inexpensive and efficient energy, and

Fourthly, this bill doesn't cost us as taxpayers a dime and may instead save us money -- in energy bills.

A Statement of the Facts

As for the salient features, a statement of the facts, that I find disturbing:

Newman's patent application when it arrived at the Patent Office in 1980 was assigned to a Patent Examiner found incompetent by the federal district Court in Texas. The Patent Office refused to look at Newman's evidence including a prototype he constructed to prove it worked. The Patent Examiner said he doubted he would ever grant Newman a patent no matter what proof he presented and the Patent Office refused to replace the prejudiced patent examiner. Thus did the Patent Office deny Newman a patent.

Newman appealed his Patent Office rejection to the US District Court in January 1983. See 35 U.S.C. Section 145. The Patent Office again refused Newman's offers made during civil discovery to have them test his device; the Patent Office said they "must" rely on the applicant's tests. The Court said it was technically incompetent to decide the case and appointed former Patent Commissioner Schuyler to consider the case. The former Patent Commissioner concluded:

(more)

PAGE TWO

- (1) there was overwhelming evidence, without contradiction, that Newman's device operated as claimed,
- (2) that the Patent Office had disregarded its own rules in rejecting Newman's claims,
- (3) that the Patent Office's determination that Newman machine was "impossible" was "clearly erroneous", and
- (4) that a patent should issue.

The Court refused to accept the Master's findings and reopened discovery.

Newman offered again to permit the Patent Office to test his device. But the Patent Office doesn't want to test it; not fairly anyhow; they say they will only conclude Newman's device operates if he'll permit them to destroy it.

Thus the need for a private bill.

Conclusion

I believe no doubt as you do that a private bill should only issue rarely and under special circumstances. Mr. Newman's case is certainly rare and the circumstances cry out for relief. A private bill, in the waning days of Congress, is the way to give Newman the relief he needs and deserves.

Thanks for your time and, I hope, for your support of Joe. Joe is absolutely right your letter(s) to members of the House and Senate can make the difference.

Sincerely yours,

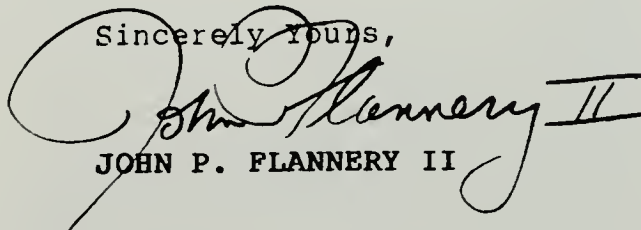

JOHN P. FLANNERY II

JPF/pm

That we do support Mr. Newman in this endeavor and do hereby commend the Mississippi Congressional Delegation for their past and continued support."

On May 29, 1986 the Senate of Mississippi issued RESOLUTION #3 which stated in part: "BE IT RESOLVED BY THE MISSISSIPPI STATE SENATE, That we do hereby memorialize the United States Secretary of Commerce, acting through the Commissioner of Patents and Trademarks, and the United States Patent and Trademark Office to issue a patent to Joseph W. Newman for the energy machine and memorialize the United States Congress to adopt legislation directing that such patent be issued."

As of this writing, ten Congressmen — who are outraged over the treatment of Joseph Newman by the Patent Office and Judge Jackson — have introduced 10 House Bills to grant Joseph Newman a pioneering patent for his invention.

H. R. 3590

For the relief of Joseph W. Newman

IN THE HOUSE OF REPRESENTATIVES

February 11, 1986

Mr. TRENBERG introduced the following bill, which was referred to the Committee on the Judiciary

A BILL

For the relief of Joseph W. Newman

1. *Be it enacted by the Senate and House of Representatives in Conference assembled,*
2. *That the Secretary of Commerce, acting through the Commissioner of Patents and Trademarks, shall immediately issue a patent to Joseph W. Newman for the invention described in the patent application numbered 179,474 and filed in August 1980. Such patent shall be accorded rights equal to the rights accorded to patents issued under title 35, United States Code.*

H. R. 3977

For the relief of Joseph W. Newman

IN THE HOUSE OF REPRESENTATIVES

February 11, 1986

Mr. LARRY introduced the following bill, which was referred to the Committee on the Judiciary

A BILL

For the relief of Joseph W. Newman

1. *Be it enacted by the Senate and House of Representatives in Conference assembled,*
2. *That the Secretary of Commerce, acting through the Commissioner of Patents and Trademarks, is authorized and directed to immediately issue a patent to Joseph W. Newman for the invention described in the patent application numbered 179,474 and filed in August 1980. Such patent shall be accorded rights equal to the rights accorded to patents issued under title 35, United States Code.*

H. R. 4081

For the relief of Joseph W. Newman

IN THE HOUSE OF REPRESENTATIVES

January 29, 1986

Mr. LUTHELMAN introduced the following bill, which was referred to the Committee on the Judiciary

A BILL

For the relief of Joseph W. Newman

1. *Be it enacted by the Senate and House of Representatives in Conference assembled,*
2. *That the Secretary of Commerce, acting through the Commissioner of Patents and Trademarks, shall immediately issue a patent to Joseph W. Newman for the invention described in the patent application numbered 179,474 and filed in August 1980. Such patent shall be accorded rights equal to the rights accorded to patents issued under title 35, United States Code.*

H. R. 4200

For the relief of Joseph W. Newman

IN THE HOUSE OF REPRESENTATIVES

February 10, 1986

Mr. LUTHELMAN introduced the following bill, which was referred to the Committee on the Judiciary

A BILL

For the relief of Joseph W. Newman

1. *Be it enacted by the Senate and House of Representatives in Conference assembled,*
2. *That the Secretary of Commerce, acting through the Commissioner of Patents and Trademarks, is authorized and directed to immediately issue a patent to Joseph W. Newman for the invention described in the patent application numbered 179,474 and filed in August 1980. Such patent shall be accorded rights equal to the rights accorded to patents issued under title 35, United States Code.*

H. R. 4220

For the relief of Joseph W. Newman

IN THE HOUSE OF REPRESENTATIVES

February 24, 1986

Mr. TRENBERG introduced the following bill, which was referred to the Committee on the Judiciary

A BILL

For the relief of Joseph W. Newman

1. *Be it enacted by the Senate and House of Representatives in Conference assembled,*
2. *That the Secretary of Commerce, acting through the Commissioner of Patents and Trademarks, shall immediately issue a patent to Joseph W. Newman for the invention described in the patent application numbered 179,474 and filed in August 1980. Such patent shall be accorded rights equal to the rights accorded to patents issued under title 35, United States Code.*

H. R. 4490

For the relief of Joseph W. Newman

IN THE HOUSE OF REPRESENTATIVES

March 31, 1986

Mr. TRENBERG introduced the following bill, which was referred to the Committee on the Judiciary

A BILL

For the relief of Joseph W. Newman

1. *Be it enacted by the Senate and House of Representatives in Conference assembled,*
2. *That the Secretary of Commerce, acting through the Commissioner of Patents and Trademarks, shall immediately issue a patent to Joseph W. Newman for the invention described in the patent application numbered 179,474 and filed in August 1980. Such patent shall be accorded rights equal to the rights accorded to patents issued under title 35, United States Code.*

H. R. 4707

For the relief of Joseph W. Newman

IN THE HOUSE OF REPRESENTATIVES

April 29, 1986

Mr. TAYLOR introduced the following bill, which was referred to the Committee on the Judiciary

A BILL

For the relief of Joseph W. Newman

1. *Be it enacted by the Senate and House of Representatives in Conference assembled,*
2. *That the Secretary of Commerce, acting through the Commissioner of Patents and Trademarks, is authorized and directed to immediately issue a patent to Joseph W. Newman for the invention described in the patent application numbered 179,474 and filed in August 1980. Such patent shall be accorded rights equal to the rights accorded to patents issued under title 35, United States Code.*

H. R. 5032

For the relief of Joseph W. Newman

IN THE HOUSE OF REPRESENTATIVES

June 12, 1986

Mr. TAYLOR introduced the following bill, which was referred to the Committee on the Judiciary

A BILL

For the relief of Joseph W. Newman

1. *Be it enacted by the Senate and House of Representatives in Conference assembled,*
2. *That the Secretary of Commerce, acting through the Commissioner of Patents and Trademarks, is authorized and directed to immediately issue a patent to Joseph W. Newman for the invention described in the patent application numbered 179,474 and filed in August 1980. Such patent shall be accorded rights equal to the rights accorded to patents issued under title 35, United States Code.*

H. R. 5149

For the relief of Joseph W. Newman

IN THE HOUSE OF REPRESENTATIVES

June 30, 1986

Mr. THORNTON introduced the following bill, which was referred to the Committee on the Judiciary

A BILL

For the relief of Joseph W. Newman

1. *Be it enacted by the Senate and House of Representatives in Conference assembled,*
2. *That the Secretary of Commerce, acting through the Commissioner of Patents and Trademarks, shall immediately issue a patent to Joseph W. Newman for the invention described in the patent application numbered 179,474 and filed in August 1980. Such patent shall be accorded rights equal to the rights accorded to patents issued under title 35, United States Code.*

H. R. 5315

For the relief of Joseph W. Newman

IN THE HOUSE OF REPRESENTATIVES

July 31, 1986

Mr. TAYLOR introduced the following bill, which was referred to the Committee on the Judiciary

A BILL

For the relief of Joseph W. Newman

1. *Be it enacted by the Senate and House of Representatives in Conference assembled,*
2. *That the Secretary of Commerce, acting through the Commissioner of Patents and Trademarks, is authorized and directed to immediately issue a patent to Joseph W. Newman for the invention described in the patent application numbered 179,474 and filed in August 1980. Such patent shall be accorded rights equal to the rights accorded to patents issued under title 35, United States Code.*

These ten Congressmen include Dan Burton of Indiana, Trent Lott of Mississippi, Thomas Kindness of Ohio, Robert Livingston of Louisiana, Robert Torricelli of New Jersey, William Dannemeyer of California, Billy Tauzin of Louisiana, Hal Daub of Nebraska, Wayne Dowdy of Mississippi, and Henry Hyde of Illinois. From the lobbying perspective, the **more** House Bills that are introduced, the greater the pressure on Congressman Robert Kastenmeier (Chairman of the House Subcommittee on COURTS, CIVIL LIBERTIES, AND THE ADMINISTRATION OF JUSTICE) to schedule hearings on these Bills. If the reader knows of people living in Robert Kastenmeier's Southern Wisconsin (Madison area) District, urge them to pressure Kastenmeier to act. As of this writing, we still need our *first* Senate Bill — consequently we urge *everyone* throughout the country to write Senator Thad Cochran of Mississippi and urge him to act promptly to introduce a Senate Bill identical to the ten House Bills.

The July 30, 1986 hearing before Thad Cochran's Senate Subcommittee on Energy, Nuclear Proliferation and Government Processes was quite interesting. Subcommittee member John Glenn of Ohio acted very irresponsibly during the Hearing which was attended by

over 200 people in the Dirksen Senate Office Building. Following testimony by Joseph Newman, John Flannery, Dr. Roger Hastings, Milton Everett, and others, Joseph Newman demonstrated his latest fan-motor prototype.

The considerable mechanical torque produced by this fan-motor version of the energy machine will have a significant impact upon the development of motors for many commercial uses. At the Senate Hearing, Joseph Newman demonstrated a fan powered by his energy machine and a second, identically-modeled fan plugged into the wall. The watts needed to power the Newman-motor-connected fan at high speed is 6.9 watts (.003 amps X 2300 volts). In addition to powering the fan, six times the current goes back into the batteries than comes out of the batteries. A fluorescent bulb is also simultaneously lighted. At 7.4 watts (.2 amps X 37 volts) — an input approximately equal to that of the Newman motor — the conventional fan motor (plugged into the wall) barely turns. To equal the speed of the Newman-motor-powered-fan, the input into the conventional fan must be raised to 28.5 watts (.38 amps X 75 volts).

In August, 1986, Mr. Newman issued a PRESS RELEASE describing in detail John Glenn's irresponsible actions

which included: entering the chamber of the Senate Hearing after Congressman Thomas Kindness completed his favorable testimony concerning the energy machine [John Glenn is opposing Kindness in the upcoming Ohio Senate election] which only proved that Glenn valued "politics as usual" over hearing the evidence presented before the Subcommittee of which he was a member; Glenn falsely implied that Mr. Newman had a possible conflict-of-interest relationship with the Special Master since Joseph Newman had once met the Special Master several years before the Special Master's Report was issued [this fact had been related *in detail* to Judge Jackson by Joseph Newman before William E. Schuyler, Jr. was appointed as Special Master: Joseph Newman had met Schuyler at the offices of a former patent attorney — a firm to which both Schuyler and the patent attorney belonged — and had met Schuyler for about 10 minutes; Schuyler later told Judge Jackson that he didn't even remember meeting Joseph Newman and Judge Jackson was fully satisfied as to Schuyler's impartiality. Moreover, why didn't Glenn just as rigorously question the PTO representative at the Senate Hearing since the *same* Patent Office official who nominated Schuyler to be Special Master had been a **subordinate** of Schuyler while Schuyler was the PTO Commissioner several years earlier!]; and although Glenn asked to see more demonstrations and tests of the energy machine, he failed to walk down two flights of stairs to witness Joseph Newman's latest demonstrations of his fan-motor prototype.

As CONGRESSMAN TRENT LOTT says, "I do not feel that the Patent Office has done enough to process Mr. Newman's Patent Application. Therefore, I feel that the legislative process is now the best alternative ... In light of Congress' oversight responsibilities and the fact that it is empowered by the Constitution to issue patents, and the fact that this invention is potentially beneficial to hundreds of millions of people, I feel it is totally in order for Congress to grant Mr. Newman a patent."

According to SENATOR JOHN STENNIS, "Mr. Newman has made repeated efforts to get his machine patented and has encountered substantial obstacles at every turn ... If every inventor ran into as many problems in trying to get a patent as Joe Newman has, I doubt that we would have made much scientific progress in the last two centuries, and we certainly would not enjoy many of the products that we take for granted today."

CONGRESSMAN ROBERT LIVINGSTON asks these questions: "Why has the Patent Office, which has been entrusted by Congress with the important task of promoting scientific progress, gone to such lengths to deny this man the legal right to his invention? Why has the Federal Judge's treatment of Newman been so arbitrary and high-handed? Why did it take four months and \$82,000 to test an invention which supposedly doesn't work, and where did the money come from? Clearly, Mr. Newman is being denied his Constitutional right to due process of law. I strongly feel that Congress should act because the Executive and Judicial branches have failed this American Citizen ... It is totally in order for

Congress to grant Newman a patent and to allow the invention to be tested where it should have been tested a long time ago — in the American marketplace."

In his recent testimony before the Senate Hearing concerning Joseph Newman's patent plight, CONGRESSMAN THOMAS KINDNESS states the issues very succinctly when he says, "This is a case where extraordinary action is appropriate. One need only look at the convoluted, tortuous path that this case has taken to know that Mr. Newman has been denied the fundamental fairness and objectivity that is the right of every potential patent holder." He adds, "When reasonable men differ, as they have in this case, the final result should not be a decision by bureaucratic fiat but rather an accommodation should be reached that allows the device to rise or fall on its own merits!" CONGRESSMAN KINDNESS concludes, "The technically competent former head of the PTO and Special Master in this case, Mr. Schuyler, said that a patent should be issued and in light of Judge Jackson's refusal to follow federal law with respect to the findings of such a Special Master, I believe Congress should step in and grant the patent; then the people can decide if it actually works."

CONGRESSMAN WAYNE DOWDY says that "no one should have to endure the treatment Mr. Newman has undergone at the hands of the United States Patent and Trademark Office (PTO)." And he adds that "instead of promoting Mr. Newman's invention, the PTO has spent thousands of taxpayer dollars to thwart him ... Mr. Newman has submitted an impressive list of experts who substantiate his claims. On the other hand, tests conducted by the PTO have cast more doubt on its methods than on the effectiveness of Mr. Newman's machine ... Furthermore, ***if the PTO denies this country the benefits of what could be a revolutionary energy device, then its obstinacy would, in my mind, be criminal.***" CONGRESSMAN DOWDY concludes, "In my opinion, the PTO has failed and it is up to Congress to take corrective action ... I hope the Senate will support Mr. Newman and move to grant him a pioneering patent."

Hopefully, Senator Thad Cochran will **act soon** and introduce a Senate Bill to grant Joseph Newman a pioneer patent by Congressional action. As of this writing, your letters to Senator Cochran are *very* important!

From the very beginning, Joseph Newman has asked only for the equal opportunity to present his invention in the marketplace with patent protection despite the fact that Mr. Charles H. Duell, Director of the Patent Office, declared in 1899, "***Everything that can be invented has been invented.***"

On Wednesday, August 20, 1986 at a news conference in Jackson, Mississippi, Joseph Newman demonstrated the practicality of a revolutionary electromagnetic lifting and motion device for Earth and Space travel. He demonstrated — contrary to conventional scientific teaching — that the electromagnetic effect occurring between objects can be made to **consistently repel** regardless of whether a magnetic entity has its poles reversed or whether the current in a conductor is reversed. Dr. Hastings testified to

the extreme significance of such an electromagnetic display and said "such a demonstration can be visually viewed by everyone, and it either works or it doesn't." In his Declaration of August 22, 1986, Dr. Hastings wrote: "The levitation experiment demonstrated a vertical force exceeding the force of gravity on strands of #40 copper wire when a few hundred milliamps were applied."

Despite the fact that Joseph Newman has repeatedly demonstrated the efficacy of his invention, has over 30 scientists who have tested and endorsed his invention, and has the endorsement of a technical expert to the Court and former Patent Office commissioner — our government is still denying Mr. Newman a patent at a cost of thousands of dollars to the taxpayer!

As of this writing, Joseph Newman is endeavoring to work on a motor capable of powering an automobile and is in the process of forming and financing (based upon foreign support) a manufacturing, research, and development corporation.

In conclusion, Joseph Newman wishes to express his gratitude to the thousands of people who have written and have called to show their encouragement and support. Such support is needed if this invention is to become a reality to benefit the people of this country and the world. And such support is necessary to overcome the same bureaucratic opposition to innovation that has throughout history impeded the progress of knowledge.

As Max Planck said: "A new scientific truth does not triumph by convincing its opponents and making them see the light, but rather because its opponents eventually die, and a new generation grows up that is familiar with it."

With all due respect to Max Planck, let's prove his prognosis incorrect in this case, and work to ensure the application and expansion of "an invention whose time has come." **Thank you for your continuing support!**

Saturday, April 12, 1986 The Times-Picayune/The States-Item

METRO NEWS

Energy Machine wows crowd at Superdome

By MICHAEL PERLSTEIN
Staff writer

Mississippi inventor Joseph Newman brought his Energy Machine to the Superdome Friday to convince the public of something he's been trying to get the U.S. Patent Office to believe for 20 years: that the device can produce unlimited amounts of energy for free.

More than 1,500 people paid \$1 admission to see the machine Friday, the first day of a week of demonstrations.

They came from as near as Houma and as far as Switzerland and South Africa, and many said they were convinced Newman's invention will work.

But the U.S. Trademark and Patent Office has not been nearly as sympathetic. Officials have repeatedly told Newman that his claims are impossible, and they have refused his request for a patent.

However, physicists and engineers who once scoffed at Newman's ambitious ideas spoke Friday in his behalf.

Newman claims the machine swallows energy from any power source and generates up to 14 times as much, without polluting.

The Lucedale, Miss., inventor claims he has discovered the principle of magnetic energy, a puzzle that still baffles physicists, and uses it to create electricity.

"I challenge any Ph.D. to get up on the stage and debate with me and prove me wrong," he said.

There were no takers, and many in the audience said they believed him.

Victor Melillo traveled from Cherry Hill, N.J. to see the machine.

"This machine is the greatest thing ever to happen to mankind," Melillo said. "What the

patent office is putting this man through is a travesty."

Cindy Dickinson of Atlanta admitted she didn't really understand Newman's ideas but thinks "it's crucial to get this to the people. If this machine works the people deserve to know what the government is keeping from them."

Stanley Higgins of New Orleans said, "If what he says is true, this is the biggest thing that's ever happened. How can you miss that when you live only 20 minutes away?"

20th September 85

9-20-85

DISCLOSURE DOCUMENTJoseph R. Newman
Dr. Conrad von Helldorf D.C.

On September 19 and 20, 1985 Joseph Newman disclosed and demonstrated to me his 130 pound motor with reciprocating magnet armature, operating with high voltage input. The primary problem which has been encountered in the past with scaling the Newman motors to large and practical output power levels was the need to go to higher voltage input, and the destruction which occurred when the coil was switched at high voltages. Joe has now solved the high voltage switching problem with a new commutator design, and it appears that arbitrarily high input voltages can now be reached.

The significance of high voltage on the Newman motor is that our data show that 1.) the output power increases as the square of the input voltage; 2.) the input power increases linearly with the voltage; 3.) the motor efficiency increases linearly with the voltage; 4.) output power levels required, for example, to power a home will require input voltages estimated at ten to twenty kilovolts.

On September 19, 1985 the motor was operated at 1,000 and 2,000 volts battery input, with output powers of 50 and 200 Watts respectively. Input power in these tests were 7 and 14 Watts, yielding efficiencies of 700% and 1,400% respectively.

In addition, the motor was operated for the first time using a high voltage transformer plugged into the a.c. power socket. The transformer output voltage was roughly 2,000 volts. The input power was readily measured using an a.c. milliammeter to be 25 Watts, while the output was measured again at approximately 200 Watts. The higher input in this case reflects the inefficiency of the transformer.

It now appears to me that the Newman motor can be readily scaled to power levels which will make it practical for commercial and home energy needs, and this should be accomplished in the very near future.

The above statements are true and accurate to the best of my knowledge.

Roger Hastings 9-20-85
ROGER HASTINGS, Ph.D.

DECLARATION CONCERNING JOSEPH NEWMAN MOTOR PROTOTYPE

On June 11, 1986 I witnessed a demonstration of Joseph Newman's latest motor prototype in Atlanta, Georgia. Newman's motor weighed about ten pounds, consisting of copper and a powerful magnet rotor. The rotor was attached to a 15 inch fan blade taken from a commercial fan. Newman's motor turned the fan blade at approximately 660 r.p.m.. It was connected through a mechanical commutator to 2500 volts of dry cell batteries. The d.c. input current was 1.8 mA, for a total power input of 4.5 Watts.

Also displayed was a commercial fan with a five inch blade. This fan was advertised as an energy saving motor. Examination of the motor revealed a precision motor design. It drew 25 Watts in operation. Newman's motor was obviously doing several times the work of the commercial motor, while drawing 5.5 times less power. A later experiment was performed in Mississippi in which a commercial fan with an identical 15 inch blade was powered from a Variac and run at the same speed as the Newman motor. The commercial fan drew 30 Watts compared to Newman's 4.5 Watts. It should also be noted that a 15 Watt flourescent tube, connected across Newman's motor coil to prevent sparking, was simultaneously lit to perhaps one fourth of its full brightness. Also, as in past prototypes, a large negative current (r.f. envelope) flows back into the battery from the motor coil.

My testing, and observations of Newman prototypes which are electronically commutated, indicate that Newman's fan prototype can be improved to run on external input of about 2 Watts. Thus further development can lead to a fan motor which consumes 1/15th the power of an efficiently designed commercial motor.

This result is significant in view of Mr. Newman's announcement of his intention to build an automobile motor prototype. I firmly believe that the above quoted results will scale up, and that Mr. Newman's car will consume at least 15 times less energy than present commercial electric cars. This energy savings could be utilized for any combination of longer running time, higher speed, or larger vehicle compared to present designs. Newman's car motor will operate on high voltage, will have high torque at low current, and will probably consume a fraction of one horsepower. If such a motor powered our nation's cars, air pollution would be greatly reduced, and the nation would become energy independent.

I swear that the above statements are true and accurate to the best of my knowledge.

Roger Hastings, Ph.D.

*Subscribed and sworn before me
this 20th day of June, 1986
G. J. Dennis*

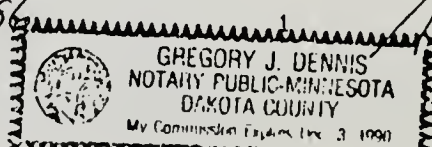

Roger Hastings

7-4-86
1204 Circle High Dr.
Burnsville, Mn. 55337

AN EVALUATION OF N.B.S. TESTING OF THE NEWMAN MOTOR

I have read and evaluated the Newman motor test results reported by R.E. Hebner, G.N. Stenbakken, and D.L. Hillhouse in National Bureau of Standards report #NBSIR 86-3405. While the reporters display fine credentials and demonstrate the use of precision equipment, they obviously did not test the Newman motor. Instead they measured the power consumed in resistors placed in parallel with the Newman motor, and called this power the motor output. In layman's terms, this is equivalent to stating that the output of an electric motor plugged into a wall socket is given by the power used by a lightbulb in the next room which is on a parallel circuit. The measurement of power consumed by these parallel resistors is clearly irrelevant to the efficiency of the Newman motor. The actual input power to the Newman motor (battery input minus power consumed by their resistors) is referred to in the report as "internal losses." No attempt was made to measure the mechanical output of the Newman motor. Nor was any measurement made of heat generated in the motor windings.

It has been demonstrated by myself and others that much of the excess energy generated in the Newman machine occurs at very high frequencies (in particular between 10 and 20 MHz). It has also been demonstrated that the high frequency current will flow to ground if given the opportunity. If Newman's machine is grounded through a high resistance, heat will be produced in the resistor which represents an additional motor output. In the N.B.S. testing, the Newman motor was connected directly to ground, thus eliminating the excess r.f. power from the system. The report states that "the power flow in the device is primarily a low frequency phenomena." This result was guaranteed by the test set-up. Again, the oscillographs shown on page 3 of the report show clean low frequency waveforms. All oscilloscope waveforms which I have observed on Newman motors which are properly connected have by contrast been dominated by extremely large high-frequency components.

In conclusion, the N.B.S. failed to measure the output of the Newman motor, and instead measured the output of parallel resistors. In addition, the primary r.f. energy generated by the machine was shunted to ground. Their measurements are therefore irrelevant to the actual functioning of the Newman device. These results reflect a total lack of communication between the N.B.S. and Newman or any other expert on Newman's technology. Considering the importance of Newman's Machine and its potential applications, this waste of N.B.S. resources and misrepresentation of Newman's device is an insult to those seriously interested in the machine and to those who may benefit by its future applications.



Roger Hastings, Ph.D.

**STATEMENT OF JOSEPH NEWMAN
BEFORE THE U.S. SENATE SUBCOMMITTEE ON
ENERGY, NUCLEAR PROLIFERATION AND GOVERNMENT PROCESSES
DATED JULY 30, 1986**

Good morning. Thank you for inviting me to appear today. My name is Joe Newman. I come here today from Lucedale, Mississippi. It may be in the backwoods. But that doesn't mean we are backward. No more than any other out-of-the-way place, like, say Kitty Hawk. I am an inventor. That is how I make my living and, in the course of making my living, I have obtained patents for a number of devices and machines. None, however, have been as dramatic as the one I've been fighting to patent for the last seven years.

I have invented a machine which uses the properties of magnetism and electricity to generate power. The reason my machine is a technological breakthrough is that my machine creates more external output energy than the amount of external input energy required to run it. My prototype is powered only by dry cell batteries. Various tests run by independent scientists have shown this machine can obtain efficiencies greater than 1000%. That means we have proven my machine can release more than ten times the energy than it takes to start it. The technology itself shows my device can produce much more than that. Think of the practical application of my machine to power your home, your car, or any other use that requires energy.

The thing that surprised me is that instead of being greeted by the Executive Branch and the Patent Office with curiosity and searching inquiries, I was greeted instead with incompetence, inconsistency, obstruction and worse. In the bargain some misleading impressions have been given some currency.

Firstly, my device does not — as some say — create energy. It releases available unused energy.

Secondly, I do not claim my machine is a perpetual motion machine as the Patent Office falsely and repeatedly says. Far from it. Through more than 21 years of hard work I have harnessed the properties of magnetism in a new way to obtain the unprecedented efficiency I've described. I do not claim my machine runs forever. I only claim it runs longer than any other motor or generator invented thus far.

Thirdly, I have proof for what I have to say. Thirty independent scientists including a principal physicist for Sperry Univac, Roger Hastings, with me here today, and Milton Everett of the State of Mississippi Geology Department, also present, have submitted sworn affidavits stating my machine works. My proofs persuaded no less than a former Commissioner of the Patent Office that my device works as I claim. This former Commissioner, Major William Schuyler, with an electrical engineering background, nominated by the Patent Office, not by me, was appointed by Federal Judge Thomas Jackson on his own motion, over my objection, to render an opinion for this Judge. Major Schuyler, who bears the title of Special Master, concluded that there was overwhelming evidence that my machine works. More than that, this former Commissioner stated there was no contradictory evidence and that the Patent Office had knowingly not followed patent law and that the Patent Office's position that the machine was impossible was "clearly erroneous" and that they were overruled, and that the patent should issue if the applicant met the balance of the patent statute.

My counsel, John Flannery, has provided you with additional details. But let me add a few comments. I filed my first patent application on March 22, 1979 — more than seven years ago. Since then the Patent Office has done nothing but throw up barriers to block me from obtaining a patent. However, I assembled the proof I've discussed that my machine works. I also complied with the Patent Office's other requirements. There is no question that my device is new or that it works. More than 30 credible scientists have listened to my technical process and ran their own tests and put their hard-earned reputations on the line to state that my device works. The Special Master gave those courageous individuals their due by stating the evidence before the Court and the Patent Office was overwhelming that the invention worked as I claimed it did.

Since 1979, I have suffered eight different rejections by the Patent Office. Dealing with the Patent Office is like having a starring role in the movie CATCH 22. I have had a trial scheduled on three different dates: June 1984, February 1986, and now December 1986. I'm not sure I'll ever get a trial. And then my counsel tells me there is the appeal. Even when I get a Court of Appeals Order disciplining the lower Court, it is ignored by the lower Court, the N.B.S., and the Patent Office. The N.B.S. has just run these tests behind closed doors, and they did it wrong as Roger [Hastings] shall tell you in a moment and they expect me to pay for it — \$75,000. Imagine that. That's not fair. That's why I've turned to you as the representatives of the people, my Mississippi neighbors and others across this nation, who I believe want to give me a chance to succeed (or even to fail).

Please try to understand my frustration as an inventor who believes he has a new way to generate power.

Benjamin Franklin said:

“There are everywhere a number of people who, being totally destitute of any inventive faculty themselves do not readily conceive that others may possess it.”

Franklin and others saw the power granted to Congress as a protection for such individuals. That promise of protection has been withheld in recent years from me — and others.

I have proven my machine works. I believe I am entitled to a pioneering patent as dictated by the guidelines of the Supreme Court. I appealed to the Patent Office to accept my proofs, to acknowledge my submission was “new” and to grant my pioneering patent so my pioneering invention could benefit others. Instead, they turned a deaf ear, disregarded their own procedures, knowingly and consistently violated patent and federal law, and the Courts have equally condoned this injustice. That is why I have turned to you on behalf of myself and all inventors and citizens who believe the purpose of the patent system is to promote, not stifle, inventors because the jewel of our civilization is our creative people. Stop creativity and one stays the advancement of the human race. That is why I ask you Senators to give me the relief I’ve fought so long to obtain. If I have what I claim, no one loses. If I’m dead wrong, and I tell you with all my heart and soul I’m not, then no one loses for I shall fade from sight. But I’m right and I ask you to give me the chance to prove it in the marketplace, to grant me a pioneering patent.

Thank you again for your attention and this opportunity.

**STATEMENT OF ROGER HASTINGS, Ph.D.
BEFORE THE U.S. SENATE SUBCOMMITTEE ON
ENERGY, NUCLEAR PROLIFERATION AND GOVERNMENT PROCESSES
DATED JULY 30, 1986**

My name is Roger Hastings. Thank you for the opportunity to address this Committee. Before I discuss Mr. Newman’s device, let me tell you something about my background, how long I’ve know Joe Newman, and then I’ll make my observations about Newman’s device, and repeat my criticism of the recent N.B.S. tests of Newman’s device.

I. BACKGROUND

My education, through the Ph.D., is in physics. I have served as a Professor of physics for four years, and for the past five years I have worked as a physicist for the Sperry Corporation in St. Paul, Minnesota. My current title is Senior Staff Scientist, and I am the manager of Sperry’s Superconductive Electronics Technology Center. I have known Mr. Joseph Newman for five years. During this time I have tested most of the many prototype motors which he has constructed, and I have witnessed testing by other technical people. I have become familiar with Mr. Newman’s theories and attitudes. I represent myself in this matter, and have never represented Sperry Corp. regarding Mr. Newman or his machine.

II. NEWMAN’S DEVICE

Newman’s motors all consist of a very powerful permanent magnet which rotates or reciprocates within or near a coil consisting of a very large number of turns of copper wire. The coil is energized by a battery pack, and the magnetic field produced by the coil provides the torque or force required to rotate or reciprocate the permanent magnet. A mechanical commutator reverses the direction of current flow through the coil each half cycle, and in some models also chops the current input between current reversals. Technically, the motor may be described as a two pole, single phase, permanent magnet armature, d.c. motor. The difference between Newman’s design and the prior art is one of scale: very large magnet and very large coil. Newman’s large motors contain conventional ceramic magnets weighing up to 700 pounds. His smaller motors use powerful rare earth magnets. The coils typically are wound with more than 100,000 turns of copper wire. Since the coil resistance is therefore high, the machines operate on battery voltage which is sufficiently high (hundreds to thousands of volts).

The torque applied to the magnet in these motors is proportional to the product of the strength of the magnet, the number of turns of copper wire, and the current flowing through the wire. In Newman’s machines extremely large torques can be developed with very small current inputs. If we scale up Newman’s motor, it is theoretically possible to obtain infinite torques with infinitesimal current flow (and not violate any laws of physics). However, according to conventional thought, as soon as this magnet begins to rotate, doing work against some load applied to its shaft, the back emf (electromotive force) produced by the rotating magnet would produce a back current which nearly cancels the input current, and the torque would be reduced to nearly zero. The magnet could not rotate, or would rotate extremely slowly with the shaft power output less than the battery input.

Consider what has happened to conventional thought in the past when people have experimented with the limits of very high speeds (relativity), very small dimensions (quantum mechanics), very low temperatures (superconductivity and superfluidity). Newman's motors probe the limits of very large torque with very small current input. And they do rotate at relatively high rates. For example, witness Newman's latest prototype (on demonstration following this hearing today in an auditorium in this building) which runs on 0.0008 amps at 3000 volts and turns a 16 inch fan blade at more than 500 r.p.m. How much torque can this motor produce? Try to stop the motor by holding the two inch diameter shaft. This will not be possible for a normal human, although the motor is a scale model of a motor which Newman intends to build to power an automobile.

Newman's motors are unconventional in other ways. One notices the fluorescent tubes which are placed across the motor coil. These tubes are lit by the coil's collapsing magnetic field occurring when the battery voltage is switched. They are used to protect the mechanical switch from damage due to arcing. The additional power produced in these tubes (and flowing through the system) occurs at very high frequencies, primarily in the range of ten to twenty million cycles per second. This r.f. (radio frequency) current has been accurately measured, and exceeds the battery input current by factor of five to ten in the various motors. One of Newman's motors was monitored with a computerized high speed data sampling system, with the following results:

- (1) The r.f. appears in bursts, with the repeat time between each burst approximately equal to the length of the motor winding divided by the speed of light in copper. The r.f. bursts showed little attenuation during their travel through the coil, maintaining their shape and amplitude.**
- (2) The r.f. current and voltage were in phase, representing the real power.**
- (3) The r.f. current and voltage waveforms were offset from ground, indicating a net d.c. component.**
- (4) The net r.f. power at the battery pack represented a negative power which exceeded the d.c. input power from the batteries.**

The last statement may explain why Newman has been able to demonstrate the charging of dry cell batteries placed in his system. Battery failure has occurred through internal shorts which develop within the batteries rather than by depletion of the energy stored within the batteries. When you witness the demonstration of Newman's latest prototype, if you attend the demonstration following this hearing, bear in mind that the batteries will last many times longer than expected for a drain of 0.0008 amps. A prominent battery company is working with Newman to develop batteries which will stand up to the r.f. power levels, and perhaps last even longer.

Newman's motor design is based on his theory of gyroscopic particles which he explains in his book "The Energy Machine of Joseph Newman." Full utilization of his machine will require a detailed mathematical representation of the phenomena based on a thorough understanding of the atomic processes at work. This will require a parallel program of experimentation using the finest resources available. Application programs have already been conceived (for example, the car motor), and will require prototyping and manufacturing efforts. Newman should be immediately awarded a patent and become recognized in the scientific community for his accomplishments to date.

III. AN EVALUATION OF N.B.S. TESTING

I have been asked whether the recent N.B.S. tests alter the opinions I've expressed before and I'm repeating here today. The recent N.B.S. tests don't alter my opinion because N.B.S. failed to test Newman's device.

I have read and evaluated the Newman motor test results reported by R.E. Hebner, G.N. Stenbakken, and D.L. Hillhouse in National Bureau of Standards Report #NBSIR 86-3405. [See "Report of Tests on Joseph Newman's Device," U.S. Dept. of Commerce, dated June 26, 1986, hereinafter referred to as "the NBS Rpt. at ____."]

A. N.B.S.'s Energy "Output" Measurements

While the reporters display fine credentials and demonstrate the use of precision equipment, they obviously did not test the Newman motor. Instead they measured the power consumed in resistors placed in parallel with the Newman motor, and called this power the motor output. [See NBS Rpt. at 7 (Fig. 4.) "Schematic Drawing of Newman device and input and output power measurements circuits," reproduced with comments plainly referring to the "Resistors" as such in the accompanying chart.]

In layman's terms, this is equivalent to stating that the output of an electric motor plugged into a wall socket is given by the power used by a lightbulb in the next room which is on a parallel circuit. The measurement of power consumed by these parallel resistors is clearly irrelevant to the efficiency of the Newman motor.

The actual input power to the Newman motor (battery input minus power consumed by their resistors) is referred to in the report as "internal losses." No attempt was made to measure the mechanical output of the Newman motor. Nor was any measurement made of heat generated in the motor windings.

B. The Additional Energy N.B.S. Lost From The System

It has been demonstrated by myself and others that much of the excess energy generated in the Newman machine occurs at very high frequencies (in particular between 10 and 20 MHz). It has also been demonstrated that the high frequency current will flow to the ground if given the opportunity. If Newman's machine is grounded through a high resistance, heat will be produced in the resistor which represents an additional motor output. In the N.B.S. testing, the Newman motor was connected directly to ground, thus eliminating the excess r.f. power from the system [See NBS Rpt. at 7 (Fig. 4.) "Schematic Drawing of Newman device and input and output power measurement circuits," reproduced with comments plainly referring to the "Ground" as such in the accompanying chart.] The report states that "the power flow in the device is primarily a low frequency phenomena." This result was guaranteed by the test set up. Again, the oscillographs shown on page 3 of the report show clean low frequency waveforms. All oscilloscope waveforms which I have observed on Newman motors which are properly connected have by contrast been dominated by extremely large high frequency components.

C. Conclusion

In conclusion, the N.B.S. failed to measure the output of the Newman motor, and instead measured the output of parallel resistors. In addition, the primary r.f. energy generated by the machine was shunted to ground. Their measurements are therefore irrelevant to the actual functioning of the Newman device. These results reflect a total lack of communication between the N.B.S. and Newman or any other expert on Newman's technology. Considering the importance of Newman's machine and its potential applications, this waste of N.B.S. resources and misrepresentation of Newman's device is an insult to those seriously interested in the machine and to those who may benefit by its future applications.

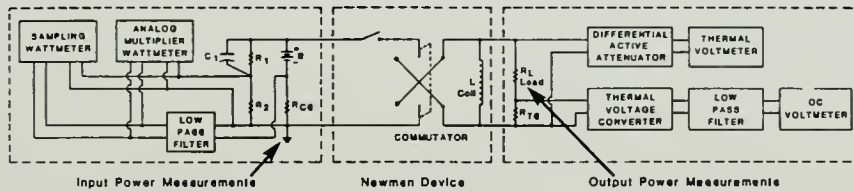

GROUND (NBS shunted energy from Newman device to ground without measuring and lost it.)

RESISTORS (NBS measured energy spent in resistors but not in or by Newman's Device.)

Prof. Hastings:

"In the NBS testing the Newman motor was connected directly to ground, thus eliminating the excess r.f. power from the system."

Prof. Hastings:

"... This is equivalent to stating that the output of an electric motor plugged into a wall socket is given by the power used by a lightbulb in the next room which is on a parallel circuit."

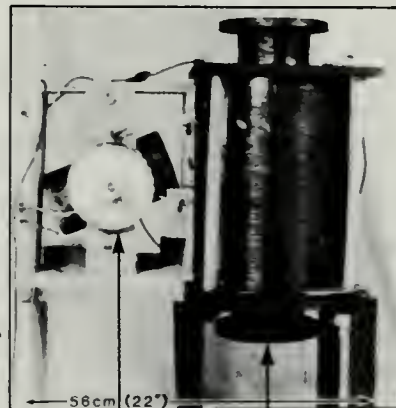

COMMUTATOR COIL

Principal points concerning deficiencies of the NBS test conducted by three individuals:

- 1) The input voltage into the energy machine was restricted. This is exactly opposite to the Technical Process taught by Joseph Newman who teaches that the input voltage should be maximized and the input current should be minimized. The three individuals at the NBS did the opposite.
- 2) As Dr. Roger Hastings wrote in his statement: "In the NBS testing, the Newman motor was connected directly to ground." — as a result, the excess output power was shunted away.
- 3) The NBS tests did not measure the output of Newman's motor — instead, he says, the tests measured the output of parallel resistors. As a result, Dr. Hastings says, "Their measurements are therefore irrelevant to the actual functioning of the Newman device."
- 4) No attempt was made to measure the mechanical output of the Newman motor — only the electrical output.
- 5) No attempt was made to measure the heat generated in the motor windings.

STATEMENT OF JOHN P. FLANNERY, III
BEFORE THE U.S. SENATE SUBCOMMITTEE ON
ENERGY, NUCLEAR PROLIFERATION AND GOVERNMENT PROCESSES
DATED JULY 30, 1986

Thank you Mr. Chairman and the members of this subcommittee for inviting us here today to discuss how the Patent Office has failed to treat fairly or to protect, as is merited, the device backwoods inventor Joseph Newman has invented.

I represent Joseph Newman. I am his counsel.

I represent just one inventor, among many, who has spent his resources fighting a tangled bureaucracy, rather than devoting himself exclusively to his work.

Mr. Newman, 49, seeks a patent denied him for six years not because of Patent Office bungling (they ignored their own procedures), incompetence (the patent examiner who rejected his patent application admittedly doesn't have a college level understanding of physics), bad faith (the Patent Office's Deputy Solicitor filed an admittedly false sworn declaration, later recanted, knowing it was false in a desperate effort to rebut Newman), unlawfulness (former Commissioner Mossinghoff misappropriated \$100,000 of federal energy monies to discredit Newman by an irregular and unprecedented testing procedure just before Mossinghoff resigned the Patent Office in December, 1984) contemptible and unfair (the Patent Office's expert, the National Bureau of Standards, ran tests behind closed doors in violation of a Court of Appeals Order requiring them to give notice of the tests they intended to run and to complete the tests within thirty days; they did neither).

The U.S. District Court has confessed its technical incompetence, ignored the findings of the Special Master it appointed, seized inventor Newman's property without notice or hearing, and defied the plain language of a writ issued by the Court of Appeals to correct the District Court's "highly irregular" procedures.

As a result of what the executive and judicial branches have done (and what they have failed to do), this, the legislative branch of government has responded by introducing private legislation in the House that might accomplish what Newman has otherwise been unable to obtain and provided us this hearing in the Senate. We hope that this hearing shall result in the Senate introducing private legislation so that Joe Newman may finally have a fair shot at the marketplace. Again, we thank you for this opportunity.

As you may know, there has been a great deal of media coverage of Mr. Newman's case including magazines like **REGARDIE'S**, local and national newspapers and wire services such as **ABC WEEKEND NEWS**, **CNN**, and even Johnny Carson's **TONIGHT SHOW**. But I thought I might serve this Committee best by summarizing the facts of this case.

I. THE FACTS

A. The Patent Office

What's happened is simple and tragic. Newman holds a number of patents and, in 1980, he applied for another one. But the Patent Office was entirely unable to understand — at least so they could claim at the outset — Newman's claim that his device produced more energy out than required to run it.

The Patent Office said you can't do that, that is, get more energy out than you put in. They were, however, dead wrong. Newman's notion is just like what occurs when you strike a match to dry wood; you release more energy from the wood (the fire) than the energy required to get it going (the match). The only difference is that Newman's device doesn't release stored chemical energy (due to photosynthesis) but stored electromagnetic energy (due to permanent and induced magnetic fields).

In 1980, Newman built a prototype proving his device operated. But the Patent Office refused Newman's offer to test it. More recently, they have been somewhat eager to test it but only on their own schedule, without describing the tests beforehand, and only if the public is excluded during the tests. In essence, they refused to test Newman's device fairly, and under circumstances that Newman could afford to attend, and have otherwise defied an appellate court order directing them how to proceed — but more about that shortly.

The Patent Office ignored the sworn statements of 30 scientists and engineers, including a principal physicist for Sperry Corp., Dr. Roger Hastings, that Newman's device operates as he claims.

In one earlier affidavit by Dr. Hastings, based on several experiments he ran, he found:

- (a) for the **same input power**, Newman's motor ran *seven hours* as compared with an 80% rated efficient D.C. motor that ran only *six minutes*,
- (b) batteries run down so that they were **unable to power** even a 1 ½ -volt *toy motor*, when connected to Newman's device, not only turned Newman's 90 pound rotor, but even caused it to *accelerate within only 20 seconds*, and
- (c) Newman's device — in 1982 — measured **unprecedented efficiencies** of 800% (output/input).

B. The Court

In January, 1983, Newman filed a suit in federal district court in the District of Columbia asking the Court, as is provided for by statute, 35 United States Code, Section 145, to compel the Commissioner to issue him a patent as the Patent Office had refused him one. The case was assigned to U.S. District Judge Thomas Penfield Jackson, appointed to the bench in 1982.

This case was first set down for trial in June 1984. But Judge Thomas P. Jackson said he was incompetent, technically incompetent, to consider the matter, and appointed a Special Master, proposed by the Patent Commissioner, over Newman's objection, to determine if Newman's device operated. The Master, former Patent Commissioner William Schuyler (an electrical engineer), reviewed all the evidence and concluded: (1) there was "overwhelming evidence," without contradiction, that Newman's device operated as claimed, (2) that one "skilled in the art" could make or use Newman's device, (3) that the Patent Office had disregarded its own procedures in denying Newman a patent, (4) that the Board of Patent Appeals decision that Newman's device was impossible was "clearly erroneous" and, (5) as a matter of law, a patent should issue.

Rule 53 of the Federal Rules of Civil Procedure provides that the Judge "shall accept the findings" of the Special Master, but the Court did not. No more technically competent than when the Court appointed the Master, the Judge set aside the Master's findings citing a body of scientific knowledge that he admitted was beyond his comprehension. Judge Jackson also ordered Newman to pay for the Master's services and expenses; so this exercise cost Newman about \$12,000.00.

In December 1984, Commissioner Mossinghoff arranged to have \$100,000.00 of Energy Act funds misappropriated to discredit Newman's device. Commissioner Mossinghoff made an unprecedented agreement with the National Bureau of Standards. He ran little risk as he already had N.B.S. expert Jacob Rabinow file a sworn declaration that Newman's device did not operate. So the Patent Office ran little risk of the N.B.S. contradicting itself with tests.

We believed as part of pre-trial discovery that they were entitled to prepare their defense but we wanted to know what they were doing so we could defend against their critical claims at trial. It was not reassuring that the supposed national laboratory, the N.B.S., had already said the device didn't operate without ever testing it. Nor was it reassuring that this same N.B.S. expert Rabinow sat in on the meeting when the Patent Office struck this agreement with its sister agency, the N.B.S.

Thus did we insist on five safeguards: (1) presence (we be there so we could keep an eye on what the Patent Office and N.B.S. were doing), (2) a limitation on the duration of the test (so that presence was affordable to Newman, his counsel and an expert), (3) destruction (there be none because Newman develops and demonstrates his prototypes and, if the device was destroyed, how could we contradict the results they claimed), (4) that the Patent Office describe in advance the tests they intended to run, and (5) N.B.S. report the results of any "test" they did run.

Commissioner Quigg rejected these conditions out of hand. He asked the Court to order Newman to surrender his device, to exclude Newman from "preliminary tests" — whatever they were — and to permit N.B.S. to destroy the device; the Patent Office made the astonishing admission in a letter to Representative Trent Lott that they wouldn't say Newman's device operates until after they had destroyed it. The N.B.S. expert Hebner said the same thing in a sworn declaration.

Judge Jackson obliged the Patent Commissioner and issued the Order as requested.

In October 1985, as I asked the Court of Appeals to stay the extraordinary Order, particularly as Newman would suffer irreparable harm if he was forced to comply. The Court of Appeals issued the stay.

I also asked the Court of Appeals to take the extraordinary step of issuing a Writ of Mandamus.

On January 13, 1986, the Court of Appeals did. The Circuit Court sternly rebuked District Court Judge Thomas P. Jackson for his unprecedented, "highly irregular," and fundamentally unfair procedures. *In Re Newman*, 782 F.2d 971, 974-75 (Fed. Cir. 1986).

The Appellate Court also ordered the safeguards we requested. They said we could be present for all tests, N.B.S. had to tell us what tests they were going to run in advance. They had thirty days, that's all, to run the tests and issue a report. Newman thought he finally had the level playing field he fought for six months to obtain. But as you will see, the N.B.S. and the Patent Office ignored the court-ordered safeguards from the moment Newman timely produced his device on January 24, 1986.

C. The National Bureau of Standards

N.B.S. refused to run a single test unless they were permitted to destroy Newman's device. They told the Court of Appeals before they ran the test, that Newman's device was a hoax. N.B.S. came up with a thousand excuses, each of which Newman answered, to run the clock while they waited for permission to destroy Newman's device. For example, they insisted on communicating by mail, rather than by phone. In another instance, they required Newman to travel 1,000 miles from Mississippi to Maryland to move a wire a single inch. Newman and I told N.B.S. they could connect it. But they insisted Newman do it. Even after Newman did, after he traveled a thousand miles to do it, they refused to test Newman's device or even to tell him when or how they would test it.

The Patent Office and the N.B.S. kept Newman's device for thirty days without running a single test. During that time, the Federal Circuit reaffirmed its decision refusing to let the Patent Office or N.B.S. destroy Newman's device; they issued an unreported Opinion on February 12, 1986. But the Court of Appeals Order made not a bit of difference. The N.B.S. didn't describe or run a single test in the thirty days they were given to do so. On several occasions they asked us to tell them how to run the tests. We refused to tell, although we did tell them how we had run past tests. It is of critical importance that we told them **not** to connect the device to ground.

On February 24, 1986, when the thirty days that the Court of Appeals allotted ran out, without a single test having been described or conducted, I went to pick up Newman's device with the knowledge and consent of National Bureau of Standards Deputy Director Kramer.

But before I could retrieve the device, the Court seized it without prior notice, much less any hearing. Upon arriving at N.B.S. to retrieve the device, I was told that the Court had summoned me to court threatening my arrest if I did not appear in court within the hour. Upon arriving in the court, I was ordered, under penalty of contempt, not to retrieve my client's property. We objected but complied with the Court's order.

On March 3, 1986, as a result of the Court's questionable procedures, Mr. Newman made an affidavit in support of a motion to disqualify the sitting District Judge for his demonstrated personal bias and prejudice.

On March 7, 1986, the District Court held a status conference to consider giving the Patent Commissioner's expert more time to test Joseph Newman's device beyond the thirty days authorized by the U.S. Court of Appeals. *In Re Newman, supra*, at 975.

Immediately before the status conference began, the Judge's law clerk handed me an order denying Newman's motion to disqualify the Judge as insufficient, but without any discussion as to why the pleadings were factually insufficient. The Judge held me in contempt for merely mentioning our pending motion to disqualify him. During that same hearing the Court allowed the Patent Office to continue to have Newman's device and to test it, day to day, until June 26, 1986 — 150 days after Joseph Newman produced the device for testing.

Newman could not afford to be present with counsel and an expert for the 12 hour work-days N.B.S. claimed they worked each day. It would have cost Newman about \$60,000, or more, to attend the tests. Former Patent Commissioner Mossinghoff misappropriated \$100,000.00 to run these unprecedented tests. The tests, we have been told, cost about \$75,000.00. Sure Newman technically had a right to attend the tests, but it was a right he could not afford to exercise. He is not a large corporation. He is an inventor who lives by what he invents. Worse, the Patent Office earlier said they expect Newman to reimburse the Patent Office for what the tests cost.

On June 26, 1986, the Patent Office's expert finally issued its report. Unsurprisingly, the N.B.S. said Newman's device did not operate as Newman claims it does. It is ironic that as a consequence of the Patent Office's disregard of the Court of Appeals requirement that the N.B.S. notify us what tests they intended to run during the 30-day test period authorized by the U.S. Court of Appeals, Newman did not know until **after** N.B.S. issued its report how N.B.S. "tested" his device. Only afterwards did Newman discover that the N.B.S. did not test his device at all.

Professor Hastings will say more about this, but, as I said earlier, before N.B.S. ran any tests, I forwarded to N.B.S. a schematic of the circuit used to test Newman's device. It plainly showed not to connect Newman's device to ground. But N.B.S. nevertheless allowed energy to escape from the device, literally to the ground, and then measured the power spent in a load (resistors) wired in parallel to the device. Therefore, N.B.S. did not measure the energy produced in (or by) the device itself.

If the Patent Office and the N.B.S. had complied with the Court of Appeals Order, Newman would have had a second opportunity to reinforce what was already obvious from the schematic diagram forwarded to N.B.S., that they should not connect Newman's device to ground. We could have told N.B.S. they were in error. But as N.B.S. and the Patent Office failed to give us any notice — contrary to the Court of Appeals Order — of the tests they intended to run during the 30-day test period authorized by the Court of Appeals, they wasted Newman's resources and, by their estimates, \$75,000.00 of federal taxpayer's monies misappropriated by former Commissioner Mossinghoff.

D. The Congress

Newman's device never had a chance in the Patent Office. Nor has Newman gotten a fair shake from the District Court. Nor has the Court of Appeals Order compelled the Court, the Patent Office or N.B.S. to act fairly. The Patent Office continues to spend taxpayer's money in an effort to grind down Newman's resources if they can't otherwise fairly meet and contradict his arguments.

As Newman could not get his "day in court," I asked Congress to give Newman his "day in the marketplace." We respectfully repeat and renew that request today.

That is why Representative Dan Burton (R-Ind.) last October introduced H.R. 3590 on Newman's behalf. Joseph Newman seeks a pioneering patent. That is a patent for something that has not been done before. As the Patent Office claims Newman's device is impossible, but we have proved to the contrary, then it is a pioneering patent. The Supreme

Court has ruled on 6 occasions since the latter part of the 19th Century that such patents should be liberally interpreted from the narrowest to the widest to interpretation of the claims and as much as possible the claim language will be interpreted in the language of the applicant to uphold the fruits and labor of his genius. This is also why Representative Trent Lott abandoned his position that Newman should wait on the outcome of the litigation and last December introduced his own bill identical to H.R. 3590. More recently, Representatives Kindness, Torricelli, Dannemayer, Tauzin, Daub, Dowdy and Livingston introduced identical private bills. Representative Livingston has called for an investigation of the matter. The House of Representatives has not yet held its hearing, but you have. We are grateful for this opportunity.

II. CONCLUSION

Newman has stated before, as he shall again shortly, that he shall continue to press his case.

We respectfully request that after this hearing, after hearing what we've had to say, and after considering the evidence that the members of this Committee join and introduce a private pioneering patent bill in the Senate so that Joseph Newman may finally have a patent as protection for his work.

Thank you for your attention and, after Mr. Newman and the other members of this panel make their statements, we would all be glad to answer any questions you may have.

**STATEMENT OF MILTON EVERETT
BEFORE THE U.S. SENATE SUBCOMMITTEE ON
ENERGY, NUCLEAR PROLIFERATION AND GOVERNMENT PROCESSES
DATED JULY 30, 1986**

Thank you for inviting me to be here today. My name is Milton Everett and I am with the State of Mississippi Geology Department although I am appearing here today on my own behalf.

Throughout Mr. Newman's struggle, one thing that has struck me as astounding for an agency supposedly interested in science is the total absence of curiosity by the Patent Office.

My only direct contact with the Patent Office officials occurred when Mr. Jerry Sears, Solicitor for the Patent Office, attended my deposition at Mr. Newman's Lucedale, Mississippi home.

Mr. Sears assumed an adversarial, not an inquisitive attitude toward me and the others present. I do not believe this is a proper attitude for an official of the Patent Office.

Mr. Sears' travel expenses were billed to Mr. Newman and much to my amazement, he was neither interested in seeing or testing Mr. Newman's device.

It became evident in the course of the proceedings that his sole intention was to discredit all evidence in support of Joe Newman's patent.

What I had to say, I suppose, didn't suit his purposes. I testified about a water pumping test I had taken part in and in which I found the Newman device efficiency to be 10 times greater than the conventional electric motor. Indeed, the conventional motor's efficiency was about 40% which yields a Newman device efficiency of at least 400%.

I have submitted a number of statements in the three and one-half years I have known Joe Newman. I have attested to the numerous tests I've observed: mechanical tests, electrical tests, and thermal tests.

But let me tell you this. In each and every case where the Newman device has been properly tested, it has shown an efficiency of greater than 100% and I'd stake my professional reputation on that assertion.

XVI. ADDITIONAL ACKNOWLEDGMENT

To Dr. Nikolaos Tsoupas: an exceptional Physics Teacher, Research Scientist, and the very first teacher with a doctorate in Physics who cared enough to express in writing the immense importance of this invention to the "People" with the full knowledge that many of his colleagues — in a knee-jerk (unthinking and unquestioning) response — would disapprove.

To the alumni of the university who may be fortunate enough to have Dr. Tsoupas as a member of its faculty and especially to the students of that university who have a class or classes instructed by Dr. Tsoupas — be aware of the meaning and essence of the word "Teacher." The following courageous letter by Dr. Tsoupas says it all!

Joseph W. Newman

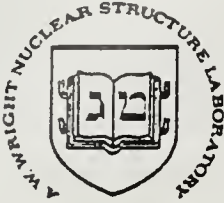

YALE UNIVERSITY

A. W. WRIGHT NUCLEAR STRUCTURE LABORATORY

P.O. Box 6666, 272 Whitney Avenue, New Haven, Connecticut 06511

Nov. 16, 1985

Representative Bruce A. Morrison
437 Cannon Bldg.
3rd Distict: Fairfield, Middlesex, New Haven Counties
House Judiciary Committee:
Washington, D.C. 20515

RE: H.R. Bill 3590

Dear Mr. Morrison:

I am writing on behalf of the Inventor Joseph Westley Newman of Lucedale, Mississippi, to urge you to support the special private bill H.R. 3590 introduced in the House of Representatives on October 17, 1985.

I am a resident of New Haven, Connecticut and work at Yale University as a Research Associate in the physics department, doing research in nuclear physics and also teaching physics at Yale University, and at times in Southern Connecticut State University and University of New Haven. As a scientist I consider myself open-minded and I welcome and support new ideas and inventions intended for the well being of the human race.

Mr. Newman has demonstrated many working models of his invention, an "energy machine" which is based on his own ideas. In spite of this earthshaking invention, the U.S. Patent Office has denied him a patent. I know for a fact that many scientists consider his invention unorthodox and unacceptable, possibly because his theories do not fully comport with today's University teachings. However, as Mr. Newman has demonstrated that his invention works the way he claims, the Patent Office should not have denied him a patent. This invention means an unlimited source of energy and will introduce new ideas into the science of physics.

I fully trust that you will support this bill and thus Mr. Newman will be able to devote more time to his inventions and in developing his energy machine for commercial uses, instead of draining his energy and financial resources by fighting the Patent Office personnel.

Sincerely,

Nikolaos Tsoupas

Nicholaos Tsoupas, Ph.D

NT/amt

XVII. The following was written in response to the introduction of Senate Bill S. 2832 by Senator Thad Cochran of Mississippi.

To whom it may concern:

Senator Thad Cochran is clearly taking a stand as an enemy to the people of the State of Mississippi, the country, and the world. He has now introduced Bill S. 2832 in which he seeks more testing of the energy machine of Joseph Newman and more unjust examination by the Patent Office. This unjust position of Senator Thad Cochran flies in the face of the direct order by both the Mississippi Senate and House which overwhelmingly stated that the Judicial System, Judge Thomas Penfield Jackson, and the Patent Office have failed to serve justice to Joseph Newman. The Mississippi Legislature also ordered that the Patent Office be forced to issue a patent to Joseph Newman.

This same position was also stated by the Republican Study Committee of Congress (Chaired by Congressman Bob Livingston of Louisiana), the City Council of New Orleans, the City Council of Lucedale, Mississippi, and by eleven different Congressmen who have introduced eleven Bills seeking to have Joseph Newman issued a patent for his pioneering invention. It was most properly stated by Congressman Wayne Dowdy of Mississippi when he said, "**If the Patent Office denies this country the benefits of what could be a revolutionary energy device, then its obstinancy would, in my mind, be criminal.**"

Senator Cochran has chosen to ignore my letter to him of August 27, 1986, in which I wrote:

"To ask for additional testing flies in the face of the clear, deliberate violation of the laws by the Patent Office and Federal Judge Thomas Penfield Jackson. These facts have been verified by the Republican Study Committee Report and both the Mississippi State House and Senate.

*"Relative to any institution or lab that does not presently have ties to receipt of funding or work contracts from the U.S. Government Agencies, I know of none, and I will agree to no testing where that government influence can or could be feasible. Nor will I agree to any testing procedure which will infer that the **criminal**, consistent injustice put forth by the Patent Office, Thomas Penfield Jackson, and the National Bureau of Standards was O.K.*

"My strong and unbending position is that anyone who condones these past injustices of the Patent Office, the National Bureau of Standards, and Thomas Penfield Jackson, is just as guilty as they."

Senator Thad Cochran's position also flies in the face of Joseph Newman's earnest and eager attempt to establish a Research, Development, and Manufacturing Company of his energy machine technology in the State of Mississippi. Such technology will create many new jobs and spur "a new Industrial Revolution which will flow from the State of Mississippi and spread across the world."

The facts clearly show that Senator Thad Cochran is an enemy of the people of the State of Mississippi and I, Joseph Newman, urge every resident in Mississippi to call, wire, or write Senator Cochran to inform him that he will not be elected in November of 1988, and that he cannot blatantly defy the will of the people of the State of Mississippi and of the State Legislature since the power of this State belongs to the people and **not** to Senator Thad Cochran.

Thank you.



Joseph W. Newman

U.S. SENATOR COCHRAN IGNORES THE MISSISSIPPI STATE LEGISLATURE AND SANCTIONS PATENT OFFICE MISCONDUCT AGAINST JOSEPH NEWMAN The Mississippi Legislature, sitting in extraordinary Session, resolved that Mississippi energy machine inventor Joseph Newman has suffered "arbitrary and unfair treatment" by the U.S. Patent Office and asked the Mississippi Congressional delegation in Washington to do something about it — to grant Newman a patent.

U.S. Senator Thad Cochran has ignored the State Legislature's request. Indeed, he's helping the Patent Office to make matters worse. Senator Cochran made the surprising admission on the floor of the U.S. Senate, even after holding hearings, that he couldn't figure out what the Patent Office did wrong. More than that, he said there "oughta be a law" to give them the opportunity to do it again and then he introduced a bill — S. 2832 — to make it possible for the Patent Office to do it again.

Where did the Senator go wrong?

During the Senate hearings Senator Cochran held in late July, it was clear that although his staff was familiar with the case, the Senator was not. Neither the Patent Office nor the National Bureau of Standards produced anyone to testify who had been involved in the case. The Senator's "searching inquiry" of the Patent Office witnesses who appeared consisted of "softball" questions such as, "Did the Patent Office disregard its procedures in the Newman case?" yielding the unsurprising response, "No, Senator." Newman said, "The Senator didn't seem to know anything about the case or even to care to know what happened although we certainly sent him sufficient background materials and my counsel briefed the Senator's staff a number of times. I guess the Senator was just going through the motions, you know, allowing me to speak my piece but never intending to do anything about it. That's what happens when you spend too much time too close to Washington. You get Potomac fever."

During the hearings, Senator Cochran asked whether Newman — who has just retrieved his device from the National Bureau of Standards after 150 days of testing — would submit his device for more testing elsewhere; the Patent Office has said they expect Newman to reimburse them for the \$100,000 they spent in trying to prove Newman's device didn't operate. Roger Hastings, a principal physicist with the Sperry Corporation, responded to the Senator's question that scientists always welcome more testing, but, as far as Newman's patent application went, that should not be linked with more testing. Newman has already demonstrated his device operated to the satisfaction of a former Patent Commissioner and Congress should direct that a patent issue to Newman without any more testing and further delay.

Despite the testimony by Mr. Newman, Dr. Hastings, and others, as well as the documents they submitted, Senator Cochran proposed legislation requiring Newman to select one of five universities for more testing of his device but, even if Newman agreed and the Universities agreed and then they enthusiastically endorsed Newman's device, Senator Cochran's bill **makes no demand of the Patent Office. It doesn't even require the Patent Office to issue him a patent.** It only requires that the Patent Office "re-examine" Newman's patent application again.

Newman's counsel, John Flannery said, "It's the kind of political posturing you expect of any politician who's afraid to take a stand. We much prefer those who outright tell us they disagree. The Senator waited until the last two weeks of this Session of Congress to introduce the bill; it won't be considered, at the earliest, until January of 1987. In the meantime, Senator Cochran is, by this bill, actively discouraging any other Senator from introducing a patent bill and insisting instead on legislation that grants Joe [Newman] nothing but another gauntlet to run with no prospect for a patent at the end of the line. This ain't my idea of good government. It is little wonder that the way we found out about it was from the press, not from the Senator's office."

In essence, Joseph Newman is **totally** opposed to S. 2832 which represents an apparent attempt by Cochran to confuse the issue and cost the taxpayer more money. A bill calling for a Congressional patent (identical to the 11 House bills) is straightforward and does not cost anything. Cochran is attempting to "straddle the fence" with S. 2832 — a bill that has been referred to a Senate Judiciary Subcommittee and will probably die in Committee after months of inaction.

In other words, through such sandbagging tactics, Cochran has wasted everyone's time with this bill. If the effort is made to pass a bill, then such an effort should be focused on a Bill granting a Congressional patent. The Patent Office has proven itself to be biased and incompetent — and yet Cochran wants to have this same bureaucracy "re-examine the patent"! We urge all Mississippians to contact Thad Cochran and demand that he demonstrate a **sincere** concern by immediately introducing a Senate bill identical to the 11 House bills to grant Joseph Newman a Congressional patent. Unlike Cochran's bill, these 11 bills do not cost the taxpayer anything.

Nine of the 11 House members who have introduced these 11 bills are from states *other than* Mississippi. It is ironic that these nine Congressmen better represent the interests of the people of Mississippi than does Thad Cochran. As one of the 11 bill sponsors, Congressman Wayne Dowdy of Mississippi, states, "no one should have to endure the treatment Mr. Newman has undergone at the hands of the United States Patent and Trademark Office." And he adds that "instead of promoting Mr. Newman's invention, the Patent Office has spent thousands of taxpayer dollars to thwart him. **If the Patent Office denies this country the benefits of what could be a revolutionary energy device, then its obstinacy would, in my mind, be criminal.**"

And yet Thad Cochran would have the Patent Office "re-examine" Newman's patent application at more expense to the taxpayer.

For further information contact:

Joseph Newman, Route 1, Box 52, Lucedale, MS 39452 (601) 947-7147

XVIII. CYCLOTRON DISCUSSION

Dr. Leon Lederman, Director of the Fermi Laboratory in Batavia, Illinois, stated on the NIGHTWATCH program that he is asking our government to supply over \$4 billion to construct a massive cyclotron having a 52-mile circumference. This device is intended to enable us "to understand the fundamental unit of all matter," according to Dr. Lederman. Joseph Newman teaches that the fundamental unit of all matter is a unit possessing a spin having precise gyroscopic characteristics. Knowing that such a unit— which is the essence of all magnetic fields — behaves exactly as a gyroscope, provides the mechanical key that enables us to unlock the power of this unit for the benefit of humanity.

Due to the unjust influence of a memorizing teaching system which they were forced to endure, Dr. Lederman and his colleagues at the Fermi Laboratory and elsewhere ignore the fact that this fundamental gyroscopic unit comprises the tremendous electromagnetic fields that are used to trap and accelerate larger particles within the cyclotron. Classical physics teaches that the magnetic lines of force are essentially "imaginary constructs" composed of "potential energy." Joseph Newman teaches that the magnetic lines of force are **real** and consist of kinetic energy that can be harnessed to produce work.

It is absurd to assume that the accelerated particles in a cyclotron are essentially unaffected by the gyroscopic entities comprising the cyclotron's magnetic field. The gyroscopic entities both spin at the speed of light and move at the speed of light. Joseph Newman maintains that the larger the cyclotron and the faster the accelerating particles approach the speed of light, then the faster will greater number of gyroscopic entities combine at right angles to the accelerated particle and thereby gyrate around one another in varying numbers to produce ever-increasing numbers of "new and fundamental" particles to further confuse the scientists!

What the unjustly-influenced scientists overlook is that the fundamental unit **is** the gyroscopic entity. In their forced ignorance the scientists are using this gyroscopic entity to create larger particles in quest of the "elusive" fundamental unit that exists in the very composition of the magnetic fields employed in the cyclotron and whose effect they continue to ignore!

The proper purpose of a cyclotron is to be used as a tool to understand the basic construction of matter. Joseph Newman understands matter in a way that has never before been **mechanically** understood. However, such understanding is still not the ultimate level — there is always room for new learning. Yet our own government continues to fight what Joseph Newman strives to accomplish for humanity.

The \$4 billion cyclotron that is now being contemplated *should* be built, and the reason is that it will provide a better understanding of matter. But this under-

standing will not be achieved by the implicit approach now being taken by the scientific community — not by taking particles, accelerating them, and then smashing them together. This is similar to taking two vehicles, smashing them together at lightspeed and then observing the shattered wreckage in an attempt to comprehend the original construction of the vehicles.

It is far better if one analyzes each of those component parts independently, form them, see them being formed, and use this knowledge to obtain a **precise mechanical understanding** of the two vehicles' original construction. The same is true of matter.

What cyclotron scientists should do is to accelerate particles and greater numbers of particles in the tremendous magnetic fields that they utilize. The basic building block of all matter is the energy in a magnetic field. As one accelerates particles closer to the speed of light, one then causes such particles to interact with the gyroscopic particles comprising a magnetic field and causes these particles to spin in specific, gyroscopically-induced directions. As this happens, more gyroscopic particles in the cyclotron's magnetic fields join the mechanical interactions to spin and form matter. It is the *mechanical* understanding I have stressed in this book that is tremendously important in the understanding of matter.

This is what should be done with the cyclotron that will be built: One can still perform the tests currently performed by the scientific community, but I am certain that there will be far more learned by *forming matter* as the particles one accelerates (and as one accelerates more of these particles) react with the trillions of particles in an intense magnetic field. When one has only a single particle, then there is less of an opportunity for such reaction: if one has more particles, then one has a greater opportunity to cause more particles to interact in the magnetic field and to gyrate around one another to mechanically form more and larger particles of matter. As one consistently observes these results, I am certain that it is going to provide science and humanity with a greater understanding of **how to mechanically build any type of matter**.

I can envision that the day will come when one takes electromagnetic energy, places it in a device, and then will be able to generate *any* form of matter that one desires. This transformation is presently accomplished in reverse by the sun. Every element that exists on the sun is converted into electromagnetic energy and radiated to the Earth. Many of the hydrocarbons, amino acids, etc., which are found on Earth have developed from this original solar reaction.

One can take electromagnetic energy, convert it into matter and from matter convert it back into electromagnetic energy. The day will come when young men and women who have been taught to use their minds will perceive a way to assemble pure electromagnetic energy

and any material desired — lead, gold, iron, any element, any compound — by simply “pushing the correct button” to cause the proper mechanical reaction, the material will be electromagnetically assembled. As the reader may conclude, this is of tremendous importance to the advancement of humanity.

The scientific community should open their minds, look at the truth of what I teach, and not be so attached to the biases and prejudices that are the result of years of memorized instruction.

With a proper and explicit mechanical understanding of nature, we will literally have the Universe at our fingertips.

EDITOR'S NOTE: Joseph Newman has hypothesized that it may indeed be possible to exceed lightspeed. As an accelerating entity approaches the speed of light, it proceeds to “accrete” gyroscopic particles. This occurs because the accelerating entity mechanically combines with gyroscopic particles as it approaches their pre-existing, lightspeed motion. The Universe is literally an “ocean” of gyroscopic particles. To surmount this mechanical barrier (analogous to the sound barrier), one must provide the accelerating entity with an electromagnetic shield that mechanically deflects the gyroscopic particles’ attempts to accrete to the accelerating entity. As the accelerating entity then proceeds to pass through this “light barrier,” conceivably there would be no upper limit to one’s speed.

XIX. SUPERCONDUCTIVITY (see pages 53, 289-291)
AND RECOGNITION OF ACHIEVEMENT

Researchers at the University of Houston, Alabama, and elsewhere have recently restated the fact that certain supercooled alloys lower electrical resistance and produce superconductivity of electricity. Joseph Newman has been teaching this process for over 20 years and has consistently maintained that the larger the number of atoms aligned in a coil, then the greater the release of “electromagnetic-atomic” (or **electromagnatomic**) energy from the coil. A supercooled coil reduces resistance and increases atom alignment when voltage (hydraulic pressure) is applied to the coil of material atoms. They have stated that this process represents perpetual motion! Joseph Newman states not so, because if one single gyroscopic particle is removed from its associated magnetic field, then the mass of the conductor is reduced in accordance with Einstein’s equation of $E = MC^2$. What is new, is that they have apparently achieved superconductivity at still very cold, but warmer than previously-achieved temperatures.

In a national science magazine, atomic physicist Bogdon Maglich claims to have discovered a way to produce nonradioactive nuclear energy. With this process, Bogdon Maglich says that “more energy would be produced than was initially consumed. That is, the energy required to get the atoms to release their potential energy was less efficient than the amount of energy the atoms produced.”

Joseph Newman has been teaching this process for over 20 years!

It appears that members of the conventional scientific establishment are finally beginning to recognize the validity of what Joseph Newman has developed over a 20-year period. From the evidence that Joseph Newman presents in this fundamental book and the extensive evidence contained within his files and diaries, it is hoped that there will be recognition of the fact that he pioneered the development of these concepts over 20 years ago. If there is basic justice, then credit should be given where due. Proper credit would further stimulate not only Joseph Newman, but all future inventors for the benefit of the human race.

Example: Quoting from *Science News*, March 28, 1987, entitled “Superconductivity — Physics Rush:”

“High Temperature superconductivity is the physicist’s dream that now seems to be coming true in a tremendous rush. The discovery of substances that lose all electrical resistance at manageable temperatures has been a goal of researchers for 75 years.”

And, quoting from *Science News*, January 10, 1987, page 23 entitled “New Heights in Superconductivity:”

“Researchers have lots of room to search for ways of further increasing the superconducting transition temperature. ‘You can change the composition; you can change the elements; you can apply pressure,’ says Chu. ‘With all this flexibility, I don’t see a limit in the near future.’”

The reader should recognize the fact that I first published this book in 1984. In great detail this book explains and predicts the results described by Dr. Chu in the above quote. [See Chapter 10 through Chapter 15 (pages 71 through 90) in this book.]

Throughout this material, I have diligently and consistently taught that changing the material and the pressure or force applied to the material will cause major differences in the results of the electromagnetic energy release from matter in accordance with $E = MC^2$.

As further proof of this fact refer to paragraph 4 on page 290 of this book concerning superconducting materials: “But how is this done? **Simple — by varying mechanical means of causing atom alignment: applying or not applying pressure, force, or heat, or electrical or magnetic input**, or by decreasing or increasing normal atom random motion or atom alignment. By varying or reversing those mechanical steps, the magnetic field coming from a mass will exist or not exist or reverse direction.”

Refer to Section 25-T on page 79 of this book, especially: “Many such materials will be used in energy machines designed for 100% (conversion) efficient

utilization of Einstein's equation of $E = MC^2$. Such an understanding will also permit the creation of new materials with varying electromagnetic characteristics."

Refer to the last paragraph of Section 27-I on page 84 of this book, "To create such a system will require standard testing as demonstrated in the 19th Century by Thomas Edison's perfection of the design for the light bulb."

What is now happening worldwide concerning the tabletop breakthrough on the advancement of Superconductivity is exactly what I predicted would occur by changing materials, heat, electrical and pressures relative to those materials!

To further emphasize the correctness of my teachings, I advise those individuals working in the advancement of Superconductivity not to only heat materials and then apply pressure, but apply heat and/or electricity for a given time and apply pressure while the material is still in the heat and/or electrical environment and then raise the heat environment for a further given time and then apply additional increases in pressure. By conducting many different tests, one will find, as I teach, that small changes in one or more parts of the procedure will cause drastic changes in the ability of the finished material to allow the gyroscopic particles comprising its atoms to come outside the boundaries of the material which we call a (magnetic) electromagnetic field and result in Superconductivity even at room temperature.

The Scientific method is simple: Let the "Facts" prove or disprove the "theory" and the "Facts" of the mechanical methods of the tabletop breakthroughs of warmer and warmer Superconductivity prove the correctness of my Pioneering Invention and Technology. Why? **Because the phenomena of Superconductivity at warmer and warmer temperatures matches exactly what I have so diligently taught: "That the most efficient design of the Invention is one in which the smallest amount of current input causes the greatest amount of atom alignment of the material." And that is exactly what a Superconductor does!**

EDITOR'S NOTE: In a discussion in Atlanta, Georgia on April 7, 1987, with Dr. Roger Hastings, Joseph Newman, and in accordance with the teachings of Joseph Newman, I recommended — for the purpose of explicitness — that superconductivity researchers consider applying very high voltage/low current to superconducting materials as high pressure is also applied. This procedure — as originally developed and described by Joseph Newman in his Pioneering Patent application and this book — could possibly cause the gyroscopic particles comprising the high voltage (hydraulic pressure) to mechanically "carve out" the most accessible atomic-alignment-paths in the superconducting materials at the precise moment when the atoms of the material are being compressed via high pressure. Experimenters could also test various combinations of high voltage and high pressure to obtain maximum atom alignment for the materials involved as taught by Joseph Newman. As Dr. Hastings pointed out, such high voltage and pressure should also generate heat in the superconducting materials.]

XX. ADDITIONAL WEATHER DISCUSSION

(see pages 144-153, 284-288)

To further demonstrate the connection between electromagnetism and weather effects, Joseph Newman designed a simple test which he displayed in conjunction with his electric car demonstration at Biloxi, Mississippi on March 11, 1987.

A serrated, copper disc with sharp edges was suspended in a level fashion above an aquarium tank filled with water — preferably distilled water. (See Figure A.) One lead from a transformer was attached to the copper disc and a second lead was immersed in the water at the rear of the tank. A mirror was inserted in the tank of water at a 45° angle which permitted the viewer to observe the underside of the disc and the water's surface as seen from below. Utilizing the power from an A/C electrical outlet, a transformer was used to input approximately 12,000 volts into the serrated copper disc suspended above the water. The distance between the disc and the surface of the water is very critical to observing lightning effects.

When the volts are applied, one can quickly see an aurora effect around the copper disc. (See Figure B.) The

energy emanating from the tips of the disc show electromagnetic effects similar to what one sees during electrical storms, tornadoes, and hurricanes. Bursts of lightning will also occur beneath the copper disc as the charge differential continues to build up between the disc and the water.

In addition, the motion of the water created by the electromagnetic discharge is similar to what occurs when storms pass over bodies of water. The particles on the water's surface move in spin directions as indicated in Figure C. When the input voltage is eliminated, the motion of the particles rapidly cease.

The importance of this simple demonstration is that *all* storm phenomena are the result of electromagnetic activity that can be understood and predicted. Such knowledge will enable humanity to control the weather, dramatically improve the development of agriculture, and increase the safety of life on Earth. The reader is urged to master the technology in this book and recognize that electromagnetism is the *basic source* of natural phenomena.

WEATHER EXPERIMENT (Figures A, B, C)

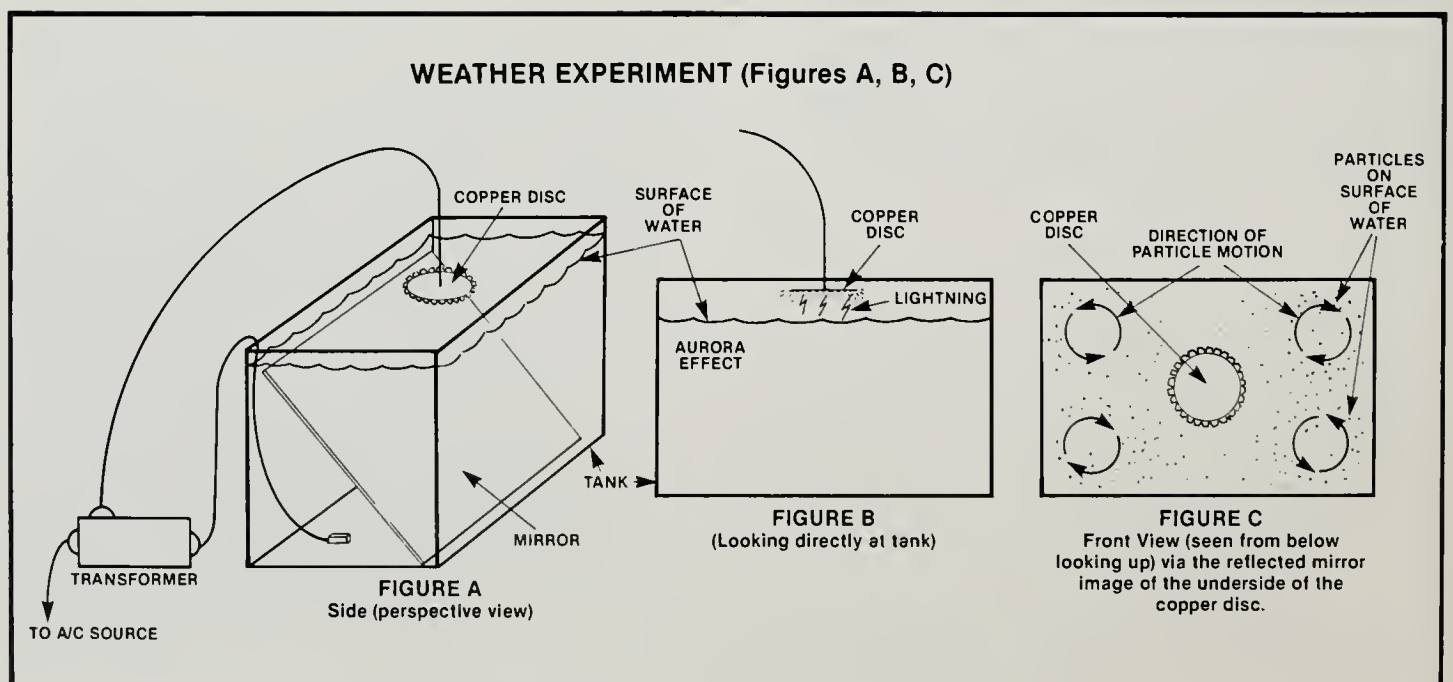

XXI. Events occurring between FALL 1986 and SPRING 1987 concerning the effort to secure a pioneer patent for Joseph Newman's energy machine.

TECHNICAL DEVELOPMENTS: On Wednesday, March 11, 1987 Joseph Newman successfully demonstrated his revolutionary electric car at the Biloxi, Mississippi Coliseum before 750 people and newsmedia. At the demonstration, the 550-lb energy machine motor powered a STERLING-body car (mounted on a Porsche chassis) for two hours using a current equivalent to that supplied by a **1 ½-volt transistor battery!**

As evidenced by the facts concerning electromagnetism, the current equivalent to what is in a small 1 ½-volt transistor battery should not even move the automobile, much less run it. For it to do so, proves that the magnetic field supplying the energy must come from the basic composition of more than 200 lbs of atoms in the motor's copper coil and the 200 lbs of atoms in the motor's permanent magnet. The energy released by the motor is released in accordance with the matter-to-energy conversion process described by Einstein's equation of $E = MC^2$ and occurs without pollution to the environment or the human race.

Conventional teachings in present physics books state that this cannot be done. Joseph Newman has numerous 1 ½-volt transistor batteries connected in series which provide high voltage/very low amperage and produce power to move the 1800-lb automobile at low speed. The automobile at the Biloxi, Coliseum ran at walking speed.

Joseph Newman asks the question: what is the ultimate power source that powers his electric car? He maintains that it is *not* the small amount of current from the 1 ½-volt transistor batteries hooked in series, but rather it is caused by the energy released from the interaction of the magnetic fields generated by the motor's copper coil and permanent magnet. The magnetic field generated by the copper coil is caused by the coil's atom alignment which results from **high voltage/low amperage** input.

CONVENTIONAL SCIENCE TEACHES: to have an efficient motor one must use large current input and low voltage.

JOSEPH NEWMAN TEACHES: just the opposite! High voltage with low amperage (as low as possible) will generate strong magnetic fields in the coil and thereby induce the release of magnetic to electric energy through an *electromagnetic* (rather than fission) *reaction* in accordance with $E = MC^2$.

It is important to stress that Joseph Newman connects the 1 ½-volt transistor batteries in **series** — not in parallel. A series connection is made by hooking a wire from the positive terminal of one cell to the negative terminal of the next cell in a chain fashion, until all the cells are connected. The total current-carrying capacity is therefore the same as that of a *single cell*.

The 1800-lb car already had run for eight hours prior to the March 11, 1987 demonstration that was featured on National CBS Evening News. After two hours the newsmedia and people were ready to leave, having seen

demonstrated what conventional science says is not possible. The statistics on the demonstration were — **VOLTS IN:** 15,640; **AMPS IN:** 10-25 milliamps (a conventional electric motor starts with a surge of approximately 500 *amps* and runs on 100-200 *amps*); **VOLTS OUT:** over 100,000; **AMPS OUT:** (2 components) — the AC was twice the DC input and the R.F. (radio frequency) was ten times the DC input.

In December, 1986 the car motor was damaged in shipment from Lucedale to Jackson, Mississippi although it was successfully demonstrated in Lucedale prior to shipping. The PVC tubing associated with the motor's coil slipped and compressed the PVC tubing which acted as a brake on the shaft. The shaft itself is still out of alignment by 10,000th's of an inch. Later the PVC tubing, coil, and braking problem were repaired, but the shaft remains bent. To repair the shaft would require complete motor rebuilding. Presently, Joseph Newman is seeking the funds to rebuild the motor. (Most of Joseph Newman's assets are now being spent to fight the Patent Office which is financed by *your* tax dollars!) Dr. Roger Hastings calculated that frictional losses due to the bent shaft *alone* exceed the power input! Yet the 1800-lb car still moves and proves that Joseph Newman's teachings are correct as did the first, 12-second, 120-foot flight of the Wright Brothers in 1903. In fact, the Wright Brothers' first four flights lasted between 12 and 59 seconds and each went only a short distance. But these flights proved for the first time that powered flight in a heavier-than-air flying machine was possible. The flying machine had, however, a very difficult time securing a patent and in 1903 the Patent Office informed the Wright Brothers that their claim to a flying machine was rejected because it related to "a device that is inoperative or incapable of performing its intended function." The Wright Brothers had to battle the Patent Office for 3 ½ years before securing a patent.

Joseph Newman has continued to battle the Patent Office for over 8 years although he has or is receiving energy machine patents in Spain, South Africa, India, and Argentina.

LEGAL DEVELOPMENTS: During the week of December 8-12, 1986, Federal Judge Thomas P. Jackson conducted the trial of Joseph Newman vs the Patent Office in Washington, D.C. The trial went quite well for Joseph Newman. Physicist and magnetic expert Dr. Roger Hastings, electrical specialist/battery expert Ralph Hartwell, and mechanical engineer Milton Everett testified on behalf of Joseph Newman during the trial's first three days. The Patent Office was unable to refute **any** of the technical testimony of these three experts. After the trial, written post-trial briefs were submitted by both sides on March 2, 1987. Verbal closing arguments still remain (as of this writing) after which Judge Jackson can *take as long as he wishes* to issue his decision. In an unrelated case, a trial ended 2 ½ years ago and Judge Jackson still has yet to issue a decision! Speedy trials (and decisions) seem to come at a premium in Jackson's

Court. Joseph Newman is still interested in trying to find a way to directly sue Patent Office officials via a trial-by-jury. Suggestions are welcome.

ONE DIRECT BENEFIT OF THE TRIAL: *three days of expert testimony for Joseph Newman represent the finest technical testimony yet assembled on Joseph Newman's technology!* (We hope to make available the complete, 600-page trial transcript and excellent post-trial brief.)

During a cross-examination, the Patent Office's thermodynamic expert belatedly conceded that if the energy machine worked as Joseph Newman claimed then **it did not violate the First or Second Laws of Thermodynamics and therefore was not "impossible."**

During extensive technical testimony, Dr. Hastings explained how the energy machine obtained more energy output than external energy input: "When current flows through the motor, there is a torque exerted in the rotor and then, in return, the rotor induces a back current or an opposing current in the coil." Dr. Hastings concluded, "When the reaction of the rotor on the coil is smaller than the force that drives the rotor," then there is "more output power than input power."

In lieu of Judge Jackson's actions to date, we are not expecting any "miracles." And either side could still appeal the decision. At the very beginning of Joseph Newman's contact with Judge Jackson *over three years ago*, Jackson stated that he needed a Special Master (court expert) to *expedite* proceedings and **SAVE JOSEPH NEWMAN MONEY**. (See pages 274-277, 306.)

QUESTION: Do Judge Jackson's actions belie his words? Now, over three years later, the Patent Office filed papers on March 2, 1987 seeking to have Jackson order Joseph Newman to pay the Patent Office \$102,181.95! \$98,649.26 of this amount is to pay for the National Bureau of Standards' tests conducted last summer (see pages 317-321) and since *discredited at the December 1986 trial!* Moreover, this does not include the more than \$700,000 in expenses relating to the legal battle conducted by Joseph Newman over the past three years. Yet the clock drags on, the expenses mount up, and the political/judicial injustice continues to deny the people an invention that will revolutionize our lifestyle and provide us with abundant, inexpensive and non-polluting energy to power our homes, cars, factories, farms and appliances.

POLITICAL DEVELOPMENTS: In 1986, eleven Congressmen introduced eleven identical Private Bills to grant Joseph Newman a Congressional patent. These Bills do not make a scientific judgment about the energy machine, but leave it up to the American marketplace. [In the House, Private Bills cannot be co-sponsored and must be separately introduced; in the Senate, private Bills *can* be co-sponsored.] All eleven Bills were **KILLED** by Congressman Robert Kastenmeier of Wisconsin who refused to simply schedule an open hearing in his Subcommittee. *His excuse:* "the issue is in litigation and doesn't belong in Congress." *Reply:* Many Bills are both

introduced and passed in Congress while litigation is pending in the Courts; moreover, why should the American people be judicial hostages during years of litigation since Congress constitutionally has the power to issue patents? Also, Kastenmeier's attitude actually punishes Joseph Newman **for his own litigation!** It was not the Patent Office that initiated the suit, but Joseph Newman who filed the suit in an effort to seek justice and keep his "patent pending" status valid with such legal action. Is it fair to penalize Joseph Newman's pursuit of the only legal recourse available to him by refusing to schedule hearings on this issue in Congress?

Robert Kastenmeier also says that the President's "official representatives" oppose the Joseph Newman Bills. Who are these unnamed "official representatives?" What is the specific evidence of the President's opposition? We have a right to know all details. And since when is a Democratic Congressman (Kastenmeier) so concerned about what a Republican President (Reagan) thinks of pending legislation? Something is definitely wrong here. **IMPORTANT CONGRESSIONAL DEVELOPMENT:** As a member of the House Appropriations Committee, Congressman Robert Livingston will attempt to attach an amendment to the Bill authorizing Patent Office funding. The amendment would deny *only* that funding used by the Patent Office to fight Joseph Newman's effort to obtain a patent.

To "scientifically summarize" the political opposition to Joseph Newman's energy machine:

"If a pound of mass were completely converted into energy, about 10 billion kilowatt hours would be obtained. If one mass unit (*i.e.*, one proton) were converted into energy, 931 million electron volts would be obtained. It has been estimated that one gram of matter, if totally consumed, would run a home for a thousand years.

Our problem is *not* an energy shortage, but rather a bureaucratic overage!"

OTHER ENERGY MACHINE NEWS: There has been extensive coverage of Joseph Newman's work in Sweden. Tom Leone of Lansing, Michigan suggested that people **contact their local public and high school libraries** and request that this book be ordered to enable more people to learn about this new technology. We also thank Mr. Leone for holding a demonstration in support of Joseph Newman on the steps of the Michigan Capitol during the Biloxi, Mississippi demonstration. Supporter Sandy Smith writes: "I took your book to Tulsa University and my sons' electrical engineering graduate course ... the boys stayed up all night reading; their conclusion: it's a marvelously exciting discovery ... their comment, 'It brought all four years' studies together and made them make sense; he should write textbooks.'"

The ORANGE COUNTY REGISTER (9/3/86) carried four powerful letters-to-the-Editor in a section entitled "Impeach the Judge Who Stopped the 'Energy Machine.'"

V.A. Bickov of Bloomington, California wrote, "Judge Jackson, at the very least, is guilty of malfeasance in office in keeping such a machine from the American people and industry, a machine that seemingly permits our country to cease being dependent on oil imports and maybe even atomic energy."

In the 10/23/86 WALL STREET JOURNAL, Congressman Robert Livingston wrote in a letter:

"I am convinced that the Patent Office has not followed normal or proper procedure in the handling of Mr. Newman's application. As a result, taxpayer money is being used improperly. This situation is doubly alarming due to the fact that the invention just might be beneficial to hundreds of millions of people ... From a legal standpoint, this case is an abomination. But in the final analysis, it should be the marketplace, and not the government, that determines the worth of Mr. Newman's invention."

David E. Cowlshaw in Silverton, Oregon writes: "If you would like to see this invention survive the cover-up, then do something! Communicate, explore, and never take 'impossible' for an answer!"

John Eckert of Oneonta, New York writes: "Through the efforts of dedicated people like yourself, the dignity of the individual will be enhanced ...". And Don Kelly of Clearwater, Florida puts it very succinctly when he writes: "We now have a situation in the United States where **second-rate bureaucrats** are making judgment calls on the work of **first-rate engineers and scientists**, and if this situation is allowed to continue we had best call off the 21st Century, due to lack of interest!"

We especially wish to thank everyone for their continuing efforts on behalf of Joseph Newman and for the kind letters we receive from across the United States and Europe. We will *not* give up and we are grateful for your continuing assistance in this battle where the durable future of humanity depends upon this revolutionary technology being developed to benefit your children and your descendants. As Dr. Hastings said, "***If you have any conscience at all, you can't walk away from this.***"

XXII. The following contains information relating to individuals who are attempting to interfere with the expansion of this technology and features a chronology of events.

Joseph Newman Publishing Company

Route 1, Box 52, Lucedale, Mississippi 39452

(601) 947-7147

FOR IMMEDIATE RELEASE

To The People Of The United States And The World And In Remembrance Of The Essence Of The United States Constitution And Its Upcoming Bicentennial

★ ☆ ★ ☆ ★ ☆ ★ ☆ ★ ☆ ★ ☆ ★ ☆ ★ ☆ ★ ☆ ★ ☆ ★ ☆ ★ ☆ ★ ☆ ★ ☆ ★

As I have stated in my book, THE ENERGY MACHINE OF JOSEPH NEWMAN, "I view you, the People, as a Majestic Sleeping Lion and I wish to awaken you!"

The employees of the United States Government — in their eagerness to serve injustice to you, the People — may be just the needed noise that awakens you.

The subject of this Press Release and the object of attack by the United States Government concerns the technology I teach which will end all pollution on Earth, will permanently end the energy problem, will totally prevent any future Ethiopias, will generate many beneficial changes in our economic system, will cause the work-hour week to approach one hour per week, will enable space travel to become a reality within 20 years, and no aspect of science will remain untouched by this revolutionary technology to benefit humanity.

For the last three years I have consistently stated that when the News Media dug into the facts concerning the gross injustice relative to the Newman Energy Invention Patent and Court Case, **that the Facts unearthed would make Watergate appear as a mole hill to a mountain.**

Let's look at the Facts:

- (1) If the Energy Invention came forward quickly, many financial people associated with conventional energy — people who have clout and political power — would possibly become insignificant.
- (2) On March 21, 1984, I received a "standard-type reply" from the Special Assistant to President Reagan, who returned all of the materials I had sent, materials that were neatly packed as though they had not been opened. Included was the closing statement, "So many similar requests are received that it just is not possible to comply."
- (3) As I unpacked the material I had sent in (2) above, I discovered a foul-up on the part of the White House: I found accidentally enclosed with my materials, a White House Video Review of a tape I had sent and from which conclusions were totally opposite to (2) above and proved (2) above to be a blatant falsehood. The White House Video Review stated, and I quote: "Summary: A new energy source — Electro-magnetic device — John Stennis requested funding — Needs help to get U.S. Patent, some scientists believe this invention could change the world as it converts mass into energy — runs on its own energy, WWL TV-Channel 4, New Orleans, gives it excellent coverage."

A section of the Review marked "Special cases to Chuck Donovan, Room 94," was checked (✓) — meaning that the materials and the Video Review was a special case and was therefore sent to him.

You and I both know that President Reagan receives very little, if any, material from outside sources that gets such an extreme, impressive review and that could be of such vital importance to the "People" of this nation and the world.

- (4) President Reagan appointed Donald Quigg Commissioner of the U.S. Patent Office.
- (4a) Donald Quigg was a top executive with PHILLIPS PETROLEUM for more than thirty years before being appointed to head the U.S. Patent Office.
- (4b) Donald Quigg has consistently published verbal and written falsehoods concerning my Revolutionary Energy Invention. Example: Quigg, as well as the Patent Office, states that I have a "Perpetual Motion Device."
- (4c) The Federal District Court in Washington, D.C. appointed Special Master William E. Schuyler, Jr. (a former Patent Office Commissioner with "superb credentials" according to Judge Thomas P. Jackson) who stated in his Special Master's Report that "Newman has specifically disclaimed that his invention is a Perpetual Motion Machine."
- (4d) Even more incriminating: Reagan's own staff member who viewed by work stated the Truth [see (3) above], "as it converts mass into energy — runs on its own energy."

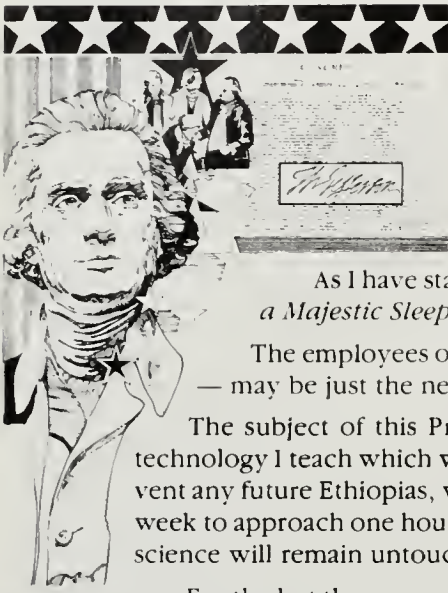

- (4e) Further incriminating evidence: at the recent trial on my Pioneering Patent Application, even the Patent Office's own expert admitted, if the energy machine worked as Joseph Newman claimed, then it did **not** violate the First or Second Laws of Thermodynamics and therefore was **not** "impossible."
- (4f) And still further incriminating evidence: the Special Master stated in his Report — "Defendant (The Patent and Trademark Office) intentionally did not consider the formalities of the Plaintiff's (Joseph Newman's) application or the patentability of Plaintiff's claims under 35 USC, Sec 102/103." (This means that the Patent Office intentionally did not follow the law.)
- (4g) Question: Why the deliberate falsehoods to the "People" and the "News Media" by Quigg and the Patent Office?



Thomas Jackson, now a judge, is pictured above (right) when he was an attorney for John N. Mitchell (left) during the Watergate scandal.

- (5) After experiencing years of injustice from the U.S. Patent Office, I went to the U.S. Federal Court in Washington, D.C. in hopes of receiving justice at which point Judge Thomas Penfield Jackson was given my case. Let's look at additional facts:
 - (5a) President Reagan appointed Thomas Jackson as a Federal Judge in 1982.
 - (5b) It has been reported that Thomas Penfield Jackson was the attorney for John N. Mitchell during the Watergate scandal and was also the attorney for the notoriously corrupt finance division of the committee to re-elect the President, which was named CREEP (see copy of the picture of Jackson with Mitchell). One of Jackson's law partners of that time, Kenneth Parkinson, was one of the seven indicted for the cover-up conspiracy in the Watergate scandal. However, he was the only one acquitted.
- (5c) Nixon was replaced by President Ford, then President Carter, and then very soon after Reagan was elected as President, Reagan nominated Thomas Penfield Jackson for Federal Judge. (During the Watergate Scandal, Thomas Penfield Jackson was a person who had already proven to People in Financial and Political Power that he could be trusted as a Federal Judge to represent their interests.)
- (6) Thomas Penfield Jackson conveniently became the Federal Judge handling my case.
- (6a) Jackson stated that he had no technical ability and needed a Special Master (someone who was skilled in the art to evaluate my energy machine.)
- (6b) I objected to his need for a Special Master and stated that the Court needed only to count true witnesses of operability of the Invention of which I had thirty competent scientific-minded individuals and the Patent Office had zilch.
- (6c) **Jackson stated in the Court record that the reason he was using a Special Master was to expedite the Summary Judgment and to save me money.**
- (6d) Thomas Penfield Jackson then chose a Special Master — William E. Schuyler, Jr. — **nominated by the U.S. Patent Office**, and Jackson specifically stated the fact that the Master's "credentials were superb." Mr. William E. Schuyler, Jr., was a former U.S. Commissioner of the Patent Office, with a background in electrical engineering and years of patent law experience.
- (6e) Within a short period of time on September 28, 1984, the Master issued his Report which stated: "Evidence before the Patent and Trademark Office and the Court is overwhelming that Newman has built and tested a prototype of his invention in which the output energy exceeds the external input energy; there is no contradictory factual evidence." [This statement proved that what I had stated in (6b) above was true.]
- (6f) The U.S. Patent Office had already stated in writing that if my Invention worked then I would be entitled to a "Pioneering Patent."
- (6g) The Supreme Court has already ruled that a Pioneering Patent was something that had not been done before.
- (6h) Thomas Penfield Jackson had open to him a perfectly clear road to rule that the Pioneering Patent should issue, since the Special Master was nominated by the Patent Office, the Patent Office had stated that I would be entitled to a

Pioneering Patent if the Invention worked, and the Special Master had stated the evidence was “overwhelming” the Invention worked.

- (6i) Thomas Penfield Jackson charged me \$11,602.20 for the Special Master’s Report that he originally stated he must have and then Jackson threw out his own Special Master’s findings! This was a shocking violation of Federal Law which states that: if a Special Master is hired in the absence of a jury then the Special Master’s findings must be accepted unless clearly erroneous.
- (6j) When Thomas Penfield Jackson was asked by my attorney to provide evidence that the Special Master was wrong, Jackson stated: “I am not going to tell you.” Moreover, **he has not told us to this day!** Question: Why should a Federal Judge deliberately violate Federal Law and risk attention to be drawn to himself, when he could have followed the Law and been perfectly safe?
- (7) It became extremely obvious to me that my ordeal was now not only a patent ordeal but also a judiciary ordeal. Prior to this time I had as many as three attorneys at once working together in my defense. However, because of deliberate injustice by the Patent Office and the Federal Court, I was forced to replace these attorneys with an extremely competent litigator, Mr. John Flannery of the Washington, D.C. area.
- (7a) The first time Mr. Flannery and I went before Thomas Penfield Jackson, I bet Mr. Flannery twenty (20) to one (1) odds that he would find Jackson to be **deliberately unlawful** and **not** a representative of Justice.
- (7b) Mr. Flannery, a person who has great respect for justice as do I, took the side of Jackson and said that he felt the Judge was simply overwhelmed by the magnitude of what I had accomplished.
- (7c) Within a few minutes of having to deal with Judge Thomas Penfield Jackson, Mr. Flannery knew I was correct and Mr. Flannery nevertheless handled himself most impressively under the extreme unjust conditions and actions of Jackson, so much so, that Mr. Flannery paid me our wager before we left the courthouse, and said that I was most definitely correct in my original assessment of Judge Jackson.
- (7d) Even though I had numerous attorneys — some from California, Alabama, Washington, Mississippi and Louisiana — tell me not to file a Writ of Mandamus against a Judge, because Judges protect each other with more diligence than attorneys do attorneys, or doctors do doctors, I did so, because I despise injustice, and what they were describing to me was a procedure of endorsement of injustice. Mr. Flannery, because he has guts and believes in justice, filed the Writ of Mandamus in my behalf against Thomas Penfield Jackson for throwing out the Special Master’s findings without providing evidence to the contrary. [A Writ of Mandamus states that a Federal Judge is guilty of the criminal act of violating the law.]
- (7e) The Federal Circuit turned down the Writ of Mandamus on May 29, 1985, being signed by Oscar H. Davis and co-authored by Rich and Baldwin. My position is now as it was then, that by their failure to uphold my Writ of Mandamus against Jackson, these three Judges had endorsed the violation of a Federal Law and a Mockery of Justice by Judge Thomas P. Jackson!
- (7f) Look back at (6c), where Jackson states he hired a Special Master to expedite the Summary Judgment and to save me money, then refer to (6e) above, where the Master says the Invention works, then refer to (6i), where Jackson violates Federal Law and throws out the Master’s Findings and then refer to (7e), where more than eight months later than in (6c) a terrible injustice is endorsed by Jackson’s colleagues. And this occurred even though the facts prove that Thomas Penfield Jackson told a blatant Falsehood! And even though Jackson blatantly violated Federal Law!
- (7g) After refusing to accept his own Special Master’s findings of fact, Thomas Penfield Jackson then compounded injustice on top of injustice by ordering me to turn over a prototype of my invention to an entity that Jackson knew from the Court Record was biased and prejudiced against this invention, since employees of this entity had previously submitted an affidavit saying that my invention was impossible: The National Bureau of Standards (NBS).
- (7h) Thomas Penfield Jackson then multiplied the injustice further by ordering the Invention Prototype to be turned over to the NBS so that they could keep it until the trial was over or destroy it as they wished, that my colleagues and I would not be present for testing, nor would we be informed of the test to be conducted.
- (7i) It was obvious to me that Jackson was determined to conjure up false evidence to justify his unlawful act of having originally turned down his own Special Master’s findings of fact that said my invention worked. Upon going outside of the Courthouse following a hearing with Jackson, the News Media asked me if I would do as ordered. My instant comment was, “Not no — **Hell No!**”
- (7j) Jackson attempted to imply that if I did not do as ordered, then I had something to hide. Therefore, to further demonstrate Thomas Penfield Jackson’s judicial injustice and hypocrisy, I used a tractor trailer truck to deliver a 9,000 lb Prototype of the Invention to the Capital Center Auditorium near Washington, D.C. and I held a public demonstration for the News Media with competent scientists speaking out on the validity of my years of work and

the successful operability of my Invention. This demonstration proved that I had nothing to hide and further exposed the Injustice perpetrated by Thomas Penfield Jackson.

(8) Through my attorney, John Flannery, I filed a **second** Writ of Mandamus against Thomas Penfield Jackson for his compounded injustice, in spite of the fact we both had grave doubts from past experience that I would receive Justice from the United States Court of Appeals for the Federal Circuit.

(8a) However, on January 13, 1986, The U.S. Court of Appeals consisting of Judges Markey, Newman, and Bissell upheld in part the Second Writ of Mandamus against Thomas Penfield Jackson. (This means that the Higher Court agreed that Thomas Penfield Jackson was violating Federal Law!)

The following is a quote from the decision issued by the U.S. Court of Appeals: "When petitioner had objected to the 'extraordinary burden' imposed by the test conditions authorized by the District Court, the Court responded that this 'unprecedented' device 'needs precedent[ed] [sic: unprecedented?] procedural adaptations of the Federal Rule.' However, the Federal Rules of Civil Procedure are more than guidelines for orderly litigation; they ensure that the proceedings are conducted fairly, with the objective of uncovering the Truth, and in accordance with fundamental principles of due process." (This means that Thomas Penfield Jackson was not only breaking Federal Law but also violating good conscience.)

(8b) However, this U.S. Court of Appeals restated that it was OK for the blatant violation of Federal Law and Justice described in Sections (6c), (6e), and (6i) above.

Such a conclusion was ridiculous in light of the compounded injustice by Jackson that the Higher Court condemned in (8a) above. When it is obvious that because the Higher Court had already endorsed injustice in the turndown of my first Writ of Mandamus [see (7e) above], Jackson had been encouraged to do the compounded injustice that they had just ruled against in (8a) above.

(8c) This "Truth" is verified by the fact that the date of (8) above (January 13, 1986) was more than **1 ¼ years** past (6c) and (6e) above and at a cost to me for a Spécial Master and legal fees well over \$100,000.00, which makes Jackson's statement of (6c) a blatant falsehood and a mockery of Justice as verified in (6i) and multiplied by the Higher Court's OK and endorsement of that blatant violation of Federal Law and of Justice.

The following facts verify this "Truth" regarding said "Injustice" and prove said "Injustice" is consistently multiplied!

(9) Eleven different Congressmen, the Republican Study Committee of Congress, the New Orleans City Council, the Lucedale City Council, and the Mississippi House and Senate have all sent Bills or Resolutions requesting that Congress issue Joseph Newman a Pioneering Patent, because both the Patent Office and Judiciary System had failed to serve Justice regarding same.

Congressman Wayne Dowdy of Mississippi hit the nail on the head when he stated: "**If the PTO denies this country the benefits of what could be a revolutionary energy device, then its obstinacy would, in my mind, be criminal.**"

In his obstinacy, Judge Jackson has turned down my request to have a trial by jury. Moreover, at one point during this case, the attorney for the Patent Office informed my attorney that "he would hate to have a trial by jury."

(10) Referring again to (8a) above, the Higher Court (Federal Circuit) ordered that "I deliver a prototype to the NBS for testing. That the NBS or PTO could **not** destroy or dismantle the device. That the NBS notify the parties **before** testing began. Both parties shall have the right to **observe all tests**. Attention is directed to the requirement that the **test be completed** and the report issued **within thirty days after delivery of the device.**"

(10a) Still under protest, I sent the device to the NBS in the good faith that those reasonable requests would be followed as ordered by the Higher Court (Federal Circuit).

(10b) The thirty days from delivery of the device passed at the NBS **without any test being conducted**. The NBS did waste time trying to convince the Higher Court that I was possibly a fraud and that the NBS must destroy the device or they would not run tests. The Higher Court turned down the request of the NBS and stated that the original order of the Higher Court remained. Moreover, had the NBS destroyed my invention, then this would have eliminated the possibility of my using that invention in its original condition as evidence during the forthcoming trial.

(10c) During the 30-day period, the NBS did cause me to travel more than 1,000 miles to Maryland when the NBS claimed the device was not operable. When I arrived at the NBS, one (1) single wire brush was not making contact with the commutator by about ½ of an inch, which was very obvious. It took me a few minutes with the aid of a pocket knife to secure the contact. An aide to Congressman Thomas Kindness' office was there and stated to the News Media he knew little or nothing about electrical technology but that even he would have known how to hook up the brush to the commutator.

Obviously, the claim by the NBS was false and simply a ploy to attempt to further cost me money and time and

hopefully to discourage my efforts for Justice. Moreover, the attorney for the Patent Office was there and told the NBS employees what to say and do "like puppets on a string."

- (10d) After the thirty days elapsed, my attorney, John Flannery, went to the NBS to pick up the device and return it to me, as the NBS had told him he could do and as ordered by and stressed by the Higher Court [see (10) above].
- (10e) When my attorney, John Flannery, arrived at the NBS facility on the morning of February 24, 1986, at 10:30 A.M., he found armed Marshals guarding the device with an order for my attorney to be in Thomas Penfield Jackson's Courtroom within approximately one hour or Jackson would send Marshals to arrest him.
- (10f) On arrival in Jackson's Court, my attorney received despicable injustice from Judge Thomas Penfield Jackson. Jackson ordered that he was **taking custody of the Invention Device**. This was clearly a flagrant violation of the Higher Court order! [See (10) above.]
- (10g) And even more contemptible on Jackson's part: **he was taking illegal possession of my property without due process of law!**
- (10h) To further flagrantly defy the Higher Court's order [see (10) above], Jackson stated that the NBS could **keep the invention until Jackson said otherwise**.
- (10i) My attorney, John Flannery, correctly and lawfully asked the Judge to recuse himself (Jackson) from the case because of demonstrated bias and prejudice.
- (10j) Jackson held my attorney, John Flannery, in "contempt!" This itself was clearly a violation of the law, concerning a Judge being accused of being biased and prejudiced by an attorney, especially when **the Facts show Jackson to be a Criminal of the worst kind!** Jackson's unlawful actions steal from the "People" of this Nation and the World. However, the Higher Court of Appeals again OK'd this Injustice.
- (11) My attorney, John Flannery, asked the Higher Court (Federal Circuit) on my behalf to remove Thomas Penfield Jackson from this case. Again, said Higher Court endorsed the Gross Injustice of Jackson by denying our request, which makes them every bit as guilty of crime as Jackson!
- (12) My attorney asked the Court to correct the violation of its order by Jackson, the NBS, and the Patent Office. The Higher Court (Federal Circuit) did nothing and has of this date done nothing. **Therefore, in my mind now as then, the Higher Court deliberately and premeditatedly set me up, lied to me and deceived me, by pretending to make reasonable guidelines for testing [see (10) above], so as to entice me to send the Invention Device to NBS.** Then after I had done so, they allowed Jackson, the NBS, and the Patent Office to commit the same gross injustices that the Higher Court had earlier condemned. [See (8a).]
- (12a) The NBS kept the device for 150 days, running secret tests, without me and my colleagues being present and failed to conduct any tests in the 30 days ordered for testing by the Higher Court of Appeals.
- (13) Thomas Penfield Jackson then set trial for December 8, 1986, which was more than **two years** past (6c) and (6e) above: Clearly two years of compounded Injustice and violation of Federal Law and of the Constitution.
- (13a) In protest of the lack of Justice in the Court of Thomas Penfield Jackson, I issued a Press Release stating that I would **not** attend the trial of my Pioneering Work and its Pioneering Invention that I had devoted 22 years of my life to in its perfection for Humanity. My absence from the Courtroom was for the purpose of accenting the absence of Justice in the Court of Thomas Penfield Jackson.
- (14) I wish to stress that it is not Thomas Penfield Jackson, the Higher Court, the NBS, or even the Patent Office individuals involved in this proven conspiracy that is the True Enemy of the People of this Nation, but rather **the Invisible Monster of Injustice** that allows such small-minded individuals to yield such a massive ax of Injustice against Humanity. That is my worthy opponent and my enemy and your enemy and the enemy of Humanity since time began.
- (14a) That is the enemy that caused caring individuals to write the Declaration of Independence.
- (14b) That is the enemy from which the Constitution of the United States strives to protect us.
- (14c) I stress to you that this Invisible Monster of Injustice is formidable and will crush and consume Humanity when and wherever it is taken for granted and not diligently watched for, searched for, and purged from society.
- (14d) What I have shown in the above facts is that this Invisible Monster of Injustice has filtered into the Highest Levels of this Government and the Courts, and stands as a Mockery of the Constitution of the United States and of the Declaration of Independence.
- (14e) There is no Senator — there is no Congressman — there is no Political Individual — there is no News Individual — there is no Human, who believes in Justice and Truth that can take these facts for granted. For one thing is sure, if it can happen to me, it can happen to you or yours and will most certainly continue ever-increasingly to others with

time, if not faced, sought out and purged from the highest levels of our Government and Courts.

- (14f) I demonstrate to you by what I do that this formidable Invisible Monster of Injustice can be exposed and made vulnerable for its own destruction.
- (14g) How to achieve this? Simple. Use your mind that God has given you to question, challenge, keep balances and checks, seek Truth and forge forward to its accomplishment.
- (14h) By what I do, I make this Invisible Monster accessible to you. It is all of the Good People of this Nation that must now quickly and expertly pull together and plunge the weapon of Truth into this Invisible Monster of Injustice and **remove from office** all who are found guilty of being a part of this attempted Injustice to Humanity.
- (15) For the purpose of further magnifying this Injustice, I refer to the trial discussed in (13) above. The trial lasted from December 8 through December 12, 1986.
- (15a) I did not attend my own trial. My extremely competent attorney, John Flannery, and competent Scientific Individuals, Dr. Roger Hastings (Physicist), Ralph Hartwell (Electrical Engineer) and Milton Everett (Mechanical Engineer) did a superb job in making the NBS and the Patent Office appear foolish, and proving that my technology and its Pioneering Invention work.
- (15b) By the Facts of the Trial Record, the NBS basically admitted that they had improperly conducted their testing. At one point the Patent Office even asked the Judge to postpone the trial and let the PTO employees have additional time to gather further evidence to disprove my technology, even though they had already had almost eight years. Their request was denied.
- (16) Now the clincher of Injustice compounded upon Injustice. The PTO recently presented a bill to the Court of Thomas Penfield Jackson asking that I pay the Patent Office \$102,181.95.
- (16a) \$98,649.26 of this \$102,181.95 was to supposedly pay for unlawful testing by the National Bureau of Standards (NBS) — testing which occurred beyond the ordered time of thirty days and testing which violated the conditions ordered by the Higher Court of Appeals. [See (10) above.]
- (16b) And even more ridiculous, the testing by the NBS employees was incorrectly performed, and the NBS will, for all of history, look ridiculous because of it.
- (16c) My instant response to this **criminal bill of \$102,181.95** is “Not No — Hell No!”
- (16d) This massive injustice shows and proves the corruptness and evil that is clearly traceable by the Facts back to (6c) above, which I quote again.

Jackson stated in the Court Record that the reason he was using a Special Master was to expedite the Summary Judgment and to save me money.

The unlawful actions by the Higher Court (Federal Circuit) encourage and endorse this massive injustice.

It should also be pointed out that presently there is **no law** that a Federal Judge has to act in making a decision in **any** reasonable length of time. Judge Jackson himself has been known to take over two years to issue a decision **after** the trial had ended.

- (16e) Prior to all of this, years of additional injustice was committed by Patent Office personnel and was applied throughout all the above, such as perjury and the continuous violation of the laws concerning the purpose of the Patent Office's existence: **To stimulate creativity in order to benefit the People of this Nation.**
- (17) The attorneys for the Patent Office in this case and Commissioner of Patents, Donald Quigg, have all lied, perjured themselves, and **should and must be prosecuted.**
- (17a) Thomas Penfield Jackson should and must be **impeached and prosecuted.**
- (17b) The Higher Court should and must be criticized and its involved personnel put on probationary performance or replaced.
- (17c) The Judges cannot be trusted to judge one another! When a Judge is accused by an attorney and his client for violating the law, twelve unbiased American citizens judge the claim, the very people who are affected by the decisions of a Judge's ruling.
- (17d) If a Judge is falsely accused then the accuser is punished triple of what would be normal.
- (17e) If a Judge is found guilty of violating the law, then said Judge is impeached by the “People,” whom the Judge is supposed to serve. He is not to be judged by his comrades! [See (7d) above.]
- (18) To exemplify how the Invisible Monster of Injustice weaves its web and grows like a fungus in darkened places if not corrected, I present other facts:

- (19) Michael Deaver, one of Reagan's closest friends and a top aide, was shown on National News in maneuvering a complicated legal tactic to delay his indictment on a Separate Criminal Case from the recent Iran-Contra scam.
- (19a) Once again, Thomas Penfield Jackson (Reagan's appointee and Watergate attorney) conveniently comes into the picture and takes an action that is apparently unheard of: stopping an indictment **before it ever occurs**.
- (19b) Look back at Sections (5a) through (5c). **The old saying "thick as thieves" comes to mind.**
- (19c) Michael Deaver had originally advocated the appointment of the independent counsel and then when he himself was found guilty of a crime before said independent counsel, he then filed suit to claim the independent counsel was unconstitutional and that President Reagan rather than the judiciary should choose the independent counsel that judges Michael Deaver.
- (19d) This is the same as a murderer saying, "I want my friend to choose my Jury or Judge."
- (19e) Representative Don Edwards of California said: "You can't expect the Executive Department to investigate itself, there's too much of a conflict of interest."
- (19f) John Dingell of the Commerce Oversight Subcommittee of Congress said: "For the courts to throw out a statute as important to the order and to the cause of justice in this country as a special prosecutor statute would be a calamity of the greatest order."
- (19g) Oliver North filed an identical suit as Michael Deaver (**one day before Deaver**) concerning the Iran-Contra scam. Question: Who is his Judge? Reagan himself gave Oliver North high praise. Look back at (19c) through (19f). The same Facts apply.
- (20) Ronald Reagan admitted on his latest TV address to the "People" that he was responsible for the wrong doings of his subordinates.
- (20a) I most certainly agree that Reagan is responsible! Especially since Reagan has personally, by the "Facts" — conducted himself so as to **encourage** their wrong and unlawful actions.
- (20b) Reagan stated to the People that there were **no records kept** concerning the Iran-Contra scam, which is very convenient, especially in light of the Fact that Watergate was exposed because records were kept.
- (20c) Reagan then told the "People" records are now going to be kept at the White House implying that you, the People, should be non-thinking, and **excuse prior violations of the law**.
- (20d) It is obvious that a law must be enacted that with **every action** undertaken by the White House, clear and accurate records must be kept.
- (20e) **Reagan should most certainly be impeached!** He has — by the "Facts" — deliberately encouraged the mass Injustices to me and to the "People" who are the recipients of this most beneficial technology to which I have devoted most of my adult life. (See quote from Reagan's own staff in (3) above: "some scientists believe this invention could change the world as it converts mass into energy — runs on its own energy.")
- (21) I gave a demonstration of my Pioneering Technology by running a 1800-lb automobile (with driver), demonstrating Electromagnetic Levitation, Weather Control and Causes, and much more at the Mississippi Gulf Coast Coliseum in Biloxi, Mississippi at 11:00 A.M. on March 11, 1987.
- (21a) Interestingly enough, my demonstration in Biloxi occurred on the **same day** Thomas Penfield Jackson made his ruling on the Deaver matter [see (19) through (19f) above].
- (22) To you, the reader, I am well aware that my Pioneering Patent Application is under the decision of Thomas Penfield Jackson yet to be handed down and after him the possible involvement of the Higher Court (Federal Circuit), both of which I condemn here. I go even further than that and point out that because of some of Reagan's record with respect to the type of compromising individuals he has placed in high positions, that this automatically makes even the two Reagan Supreme Court appointees suspect. These individuals' past records and possible outside influence connections should be carefully rechecked. It does not mean that they are automatically guilty, but at the same time honest individuals are not worried if they are checked out and a Supreme Court Judge should especially welcome a thorough investigation of his background if the Judge has nothing to hide.
- (23) Many people who read these facts may possibly feel overwhelmed or helpless. Open your mind and read what I have accomplished. How have I accomplished it? Simple. By using my mind, documenting the "Facts," and then acting on them.
- (23a) You, the reader, have a mind that can do the same thing. I am only one person, but I assure you that I feel absolutely no fear of what I do. In fact, just the opposite, the muscles across the top of my shoulders and down my arms quiver with anticipation at the thought of an opportunity to thrust this sharp deadly weapon of "Truth," which I pierce into the formidable **Invisible Monster of Injustice** that allows small-minded individuals to yield such a massive ax of injustice to Humanity.

- (23b) If all people of this nation do exactly as I do, then no corrupt politician or Judge can exist against your might. The Invisible Monster of Injustice will not be able to get small-minded individuals to serve injustice to you the "People." This formidable Invisible Monster will always be there to entice government employees whereby the People must always be alert, keep balances and checks, and take nothing for granted.
- (24) Abraham Lincoln stated what must be done: "We the people are the rightful masters of both Congress and the Courts — not to overthrow the Constitution, but to **overthrow men** who pervert the Constitution."
- (24a) Everyone who reads this material and agrees with its message should seek to get it published in papers, magazines, and read on talk shows. And to be absolutely sure of distribution, make at least five copies and send them to other individuals asking them to do likewise.
- (24b) Everyone who reads this material should contact their Senator and Congressman, and ask them to actively see justice served to you, the "People."
- (24c) Do not be deceived by any politician who may try to excuse the Factual Massive Injustices described above. Do not be deceived by their words or lack of responsible action. Recognize that such politicians are the endorsers of said Injustices and come election time then you, the People, **remove them**.
- (25) **Be assured that "Truth" is like a High Intensity Laser Beam and it will burn through garbage!**
- (25a) I believe that physicist Dr. Roger Hastings' comment concerning the benefits of my technology to Humanity is appropriate in more than one way: "If you have any conscience at all, you cannot walk away from this."
- (26) I conclude this Press Release and tribute to the Bicentennial of the Constitution with the same words at the beginning and end of my book: "To all Peoples whose brain burns and aches to accomplish great things and changes for the good, may God and/or the Goodness of the Universe be with you. For you are the Goodness of the Universe and do good for the People in spite of themselves. And I salute you!"

And I sign my name to the destruction of Injustice as John Hancock signed his on the Declaration of Independence July 4, 1776.

Joseph Westley Newman

Joseph Westley Newman
March 6, 1987



PROOF THAT MY INVENTION WORKS:

Joseph Newman challenges anyone to run an 1800-lb automobile powered by a conventional electric motor with the current equivalent to that from a 1½-volt transistor battery.

By using his energy machine motor, Joseph Newman has already run an 1800-lb automobile with the current equivalent to that from a 1½-volt transistor battery!

As Dr. Hastings said: "If you have any conscience at all, you can't walk away from this."

- (27) On March 11, 1987, the automobile powered by the energy machine performed as stated above in the Biloxi, Mississippi COLISEUM and as verified on national CBS EVENING NEWS.
- (28) On March 11, 1987, Thomas Penfield Jackson ruled ambiguously concerning Michael Deaver [see (18)-(20) above] which encouraged Deaver to further stall his indictment with Deaver now saying that he would go to the Higher Courts to fight the **issuance** of his indictment. The ambiguous nature of the Judge's actions was discussed and analyzed on the March 11, 1987 Wednesday evening MacNEIL-LEHRER NEWSHOUR.
- (28a) Obviously, Thomas Penfield Jackson has opened a "Pandora's Box" by his unprecedented action to stay the indictment of Deaver by a Federal Grand Jury. Such action now opens the doors to appeals and other indictment-delaying tactics by Deaver's attorneys and only further multiplies the injustice to the People.
- (28b) Regardless of the future outcome by the Higher Courts in the Deaver case, Thomas Penfield Jackson has attempted and has succeeded as of this writing in making a mockery of the Justice upon which this country is founded.
- (28c) Recognize that Deaver's purpose is to have one of his closest friends and former boss, **Ronald Reagan**, pick the individual or individuals who will judge him!
- (29) **Further incriminating evidence:** Through his Subcommittee on COURTS, CIVIL LIBERTIES, AND THE ADMINISTRATION OF JUSTICE, Congressman Robert Kastenmeier has been circulating an unsigned letter on an 8½" x 11" sheet which even lacks a letterhead. This letter is being sent to people who call his office to request that as Subcommittee Chairman he schedule a hearing on the Joseph Newman legislation. The letter specifically states:
- "You should also know that official representatives of President Reagan have indicated their opposition to Mr. Newman's private relief bills. Thus, unless the President changes his position, legislation on this topic is unlikely."***
- (29a) The questions to be asked are: 1) Who are these "official representatives" of President Reagan? 2) What is the specific nature and reasons for their opposition? 3) Why is a Democratic Congressman so concerned about the opinion of a Republican President concerning this legislation? **IS CONGRESSMAN ROBERT KASTENMEIER LYING OR TELLING THE TRUTH?**
- (29b) The old saying "birds of a feather flock together" comes to mind. Kastenmeier has vowed to stop all House Bills for Joseph Newman's Pioneering Patent. **Kastenmeier endorses the injustice to the People initiated by the financial power brokers that manipulate and influence unethical and unlawful Senators, Congressmen, and/or Presidents.**
- (30) You the People must act. See (24) above: "We the people are the rightful masters of both Congress and the Courts ..." This is **not** a Democratic or Republican issue. It is an issue of Justice to and of the People.

★ For those who cannot understand why I fight so hard for the benefit of others, and do not tire or cannot ★
 ★ be intimidated, please read the attached tribute to my great-grandmother. Look into her eyes and you ★
 ★ will realize that what I do is natural to me and it would be difficult for me to do otherwise. ★



Aunt Prudie Ladner, "doctor" of the back woods, who delivered, nursed, cured and inspired hundreds of Mississippians during her long life, posed for this picture with her husband, a teacher, when she was about 40 years old.

Mother OF SOUTH MISSISSIPPI

THE TIMES-PICAYUNE NEW ORLEANS STATES MAGAZINE

It is said that every middle-aged man and woman within a 300-square-mile section of South Mississippi came into the world under the gentle ministrations of Aunt Prudie Ladner, unsung heroine of the backwoods, whose life of great service reads like a classic of pioneer fiction.

For over 60 years Aunt Prudie, a small and twinkling blonde, was a redoubtable buffer standing between pain and the farmers of the countryside around Lumberton.

She was more than a midwife, was Aunt Prudie; she was a doctor, as well versed in things medical as many a qualified physician, although she placed her greatest trust in herbs and roots which, after all, were often the same medicinals as those handed out by the physician in a different form and disguised with a Latin name.

As courageous a human as ever loved the red clay hills, Aunt Prudie often braved the night alone on horseback, swimming flood-swollen streams, slipping and sloshing through bottomless gumbo, to reach the bedside of an expectant mother or dangerously ill child.

In all, Aunt Prudie during her 65 years of practice, delivered 2914 babies and nursed back to

health unnumbered thousands in a territory which included parts of five counties — Lamar, Pearl River, Forrest, Marion, and Stone.

Prudence Smith Ladner was born in 1852 in Smith County, Miss., and was taken when a child to Mobile, Ala. She returned to Mississippi as the 16-year-old bride of P.A. Ladner, and settled with him near Lumberton.

Prudie, young as she was then, was an expert midwife, and she entered into practice. As there was no "diploma" doctor within 50 miles, she soon was called upon to treat illnesses — malaria, boils, dysentery, tonsillitis, and the mysterious fluxes and brain fevers of the day.

Prudie — not yet "Aunt" Prudie — took to reading "doctor" books and experimenting with ancient folk remedies. As the years went by she tried and proved to her satisfaction many a crude but effective treatment, using the natural materials that grew in the woods and fields about her.

For a kidney flush she brewed a tea of "four corners of the earth," a grass. Boils were brought to a head with tar salve; malaria was attacked with a tea brewed from the black snake root. Fever grass root was an admirable, if violent, purgative. Ton-

sillitis called for a gargle made of persimmon bark, red oak bark and salt. Dysentery disappeared after a dose of tea made from red oak bark and blackberry root.

Aunt Prudie regarded herself as a mere instrument of the Lord. She coveted no secrets, was willing to teach her skills to anyone who sought to learn. Her energy was unlimited. Besides ranging as doctor throughout the countryside, she had time to tend the farm chores and give birth to nine children of her own.

Mr. Ladner, her husband, is said to have looked upon his wife with awe, but he was not completely overshadowed by the strenuous woman he married. At his home he set up a school, the only one within miles. Among his pupils was young Theodore Bilbo, future senator, whose youthful ailments were soothed by the wife of his schoolmaster. When public education spread to the piney woods, Mr. Ladner for many years was supervisor of a Pearl River county district.

Legends were spun around Aunt Prudie while she still was a young woman. Not legend but fact, however, is the story still told about the night her horse slipped in a storm and fell on Aunt Prudie, breaking her foot. Instead of returning home for help she continued to her destination, was carried

from her horse into a house where she delivered a baby, then was carried back to the horse which she rode home.

"Aunt Prudie was sure the mother of this county," remarked one old timer, himself delivered by her. "She was a lot more 'n jest a midwife. She give us advice on everythin', she made us believe in the power of prayer. If we couldn't pay her, she treated us anyways."

And Prudie was also the jolliest citizen of the hills, a lively, bubbling person whose laughter and capering were the making of many an otherwise routine shindig.

Mr. Ladner died in 1916, and Aunt Prudie took over the entire management of her bulging household. As the years passed and grandchildren came, she grew stout and was no longer able to make the tortuous trips across country astride a horse. But until she was 80 years old she was always eager to do battle with fear and pain.

Aunt Prudie died in August, 1945, at the age of 93. She left seven children and 35 grandchildren — her family can not agree on how many great-grandchildren. She left also a glowing memory in the hearts of the thousands she aided in her six decades of doctoring.

Newman clearly teaches that the best system design is the one in which the least amount of energy inputted into the conductor causes the greatest amount of atom alignment.

FACT 6: The **current and power (wattage) input consistently decreases** as the number of turns of **atoms comprising the coil increases** and yet the strength of the energy of the magnetic field **never** decreases. Simply put, the **same** strength magnetic field can be produced while **infinitely decreasing** the current and power (wattage) input.

Note that there is 10,000 times more current and wattage consumed in the 1st equation than in the 4th equation, while at the same time the conductor of the 4th equation has 10,000 times more atoms than the conductor of the 1st equation.

CONCLUSION: The above information gives absolute proof that the current and power (wattage) consumed to produce a given energy strength magnetic field associated with a conductor is inversely proportional to the number of atoms comprising the conductor. Simply put: *this proves that the magnetic field comes from the atoms of the conductor, exactly as Joseph Newman teaches ($E = MC^2$)*

This technology represents a means of converting mass into pure energy on a 100% conversion process in accordance with Einstein's equation of $E = MC^2$ without **any** pollution to the environment or to the Human Race. This opens a universe of excitement and a magnificent future for the Human Race!

FACT 7: The accuracy of the above mathematical results relating to Joseph Newman's technology are confirmed by those results being applied for any reasonable length of time (for instance, one month) and you the consumer having to pay for the wattage consumed. Example: The current (amps) and wattage consumed in the 1st equation is 10,000 times greater than that consumed in the 4th equation and yet the **same** energy strength magnetic field is produced. (See Facts 4 and 6 above.)

FACT 8: The engine powering the automobile being demonstrated is running off 30 gauge wire and strong magnets in accordance with Joseph Newman's Teachings. As proven above, anyone who wishes to use one's mind will recognize that the automobile will operate as stated, even before seeing it for oneself. Why? Because Joseph Newman has more than 113,000 turns of 30 gauge wire (more than 200 lbs. of copper atoms) and more than 300 lbs. of constant permanent magnetic atoms in his motor.



ORLEANS PHOTOGRAPHY

PROOF THAT MY INVENTION WORKS:

Joseph Newman challenges anyone to run an 1800-lb automobile powered by a conventional electric motor with the current equivalent to that from a 1½-volt transistor battery.

By using his energy machine motor, Joseph Newman has already run an 1800-lb automobile with the current equivalent to that from a 1½-volt transistor battery!

As Dr. Hastings said: "If you have any conscience at all, you can't walk away from this."

On March 11, 1987, the automobile powered by the energy machine performed as stated above in the Biloxi, Mississippi COLISEUM and as verified on national CBS EVENING NEWS.

FACT 9: In addition to the Fact that Joseph Newman's challenge in Fact 8 above cannot be accomplished by conventional teachings of electric motors, there will be a DC amp meter, an AC amp meter and a RF amp meter hooked in series and they will all prove that more energy comes out of the engine than is inputted into the engine by the battery pack of high voltage and low current capacity (current is equivalent to that in a single 1½-volt transistor battery).

FACT 10: These battery packs of High Voltage and Low Current have been built by RAY-O-VAC Battery Company for Joseph Newman and they are all numbered with "Experimental Battery" written on the top.

FACT 11: A National News Conference will be held at 11:00 A.M., Monday, April 6, 1987 in Atlanta, Georgia at the Georgia International Convention & Trade Center, 1902 Sullivan Road, College Park, less than 1 mile from Atlanta Int'l. Airport near the intersection of I-75 and I-85.

FACT 12: The public is also warmly invited. The automobile will be run hour after hour until the special Battery Pack fails. The automobile has already run 10 hours on this special Battery Pack and it is expected to run 15 to 40 hours or more before the Battery Pack fails. At the same time, the facts of the meters (see Fact 9) prove that more energy consistently comes from the engine of the automobile than from the Battery Pack.

The dry cell battery pack is not considered to be rechargeable so it will, at some point fail, regardless of the fact that there is more energy going back into the battery pack than energy coming from the battery pack. RAY-O-VAC Battery Company is working diligently with Joseph Newman to correct this conventional deficiency and results look very good.

FACT 13: The automobile will be running at a slow speed (walking speed) but keep in mind it will be running off the current equivalent to what is in a 1½-volt transistor battery the size of your thumbnail.

The automobile will be stopped at 9:00 P.M. each night and will start again at 9:00 A.M. each following morning until the battery pack expires. The initial start will be at 11:00 A.M., Monday, April 6, 1987. The batteries will be checked by the News

Media to be sure that they have not been changed and will also be verified by representatives of RAY-O-VAC Battery Company.

FACT 14: Joseph Newman will be talking and demonstrating the breadth of his Revolutionary Technology concerning gravity — space travel — weather and other tremendous beneficial changes that can and will occur as soon as the “People” of this nation get behind the technology that Joseph Newman has devoted 22 years of his life to bringing forth to the Human Race.

Joseph Newman asks the News Media to attend, verify, and monitor this historical event and to make the “People” aware of the event, so that they and their children can come, see the beginning, and then come and go as often as they desire to verify the extraordinary results of the time the automobile runs off the current equivalent to what is in a 1½-volt transistor battery, the size of your thumbnail.

The U.S. Government has deliberately stifled and continues to vigorously stifle this technology from the “People” of this nation and the world. Therefore, Joseph Newman takes the Technology to the “People” so they can see it and judge for themselves.

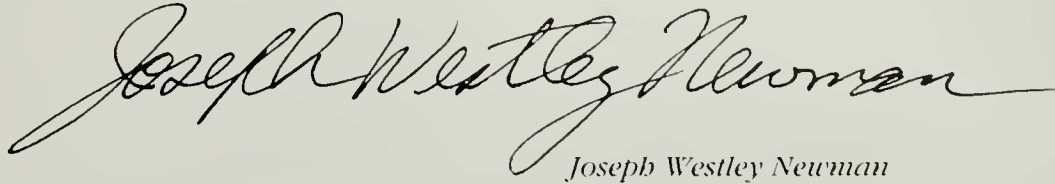

Joseph Westley Newman

**For further information, contact: Joseph Newman at (601) 947-7147
Route 1, Box 52, Lucedale, Mississippi 39452**

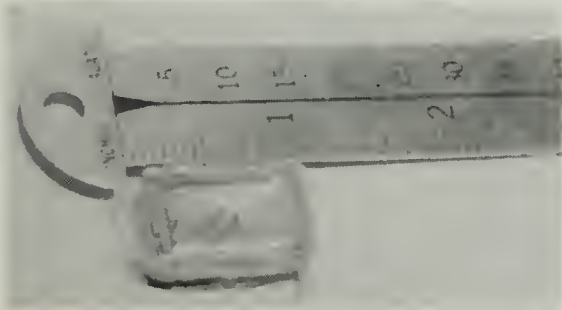

1½-VOLT TRANSISTOR BATTERY

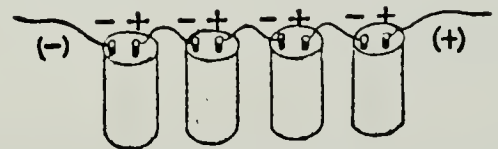

CELLS IN SERIES

POSTSCRIPT:

Prior to the Atlanta presentation of the electric automobile, a representative from RAY-O-VAC prepared a chart which described the life expectancy of the batteries designed and built by RAY-O-VAC battery company. According to RAY-O-VAC, the batteries should be dead after 25 hours of supplying 20 milliamps to the energy machine coil in the automobile.

Before going to Atlanta, the car operated for 10 hours on the same set of batteries. While at Atlanta, the car operated for an additional 20 hours, 10 minutes on the same set of batteries. Upon returning to Lucedale, Mississippi, the car operated for an additional 45 minutes on the same set of batteries. Consequently, the total battery time of 30 hours, 55 minutes exceeded the theoretical life expectancy of the batteries by over five hours. Moreover, at the end of the Atlanta presentation, the RAY-O-VAC representative tested the batteries and found them to still have substantial energy content!

Two of the batteries designed by RAY-O-VAC were rendered physically inoperative by the back-charging effect of this system. The RAY-O-VAC representative will have his company carefully study these results with the intent of designing a battery that can withstand the back-charging effect of this system.

[The following sections have been added to the Sixth Edition]

XXIII.

The Fifth Edition of THE ENERGY MACHINE OF JOSEPH NEWMAN — which represents my Life's Work for Humanity — was published and sent out over two years ago. The additional information added in the following sections fits perfectly with all that has been written in the earlier Editions of this book. Some of this new information will shock you! The reason:

The new information deals with factual Proof that the Decade of the 1990's will decide if we go into 1000 years of Peace preceded by the 1990's being almost total destruction of most life on Earth, or if we decide to choose Love and Peace between All Peoples on this Earth as our way of life for the 1990's and into the following 1000 years of Peace.

If you refer back to page 154 of this book you will read that I thought my life's work, i.e., the technology I teach, would have seen worldwide use and that I would be dead and gone by the time people examined what else I had to say about Life that may also benefit them and their families. On page 154 I wrote:

"TO ALL WHO 'MASTER' AND ARE INSPIRED BY WHAT I HAVE TAUGHT, IN THE REMAINDER OF THIS BOOK I SPEAK TO YOU:"

(These words prove that my Technology means nothing if the Values of the Human Race do not IMPROVE!)

Following these words I present my whole Philosophy of Life and Happiness. This Philosophy relates exactly with what follows in this added section to the new Sixth Edition. Why? Because in 1987 God started speaking to me mentally just as every preacher now claims and has claimed throughout the history of all people upon this Earth.

Turn to page 252 of this Book wherein I explained how easy it was for God to communicate with each of us and vice versa — Electromagnetically. I wrote and published this in 1984!

In 1987 God began communicating with me by direct, electromagnetic, mental communication which instructed me to serve all of God's People upon this Earth. The reader should also refer back

to the page before the Preface of this book — my Life's Work — wherein I wrote:

"DEDICATED TO ALL THE PEOPLES OF THE WORLD WHO LIVE AND ARE YET TO BE BORN."

It is now obvious to me and I hope becomes obvious to you that it is NO accident that I felt compelled in 1984 to so dedicate this book containing my Life's Work with the aforementioned words.

God has made me from birth — has taught me — has inspired me — has made me sensitive to ALL PEOPLES OF THIS EARTH. God has chosen me to serve you — to serve ALL PEOPLES.

Since the end of 1987, I have followed God's direction and began warning the world of God's Innate Wrath which will befall us if we do not love one another. As a result of my actions and warnings most of my loved ones and most of the news media throughout the world have turned against me and my Life's Work. So have many of my previous so-called friends. Even my wife Ellen and my son Gyromas have turned against me and left. I married another girl — Annis — who in the last couple of months has also totally turned against me and left! Even one of my daughters turned against me. However, my other daughter — Michelle — has stood by me lovingly and courageously. Michelle lives in another state. Now, in fact, I sit totally alone (except for the Presence of GOD) in the woods on Sunday afternoon June 3, 1990 writing this portion of my Life's Work for ALL Humanity.

God makes me into "STEEL" whereby I can best serve ALL HUMANITY and never 'miss a beat' of service to God and Humanity even when others around me fall away because of the hardship God has asked me to endure for his Peoples of the World.

My desire to serve God and Humanity was also exemplified by the 26-page Red-Covered Press Release which I sent out around the world in 1987. This Press Release concerned then-President-Reagan's and the U.S. Government's effort to steal and stifle my Life's Work and Energy Machine Technology. The following Red-Covered Press Release is now inserted into this addition to the Sixth Edition:

**ONE OF THE
HOTTEST NEWS STORIES
IN THE HISTORY OF THE WORLD!**

(cannot be said in a few sentences)

See **FACT 45** for very possibly the next United States President
as an independent, **TRUTH AND ACTION PARTY.**

JOSEPH NEWMAN PUBLISHING COMPANY

Route 1, Box 52
Lucedale, Mississippi 39452
(601) 947-7147

FOR IMMEDIATE RELEASE

FOR IMMEDIATE RELEASE

★ ★ ☆ ★ ★ SUPERCONDUCTIVITY — THE REAL TRUTH ★ ★ ☆ ★ ★

**THE GREATEST ATTEMPTED FRAUD AND THEFT IN THE HISTORY OF THE WORLD!
FOR MORE THAN 8 YEARS, INVENTOR JOSEPH NEWMAN HAS SPENT OVER \$1,000,000.00
FIGHTING THE U.S. GOVERNMENT IN ORDER TO BRING THIS TECHNOLOGY FORWARD!**

Joseph Newman compliments Dr. Paul C.W. Chu of the UNIVERSITY OF HOUSTON for "Mastering" aspects of his Pioneering Technology and, at the same time, Joseph Newman condemns Dr. Chu for claiming Pioneering credit for a technology to which Dr. Chu is not entitled.

Joseph Newman charges a number of top U.S. Officials and others with attempted theft (under the guise of "Superconductivity") and cover-up of his Pioneering Technology.

The recent advancement in Superconductivity is a direct result of inventor Joseph Newman's **Pioneering** 22 years of dedicated work.

I, Joseph Newman, back up my statements with "Fact" — exactly as I do in Science. [See the following information for more detailed Proof of these statements!]

FACT: Let's examine the history of Superconductivity development and see how its history matches the facts —

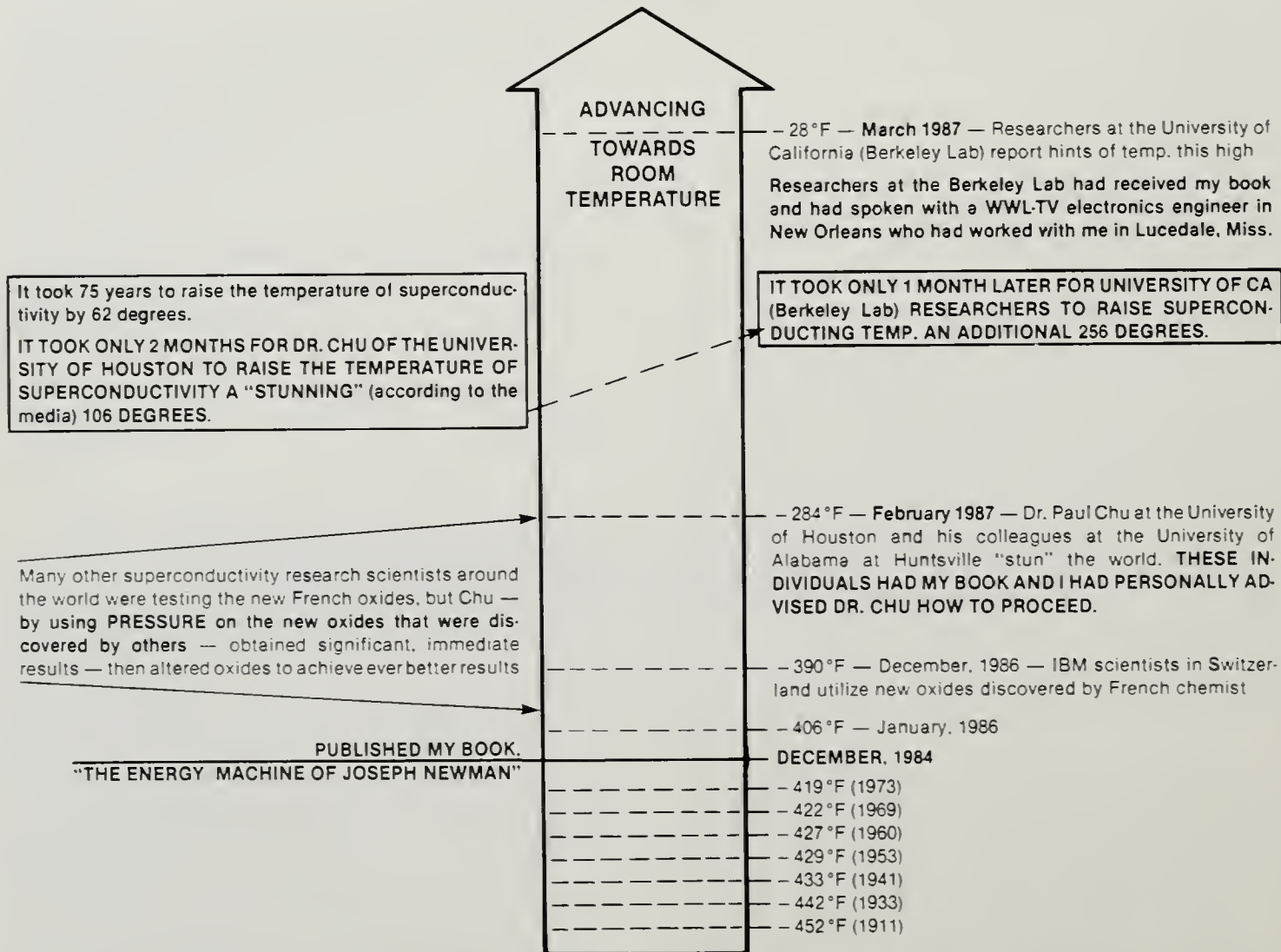

★ For further proof of the "Truth" of the facts presented in this Report, see page 22 for the extensive list of organizations, universities and corporations that have purchased my book.

SUPERCONDUCTIVITY — THE REAL TRUTH

THE GREATEST ATTEMPTED FRAUD AND
THEFT IN THE HISTORY OF THE WORLD!

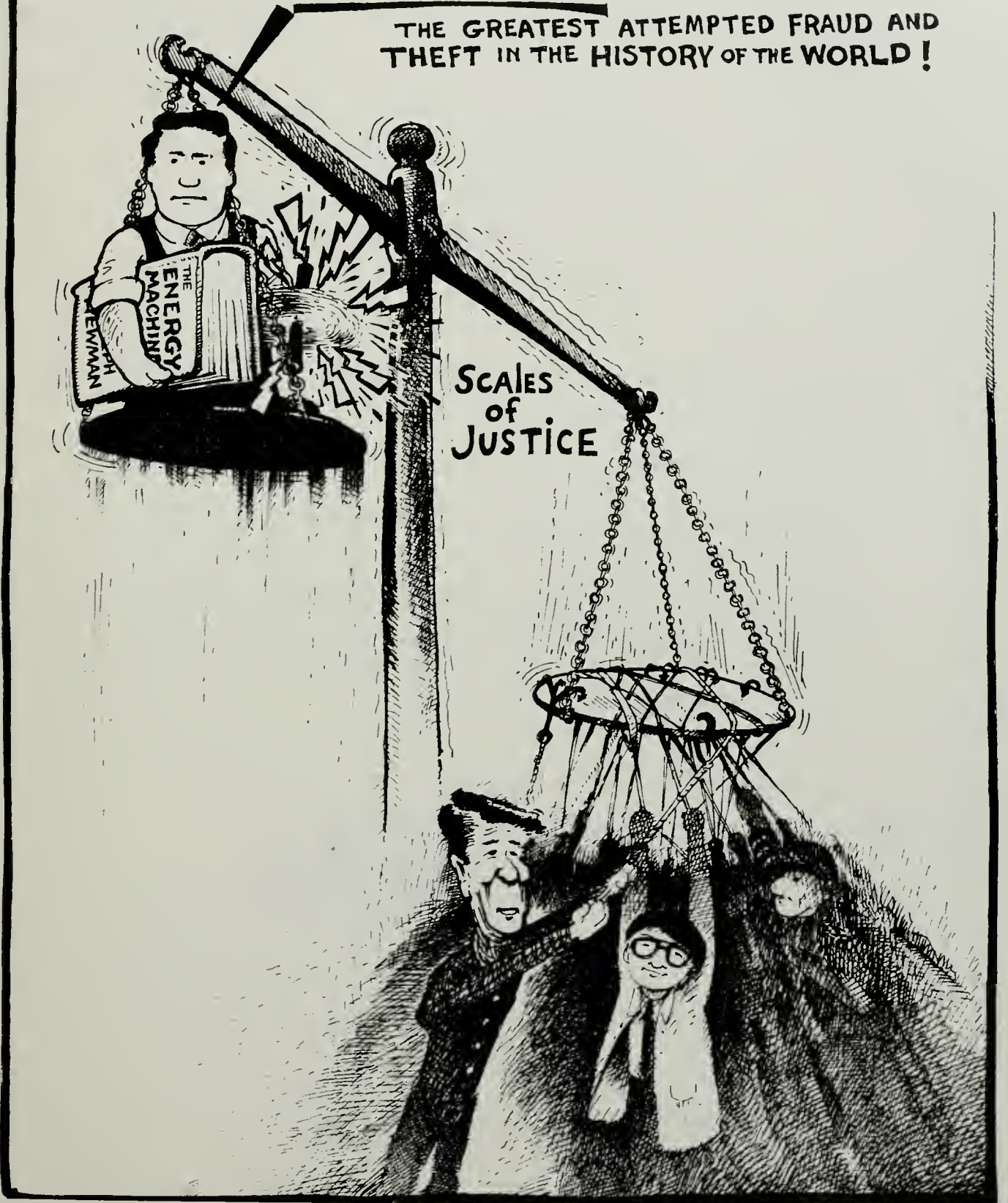

★ For further proof of the "Truth" of the facts presented in this Report, see page 22 for the extensive list of organizations, universities and corporations that have purchased my book.

SUMMATION OF WHAT YOU WILL READ

There has been a definite, continuous cover-up and attempted stifling by High Officials of the U.S. Government of the advancement of the Pioneering Technology resulting from my life's work. These actions now lead to an attempted theft.

EXAMPLE:

As featured on pages 166, 167, and 168 of my book ("The Energy Machine of Joseph Newman"), I sent a sincere letter and extensive, detailed material concerning my Pioneering Technology and its tremendous benefit for humanity to Ronald Reagan on November 17, 1983.

Featured on page 169 of my same book is a short, typewritten response from the White House dated 1985, March 21:

THE WHITE HOUSE

WASHINGTON

March 21, 1984

Dear Mr. Newman:

On behalf of President Reagan, I want to thank you for your letter and enclosures.

The President appreciates the time you have taken to bring your invention to his attention. However, I am sorry that this must be a disappointing response to your request. So many similar requests are received that it just is not possible to comply. I hope you will understand.

With the President's best wishes,

Sincerely,

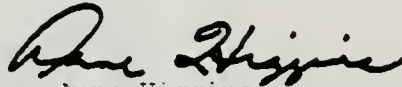

Anne Higgins
Special Assistant to the President
and Director of Correspondence

Mr. Joseph Westley Newman
Route 1, Box 52
Lucaedale, MS 39452

★ For further proof of the "Truth" of the facts presented in this Report, see page 22 for the extensive list of organizations, universities and corporations that have purchased my book.

When I received the material returned from the White House, everything was neatly packaged as though the vast material I had originally sent had never been opened.

Upon separating the vast material and filing it in the proper files, I discovered a White House "Goof-up" — an In-house handwritten Video Review of a VHS tape neatly stacked in the vast material I had sent.

The White House "Goof-up" entitled "VIDEO REVIEW" was obviously in total conflict with the letter sent from Anne Higgins, President Reagan's Special Assistant.

VIDEO REVIEW

Name of Sender: Joseph W. Newman

ADDRESS: RT 1, Box 52 Lucedale, Miss 39452

Date Received by the White House: 11-21-83

DATE REVIEWED: 3-3-84 INITIALS OF VIEWER: GTK

VIDEO SENT TO: RR/NR/ WHO? R.R.

Summary: A new energy source - Electric -
Magnets' device - Glenn Stearns requested
funding - Needs help to get US Patent
Some Scientists believe this invention
could change the world as it converts
mass into energy - runs on it's own energy.
WWL TV - Channel 4, New Orleans gave it
sufficient coverage.

If nothing unusual send directly to Lillie Bell, Room 58. Make a copy for JCD's file.

✓ Special cases to Chuck Donovan, Room 94.

Problems, i.e. threats etc. send to Secret Service Room 45 via Bob Gallagher.

Keep original form with video.

Anything intended as a gift, i.e. a professional production, Bible tapes, send directly to the Gift Unit, Room 457.

★ For further proof of the "Truth" of the facts presented in this Report, see page 22 for the extensive list of organizations, universities and corporations that have purchased my book.

It is quite obvious to me that the "VIDEO REVIEW" which stated: "Some Scientists believe this Invention could change the World," was in direct conflict with the statement "So many similar requests are received that it just is not possible to comply," by Anne Higgins.

Even at the time I received the letter from Anne Higgins in 1984 — and in light of the extensive U.S. Patent Office violation of the law which I had already experienced — I was left with no other logical conclusion than that there was a deliberate cover-up and attempted stifling of my Pioneering Technology for "Humanity."

See the following reduced-size reprint of my November 17, 1983 letter to Ronald Reagan which demonstrates my sincerity and the comprehensive nature of the materials I had sent to the White House.

November 17, 1983

Route 1, Box 52
Lucedale, Mississippi 39452
Phone: (601) 947-7147

President Ronald Reagan
Page two
November 17, 1983

President Ronald Reagan
The White House
Washington, D. C. 20025

Dear Mr. President:

This letter is written with literally years of experienced knowledge that I will probably receive no responsible, exacting actions relative to this request.

You will be the fifth President I have written regarding a New Source of Energy and the fifth President which I have asked to help me help the people of this country and the people of the world.

For over 18 years I have stood alone against a closed-minded scientific community and great odds.

My Government has given me absolutely no help, but to the contrary, has stood in my way and still continues to do so at the level of the U.S. Patent Office.

I now have several working prototypes of this New Energy Invention!

Please find enclosed copy of a letter I sent to President Johnson, dated July 31, 1967.

Also a copy of a letter, dated July 30, 1982, I sent to Mr. Paul Gomory (Expert Advisor on Patent Law for the Judiciary Committee of the Congress) and a copy of Mr. Gomory's reply to my letter which he sent to Mr. Ralph Oman, Staff Director, Criminal Law Subcommittee, Committee of the Judiciary.

Also find enclosed copy of my listing in the Physics Section of Who's Who In Technology, 1980 Edition, and numerous copies of letters from credible Scientific Individuals concerning

my scientific work, even before I built these prototypes, and which refers to a Scientific Document (Now 130 pages long), which puts forth a Unified Field Theory on all Matter. And copies of letters from credible business associates concerning my honesty and integrity and inventive ability.

Most important, find enclosed a VHS tape of news coverages made by Mr. Garland Robinette of WWL-Television (C.B.S.) of New Orleans. There are eight news coverages and one human interest coverage on this tape. Mr. Robinette has conducted himself in a most scientific manner relative to the facts on which he has reported, he has taken nothing for granted, but checked out all facts. Any others who give an opinion disagreeing on this matter, without doing equally as well, only reflect poorly on themselves and does an injustice to the peoples of the United States of America and the peoples of this world. I recommend that you view this tape before you pass this information down to some lower office as has always been the case in years past. This tape is approximately 30 minutes long.

My patent attorney is Mr. Emmett Pugh of New Orleans. Phone Area Code 504 - 581-2526.

Mr. Paul Gomory can be reached at Area Code 301-320-4327.

Mr. Robinette can be reached at Area Code 504-529-6300.

Patent Officials of U.S. Patent Office have deliberately ignored the requirements of the Patent Law Procedure relative to their own actions relative to the issuance of this Pioneering Patent on a New Energy Source.

I wish for the Commissioner of Patents to have to explain the actions of U.S. Patent Office, with me present, in front of the Judiciary Committee or the President.

I ask that you, Mr. President, have someone of honest integrity check out these facts in an exacting, scientific manner and to enact responsible actions accordingly.

I still stand alone, no doubt I will have to continue to do so, until all is accomplished as a result of my efforts. How sad that millions of others suffer in the mean time and the world stands on the threshold of total destruction.

President Ronald Reagan
Page three
November 17, 1983

This invention will be the cause of the Industrial Revolution all over again, except at a greatly accelerated rate, and will do more to reduce the possibility of war than any and all other means existing at this time, space travel will become a true reality, and will touch and excite all aspects of Science and will open many doors to the mind that have been closed before this time.

Sincerely,

Joseph Westley Newman
Joseph Westley Newman

JWN/en

Enclosures

★ For further proof of the "Truth" of the facts presented in this Report, see page 22 for the extensive list of organizations, universities and corporations that have purchased my book.

The plot thickened when I went to Federal Court in search of Justice. The plot has thickened even to this very day concerning an attempted theft of my work under the guise of "Superconductivity."

EXAMPLES:

As paraphrased in context from the article entitled "*No Resistance to Superconductivity*," in SCIENCE NEWS, Volume 132, pages 84 and 85, August 1987:

'Recently, Sound appeared to travel faster than the Speed of Light in Washington, D.C. in Reagan's attempts to spearhead a pack of political proposals concerning "Superconductivity.'

'Reagan presses for legislation to violate the *People's right to know* (i.e. to restrict and/or eliminate the People's rights under the FREEDOM OF INFORMATION ACT) about technology of commercial value.'

[End of paraphrasing.]

The Facts indicate that Reagan has already operationally connected Joseph Newman's Pioneering Technology to "Star Wars Technology" by means of a 'Web of Deceit' involving the University of Alabama and the REDSTONE ARSENAL MISSILE COMMAND (both located at Huntsville, Alabama), Dr. Paul C.W. Chu at the University of Houston, and others. If Reagan can push a Bill through Congress and the Senate to violate the People's "Right to Know" via the FREEDOM OF INFORMATION ACT, the the deceit can be kept from the People.

With this background, I now continue with additional facts of the Proof I present:

SUPERCONDUCTIVITY — THE REAL TRUTH

The importance of the issue of superconductivity is underscored by an article in THE NEW YORK TIMES, March 10, 1987 entitled "*Electricity Rushes Into A New Era of Discovery*."

For the last several years, I, Joseph Westley Newman, have consistently and vigorously stated that the injustice against me and the People concerning my Pioneering Energy Invention would make the Watergate scandal appear "*as a molehill to a mountain*."

The old saying, "**Give a thief or a liar enough rope and they will hang themselves,**" comes to mind. The following facts demonstrate this to be true:

FACT 1: I have persistently stated on a worldwide basis that I have innovated a New Source of Energy which converts mass to energy on a 100% conversion process utilizing Einstein's principle of $E = MC^2$.

FACT 2: The U.S. Patent Office, the U.S. government, and many conventional scientists said that this was "impossible."

FACT 3: I have persistently stated that this 100% conversion process was achieved by tapping into the basic building block of matter — the energy (gyroscopic particles) comprising a magnetic (electromagnetic) field. I also disclosed that this energy in a magnetic (electromagnetic) field was literally "a river of energy" that could be tapped for the immediate benefit of humanity without pollution to the environment or the human race, would end hunger, would make space travel commonplace, and much more. Also, this technology will do more to bring about "World Peace" than all the Kings, Queens, and politicians that have ever lived. I have continually stressed that the U.S. government should be the first to support this **Pioneering** breakthrough so that the People here and everywhere would be phenomenally benefited. As a result, the United States would once again gain the respect of other countries and the people of the world.

FACT 4: Some of the so-called "leaders" in the U.S. have responded to my efforts by misappropriating \$100,000.00 from the Department of Energy to fight my Pioneering Technology and deliberately lie, perjure themselves, perform incompetent tests, falsify documents, violate Patent and Federal Law, and keep me tied up in Court to this very day. Over the past few years, such opposition has cost me over one million dollars in expenses necessary to keep pushing this **Pioneering** Technology forward for the People of the World. At the same time, such opposition slows down my efforts to further this technology since I must spend time fighting such criminal injustice.

I have no doubt that it is their intent to delay the advancement of this technology in any way possible. Such delay gives 'energy concerns' the time to realign capital assets into areas convergent with my technology. Such delay also gives the opposition time to figure out a way to steal the technology for their own use and control. The damage of such theft to Joseph Newman is small by comparison to the damage done to you, your descendants, and to civilization. Such theft will sap the incentive of future innovators who would otherwise bring forth products and advancements to benefit all humanity. It is for such innovators and the People of the World that I fight such criminal injustice.

★ For further proof of the "Truth" of the facts presented in this Report, see page 22 for the extensive list of organizations, universities and corporations that have purchased my book.

FACT 5: In order to counter this massive injustice and deliberate criminal action/cover-up by government employees from patent office bureaucrats to President Reagan, I published in 1984 (with the valuable assistance of Evan R. Soule, Jr.) my **Pioneering** Technology in a book entitled "**The Energy Machine of Joseph Newman.**" The information in this book was developed over 19 dedicated years of my life. [As of this writing — 22 years.]

Before publishing my book — THE ENERGY MACHINE OF JOSEPH NEWMAN — everyone with whom I was in contact advised me not to publish since they were fearful that there were many unscrupulous individuals who would attempt to steal my life's work.

To my concerned friends and associates I responded instantly and consistently: the information was too important to humanity to be in the mind of only one man and *must* be published!

FACT 6: I fought vigorously for the expansion of this technology and my work has been featured in hundreds of newspapers and magazines across the United States and the world. In addition, I have appeared on national television and have been interviewed on numerous radio talkshows through the U.S. and Canada. Many of these interviews were taped and played around the world.

FACT 7: The People and many major organizations have taken my Pioneering work very seriously. As of this date, I have sold worldwide approximately 8,000 copies of my book. Some of the organizations who purchased my book are listed on page 22. To appreciate the "Truth" of this Report, I recommend that the reader review these names before proceeding to FACT 8.

FACT 8: Why do you think these numerous organizations across the nation and the world have purchased my book, THE ENERGY MACHINE OF JOSEPH NEWMAN? Keep in mind that there are many major organizations that purchased my book under names other than their own or gained access to my book without my knowledge, e.g., through bookstores. From experience, I know this to be a fact. Observe that there is a constant interest to this very date.

NOW FOR A MAJOR POINT OF THIS REPORT: Since the time of the broad dissemination of my work, others have filed broad patent applications which infringe on my "Pioneering" Technology under the guise of "Superconductivity."

FACT 9: On February 16, 1987 a news feature was broadcast by KHOU-TV, Channel 11 in Houston, Texas concerning Dr. Paul C.W. Chu of the University of Houston and reported by Space and Science Reporter, John Gitter, who narrated over much of the film and stated in part:

*"It [superconductivity results performed by Chu at the University of Houston] changes our understanding of the basic makeup of matter ... and because of all that and more, University officials expect the next big battle, (the first being recognition of the achievement), the next big battle will be ownership of an idea **WORTH BILLIONS.**" [Emphasis added.]*

On the same Houston broadcast, Richard Van Horn, President of the University of Houston stated: "*It's obvious there is a broad-scale commercial application for this kind of an invention.*"

FACT 10: Dr. Paul Chu of the University of Houston rushed to file a Patent in January 1987, and as quoted from *DISCOVERY NEWSDAY*, Part 3, claimed before Congress that his work is "Pioneering."

FACT 11: **The facts will prove that Chu's "Pioneering" claim in FACT 10 above is a Lie!** It is also likely that the top level management of the University of Houston is greatly influenced by oil interests.

The following is quoted from *ENGINEERING NEWS*, May 25, 1987:

*"... Chu studied the reaction of oxides **under high pressure to encourage superconductivity.** Last winter, he reported that **under high pressure** (a few hundred thousand pounds psi) a compound made up of lanthanum, barium, copper, and oxygen superconducts at 40.2K. His experiments reached even higher temperature ranges. Then, after hitting a limit of 60K **with pressure techniques.** Chu varied the compounds."*

To understand the significance of this Report, it is important to note the dates of Chu's superconductivity/pressure activities: **JANUARY AND FEBRUARY, 1987.**

FACT 12: In December, 1985 I published the 2nd Edition of "THE ENERGY MACHINE OF JOSEPH NEWMAN." Several months prior to December, 1985, **Dr. Paul C.W. Chu of the University of Houston called me at my home and asked me to be more explicit concerning operational methods of achieving superconductivity. I told Chu that there are many ways to cause the effect of superconductivity such as high pressure, electrical and/or magnetic input, heat, and even slight changes of materials.** I told Chu to go back and "Master" what I teach in my book and not to simply read it! I especially recommended Chapter 11 and Chapter 12 of the 1st Edition of my book where I presented scientific proof that materials and their atoms as well as crystals react to force, pressure, electrical or magnetic input and that slight changes in material would cause noticeable differences even to the point of producing new materials.

★ For further proof of the "Truth" of the facts presented in this Report, see page 22 for the extensive list of organizations, universities and corporations that have purchased my book.

FACT 13: Anyone who has any reasonable thinking facilities can verify that I teach what I advised Dr. Chu — simply Master Chapters 11 and 12 (as published in 1984 in the 1st Edition of my book). Examine Figures 25-H, 25-J, 25-L, 25-M, 25-N, and 25-P on pages 74, 75, and 76.

In section 25-O on page 76 I conclude:

“All of the above processes — which involve producing double refraction in a normally isotropic medium via the application of mechanical deforming forces, magnetic fields, and electrical fields have a basic similarity: in each case, physical (mechanical) strains are produced within the medium which accordingly becomes anisotropic.”

[Definition of anisotropic as quoted from Webster’s dictionary: “exhibiting properties with different values when measured along axes in different directions <an~crystal>: assuming different positions in response to external stimuli.]

Continuing from page 76 —

*“Consequently, there is a definite, scientific pattern which emerges in the above observations: **THE GYROSCOPIC COMPOSITION OF MATTER REACTS TO A PROPER FORCE.** [Even in their attempt to steal my work, Dr. Paul Chu and others still fail to comprehend the total significance of this fact!]*

- (1) Observe that in all cases a force is applied which causes the electromagnetic composition of the material to react.
- (2) Observe that in all cases the presence of electromagnetic energy is obvious.
- (3) Therefore, in all cases the reactions were due to the material composition (electromagnetic energy) being affected by the mechanical action of such electromagnetic energy (consisting of gyroscopic particles). Such reactions demonstrate the **“action/reaction effect” created by the gyroscopic spin or plane which constitutes the basic mechanical structure of all matter!**”

All of Chapter 11 and those disclosures prior to Chapter 11 of my book cause me to conclude on page 79, Section 25-T:

*“Question: Have you Mastered what was taught in Section 25 above? If you have, then you must now realize the critical importance of understanding the mechanical, gyroscopic-action-entity comprising the atoms of all materials. Many such materials will be used in energy machines designed for 100% (conversion) efficient utilization of Einstein’s equation of $E = MC^2$. **SUCH AN UNDERSTANDING WILL ALSO PERMIT THE CREATION OF NEW MATERIALS WITH VARYING ELECTROMAGNETIC CHARACTERISTICS.**”*

*“By studying what I have written, you have glimpsed the Mechanical Essence of Quantum Mechanics: the Gyroscopic-Action-Particle. This “gyroscopic-action-particle” is the basic building block of all matter and is the Mechanical Essence of $E = MC^2$. **The behavior of the gyroscopic particle can still be mechanically understood and operationally predicted in accordance with Newtonian Mechanics.**”*

FACT 14: When Dr. Chu had called me at my home in the Fall of 1985 (see FACT 12 above), it was obvious that he had obtained a copy of my book, “THE ENERGY MACHINE OF JOSEPH NEWMAN,” or why else would he have asked the question that he did? Actually, Dr. Chu told me explicitly that he had obtained a copy of my book.

On page 53 — which is prior to Chapters 11 and 12 of my book, “THE ENERGY MACHINE OF JOSEPH NEWMAN,” — I specifically discuss “Superconductivity” and I state:

“The most efficient conducting system design is one in which the greatest number of atoms within a coil are aligned by the given current (gyroscopic particle) input. It is therefore obvious that a properly designed superconducting system would produce even greater results.”

Please bear in mind that this information was published in 1984!

In my book, I explained that Superconductivity is simply a result of atom alignment and I even emphasized in large print on page 53: “... I stress that it is essential that one design and establish the correct geometric configuration.”

FACT 15: The facts prove that in 1984, my book, “THE ENERGY MACHINE OF JOSEPH NEWMAN,” was published and that it disclosed:

- (A) **That matter reacts to any Force, from its gyroscopic basic entity and to its atoms and crystals, including Superconductivity materials.**
- (B) **That new materials with varying electromagnetic characteristics could be created by understanding what I teach.**
- (C) **That Matter could be converted into Energy in accordance with Einstein’s equation of $E = MC^2$ on a 100% conversion process by what I teach.**

★ For further proof of the “Truth” of the facts presented in this Report, see page 22 for the extensive list of organizations, universities and corporations that have purchased my book.

(D) These Pioneering teachings which I published in 1984 are now falsely claimed by Dr. Paul C.W. Chu of the University of Houston.

FACT 16: For further proof that Dr. Chu of the University of Houston called me as described in FACT 12 above, see pages 289 through 291 of my book, "THE ENERGY MACHINE OF JOSEPH NEWMAN," which presented even more detail on Superconductivity. These pages were published in the 2nd Edition of my book, "THE ENERGY MACHINE OF JOSEPH NEWMAN" in December 1985.

The following is quoted from the top of page 289 concerning the subject of superconductivity:

"It has been recommended that I present an extended discussion concerning superconducting materials and cryogenic magnets."

Question: Who do you think would have asked me such a question — an average electrical engineer who may know very little about superconductivity or someone who was specifically working towards achieving superconductivity at warmer temperatures?

FACT 17: To further prove the statements in FACT 15 that my teachings applied to Superconductivity, refer again to page 290 of my book:

"That if you can cause the atoms of a material to align and unalign at your will, $E = MC^2$ will be released at your will. But how is this done? (Simple — by varying Mechanical means of causing atom alignment: applying or not applying pressure, force, or heat, or electrical or magnetic input..."

Refer back to FACTS 13 and 14 and see how they match. The above quote (an excerpt from page 289 of my book) is from an Affidavit I sent to the U.S. Patent Office in 1982, whereby it should be obvious that I was teaching FACTS 13 and 14 as they applied to Superconductivity. This was FIVE YEARS before Chu's press conference in Houston, Texas, where he attempted to make claims to a technology that was not innovated by him! Also, refer again to the last two paragraphs of FACT 13 that even "**New Materials**" with varying electromagnetic characteristics would be created — a statement anticipating and predicting the oxides that would be later developed for superconductivity purposes.

FACT 18: Quoting from USA TODAY, July 29, 1987, Section 2-B:

"In February [of 1987], scientist Paul Chu of the University of Houston, working with colleagues at the UNIVERSITY OF ALABAMA AT HUNTSVILLE, stunned the world with magical new ceramics that become superconductive at minus 283 degrees."

From the facts it is obvious that Dr. Chu also worked with chemists in this group at the University of Alabama in Huntsville. Now examine the names of organizations that I have specifically listed on page 22 as having purchased a copy of my book. Observe that the **Department of Chemistry at Oakwood College in Huntsville, Alabama ordered the 2nd Edition of my book, "THE ENERGY MACHINE OF JOSEPH NEWMAN,"** in February 1986. This second Edition included the written discussion on page 289 about the question Dr. Chu had asked me by telephone several months earlier in the Fall of 1985 at a time that was prior to the publication of the 2nd Edition.

When I recently called the Chemistry Department at Oakwood College in Huntsville, Alabama, **I was informed that some of their Chemistry professors also taught at the UNIVERSITY OF ALABAMA IN HUNTSVILLE.** This clearly demonstrates additional proof that Chu and his colleagues had access to my "Pioneering" work.

Now return to the name of ORGANIZATIONS/UNIVERSITIES/CORPORATIONS which I have listed on page 22. Observe that in September, 1986, the Redstone Arsenal Scientific Library of the U.S. MISSILE COMMAND at Huntsville, Alabama, purchased two of my books entitled "THE ENERGY MACHINE OF JOSEPH NEWMAN."

Upon further investigation I discovered that it is common practice for the faculty of the University of Alabama at Huntsville to utilize the U.S. MISSILE COMMAND Scientific Library and vice versa.

To paraphrase from the August 10, 1987 issue of METALWORKING NEWS, page 9, entitled "*Atom Movement May Bring Superconductivity Gains*":

The University of Alabama in Huntsville, Alabama, is receiving funding from the Strategic Defense Initiative (S.D.I.) Office — known as the "Star Wars" program — for classified work **and is directing a consortium of a number of large corporate entities such as Boeing to perform classified work.** [End of paraphrasing.]

Return to the beginning of FACT 18: Quoting from USA TODAY, "... Paul Chu of the University of Houston, working with colleagues at the University of Alabama at Huntsville..."

Question: Whom do you think contacted whom in initiating this project? As quoted from THE NEW YORK TIMES, March 10, 1987, page C-6 concerning "Superconductivity:" "The leader of the group at University of Alabama was a former student of Chu, Mau-Kuen Wu, of the University of Alabama at Huntsville." Therefore, given any similar task as quoted from the METALWORKING NEWS article described above, Wu would naturally turn to Chu.

★ For further proof of the "Truth" of the facts presented in this Report, see page 22 for the extensive list of organizations, universities and corporations that have purchased my book.

The "Star Wars" (S.D.I.) Program was initiated by the stupidity of Ronald Reagan and his cohorts in March of 1983. [For time comparison of events, see the Chronology of Events Graph pictured on the next page. Then compare this chronology to the summary on page 1 which demonstrates Reagan's negative and deceptive actions at the end of 1983 and at the beginning of 1984 concerning my pioneering work.]

There is no defense system which cannot be beaten! The human "mind" is capable of achieving any desired results. The history of War verifies that if a system or enemy cannot be beaten easily from without, then it will revert to beating the system of the enemy from within. Example: The Trojan Horse of Homeric fame. I myself attest to this fact. For years, the motto on my business card has been, "If it can't be done, it interests me!"

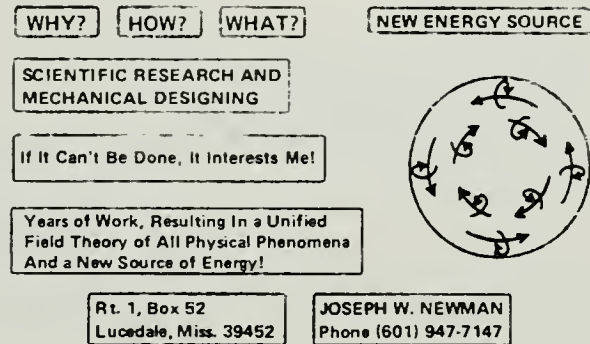

Peace will only be achieved by Wisdom and Caring, not through Stupidity and Noncaring or only partially caring.

I urge any sharp-minded member of the press who wishes to cover the hottest story of the century to investigate (via the rights protected by "The Freedom of Information Act") the government files for all correspondence concerning Joseph Newman and/or his Energy Invention from all government agencies, e.g., the White House, National Bureau of Standards, Department of Energy, Patent Office, National Science Foundation, Department of Commerce, Strategic Defense Initiative (S.D.I.), Universities or corporate entities receiving taxpayers money associated with S.D.I., Department of Army, Navy, Air Force, NASA, War Department, CIA, FBI, telephone tap requests on my telephone, or any other source that you may suspect.

However, in an effort which is euphemistically termed a "revision" of the Freedom of Information Act, Ronald Reagan is vigorously pushing for legislation at this very moment to make sure that you do not have the right to investigate the government files concerning "Superconductivity!" The "excuse" used by Reagan is that foreigners should be denied Freedom of Information access concerning "Superconductivity." But what applies to foreigners can also apply to U.S. citizens and members of the press. [For a discussion of this attempt to violate the Freedom of Information Act see an article entitled "President Reagan Outlines 11-Point Plan for Commercializing Superconductivity" from *THE CHRONICLE OF HIGHER EDUCATION*, Vol. XXXIII, No. 47, August 5, 1987, page 4.]

Ronald Reagan claims that the National Science Foundation and NASA provided the funds to Chu for his superconductivity tests.

Of course, Ronald Reagan has claimed several things in the past that were simply not true.

But even if Reagan's claim was true, I would consider it only a further deceit to remove suspicion from the real purpose of "Star Wars" (S.D.I.). However, the attempt still fails because my book, "THE ENERGY MACHINE OF JOSEPH NEWMAN," totally documents that both NASA and the National Science Foundation have been eminently aware of my **Pioneering** work in the 1970s and even as early as the 1960s. [To document this statement, see pages 113, 115, 122, 123, 124, 182, 185, 197, 198, 199, 203, 204, 205, 206, 209, 210, 211, and 212 of my book, "THE ENERGY MACHINE OF JOSEPH NEWMAN."]

Therefore, if NASA and the National Science Foundation did fund Dr. Chu, then they certainly informed him of my work considering the extensive national publicity I was receiving as well as their past involvement in the same issue.

The facts above clearly show a direct link to "Star Wars" (S.D.I.).

While Ronald Reagan and his cohorts are not brilliant, the Individuals who pull Reagan's and his cohorts' strings are anything but stupid. They know that the "Star Wars" extravaganza will make them even more fabulously wealthy and serve to multiply their power and influence in a never-ending, corrupt cycle. The American taxpayer pays the price and the people of the world are denied access to an energy source which would end pollution and world hunger.

FACT 19: Let's examine again the chronological history of Superconductivity and see how its history matches the facts. The recent advancements in Superconductivity result from my "Pioneering" 22 years of dedicated work: [Because of the importance of this graph, I am repeating it in this Report.]

★ For further proof of the "Truth" of the facts presented in this Report, see page 22 for the extensive list of organizations, universities and corporations that have purchased my book.

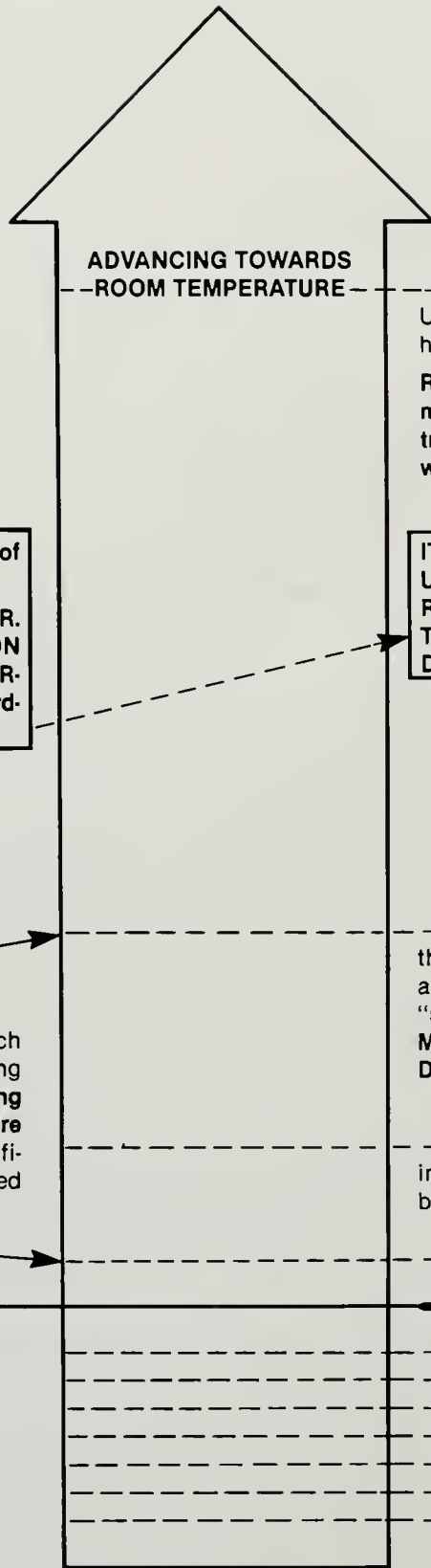

ADVANCING TOWARDS
ROOM TEMPERATURE

--- 28°F --- **March 1987** --- Researchers at the University of California (Berkeley Lab) report hints of temperature this high

Researchers at the Berkeley Lab had received my book and had spoken with a WWL-TV electronics engineer in New Orleans who had worked with me in Lucedale, Mississippi

It took 75 years to raise the temperature of superconductivity by 62 degrees.

IT TOOK ONLY TWO MONTHS FOR DR. CHU OF THE UNIVERSITY OF HOUSTON TO RAISE THE TEMPERATURE OF SUPERCONDUCTIVITY A "STUNNING" (according to the media) 106 DEGREES.

IT TOOK ONLY ONE MONTH LATER FOR UNIVERSITY OF CALIFORNIA (Berkeley Lab) RESEARCHERS TO RAISE SUPERCONDUCTING TEMPERATURE AN ADDITIONAL 256 DEGREES.

--- 284°F --- **February 1987** --- Dr. Paul Chu at the University of Houston and his colleagues at the University of Alabama at Huntsville "stun" the world. **THESE INDIVIDUALS HAD MY BOOK AND I HAD PERSONALLY ADVISED DR. CHU HOW TO PROCEED.**

Many other superconductivity research scientists around the world were testing the new French oxides, but Chu — by using **PRESSURE on the new oxides that were discovered by others** — obtained significant, immediate results and then altered oxides to achieve ever better results

--- 390°F --- December, 1986 --- IBM scientists in Switzerland utilize new oxides discovered by French chemist

PUBLISHED MY BOOK, "THE ENERGY MACHINE OF JOSEPH NEWMAN"

--- 406°F --- January, 1986

DECEMBER, 1984

- 419°F (1973)
- 422°F (1969)
- 427°F (1960)
- 429°F (1953)
- 433°F (1941)
- 442°F (1933)
- 452°F (1911)

★ For further proof of the "Truth" of the facts presented in this Report, see page 22 for the extensive list of organizations, universities and corporations that have purchased my book.

FACT 20: Let's examine comments from the conventional scientific community concerning the recent, significant advancement of "Superconductivity —

- (A) Quoting from *ENGINEERING NEWS*, May 25, 1987, page 25: "*It is clear that we are dealing with a previously unknown physical phenomenon,*" says Roy Weinstein, Dean of natural sciences at Houston."
- (B) Quoting from *THE NEW YORK TIMES*, Tuesday, March 10, 1987, Section C-6: "'It's already an amazing discovery,' said Alex Zettl of the University of California at Berkeley. 'A year ago it was totally out of the question. Every theorist would have laughed. It was just science fiction ... it's one of the greatest achievements of theoretical physics,' said Dr. Zettl, 'but right now the experimentalists are way ahead of the theory.'"
- (C) Quoting from *USA TODAY*, July 29, 1987 in an article entitled "Superconductivity Race:" "'Experiments work over and over again, but we still have no complete understanding of why these materials superconduct,' said Erich Bloch, Director of the National Science Foundation."

FACT 21: I now refer the reader to my teachings about Superconductivity from page 290 of my book, "THE ENERGY MACHINE OF JOSEPH NEWMAN" — teachings which were sent to the U.S. Patent Office in April, 1982 and published in the 2nd Edition of my book (December 1985) as a result of the question asked of me by Dr. C.W. Chu (see FACT 12) in the Fall of 1985:

"The point is — while these cryogenic results would not be obvious to an examiner not skilled in cryogenics, these results would be obvious to those who were skilled in cryogenics and mastered the applicant's Specification! Applicant is sure that there are already other materials and experiments now existing in exotic labs that he does not know about, but which will be obvious to others so skilled; that those materials and experiments will be easily applicable to the vastness of what applicant has so earnestly taught and disclosed, once applicant's teachings and disclosures are mastered by those so skilled.

"Applicant has taught a diligent, wide, Mechanical, and Technical Process of releasing energy from Mass or a Magnetic Field. Applicant has even taught the incorrectness of prior teaching: from the teachings concerning Work, Force and Power, to the Three Laws of Thermodynamics, to the teachings that a magnetic field represents only potential work and no kinetic work, to the 'whys' of conventional electrical production, and to the 'whys' of gravity and the motions of planets and stars. Applicant has mechanically explained matter, inertia, heat, magnetic fields, electricity, and much more — all of which has been always directed toward a single goal of releasing a new source of energy from Matter by a Technical Process which he could teach to others and for the well-being of all generations to come.

"Applicant has indeed taught a diligent, wide, Mechanical, and Technical Process of releasing energy from a Mass or a Magnetic Field. This has been earnestly taught in the Specification and its important scientific document of the patent application of applicant's extremely pioneering invention.

"The sincere effort of applicant is in the file wrapper for all of posterity to see and to judge. Therefore, in accordance with Supreme Court's prior actions and the intent of Congress, and as an assured incentive for future inventors, applicant feels he is most certainly entitled to very broad coverage and interpretation of the genius and labors of his many years of diligent work, which will so greatly benefit his fellow human beings."

FACT 22: Quoting from *THE NEW YORK TIMES*, Tuesday, March 10, 1987 concerning superconductivity:

"The patent implications alone may take years to sort out. Not only have various researchers applied for patents on each new material, but IBM and Bell Laboratories are both trying to patent the entire class." [However, the initial superconducting oxide was discovered by French scientists.]

An IBM engineer purchased my book in June, 1985, and also personally called and spoke with me several times while asking technical questions about my work.

Further factual proof of my pioneering technology is presented in *NEW SCIENTIST*, July 30, 1987 from an article entitled "*Do It Yourself Superconductors.*" This article provides directions offered by IBM scientists on how students can build superconductors. Under the subtitle "'Now press on ...'" the directions state:

"Obtaining or making the [superconducting] pellet press probably presents the greatest challenge in the project ..."

"... a pressure of 15,000 to 18,000 pounds for a ½" diameter pellet will more than do the job."

When Chu called me in the Fall of 1985, I specifically recommended that **pressure** should be employed in achieving superconducting materials.

★ For further proof of the "Truth" of the facts presented in this Report, see page 22 for the extensive list of organizations, universities and corporations that have purchased my book.

Bell South, an associate of BELL LABORATORIES, Atlanta, Georgia, had four engineers come to my home and talk in great detail about my work. They filmed the entire meeting in February, 1984 and then had me travel to the Atlanta Office on March 16, 1984.

FACT 23: Again, examine the wide dissemination of my **Pioneering** Technology by reviewing the numerous organizations listed on pages 22-25, that have purchased my book, "THE ENERGY MACHINE OF JOSEPH NEWMAN." Approximately 8,000 copies have been sold worldwide. Question: Why?

FACT 24: **None of these people including Chu are entitled to any broad patent coverage. What they are entitled to is a patent covering the particular material(s) that they discover and demonstrate.**

It is I who have taught the broad scope (Pioneering) methods which caused the "stunning" superconductivity results to occur — teachings which were published in December 1984 and December 1985. Such teachings were originally presented and published in my 1979 Patent Application and in my Disclosure to the Patent Office in 1982. Such teachings were YEARS before Chu's claims in January 1987!

Joseph Newman disclosed how to achieve the breakthrough in Superconductivity in his book, "THE ENERGY MACHINE OF JOSEPH NEWMAN" and in patents applied for and some granted. [As of this date, Spain, South Africa, India, and Argentina have approved patents for Joseph Newman.]

PATENT LAW 102:

"CONDITIONS FOR PATENTABILITY: NOVELTY AND LOSS OF RIGHT TO PATENT" states:

"A person shall be entitled to a patent unless —

- (a) the invention was known or used by others in this country or patented or described in a printed publication in this or a foreign country, before the invention thereof by the applicant for patent, or**
- (f) he did not himself invent the subject matter sought to be patented."**

The facts prove that I have extensively and publicly disclosed the Pioneering aspects of Superconductivity **prior to** Dr. Paul C.W. Chu and others.

I would have no logical motive to claim — unless it were true — that Dr. Paul Chu had called me in the Fall of 1985 as I have state above. Both Patent Law and scientific history, as well as tradition and protocol give credit to the individual who **first** makes a discovery public.

My blatant honesty is well known by People who have known me and dealt with me over long periods of time. This fact is exemplified by letters from such individuals on pages 171, 172, 173, 174, 176, and 179 of my book. This fact is even further demonstrated by my life's work as disclosed worldwide in my book, "THE ENERGY MACHINE OF JOSEPH NEWMAN."

On the other hand, for me to have knowledge of the revealing facts presented in this Report — facts that are of tremendous importance to the People — and then fail to disclose these facts would show me to be weak and dishonest. My life's work proves that I am neither.

FACT 25: **All of the above facts resoundingly echo the findings of the Special Master (someone skilled in the art) chosen by Federal Judge Thomas Penfield Jackson to evaluate my energy machine technology. This same Special Master was nominated as Special Master by the U.S. Patent Office and was a former Commissioner of Patents.**

The September, 1984 Report of the Special Master to the Court hearing my suit against the Patent Office for a pioneering patent stated:

"Evidence before the Patent and Trademark Office and this court is overwhelming that Newman has built and tested a prototype of his invention in which the output energy exceeds the external input energy; there is no contradictory factual evidence."

★ For further proof of the "Truth" of the facts presented in this Report, see page 22 for the extensive list of organizations, universities and corporations that have purchased my book.

Saturday, April 12, 1986 The Times-Picayune/The States Item

METRO NEWS

Energy Machine wows crowd at Superdome

By MICHAEL PERLSTEIN
Staff writer

Mississippi inventor Joseph Newman brought his Energy Machine to the Superdome Friday to convince the public of something he's been trying to get the U.S. Patent Office to believe for 20 years: that the device can produce unlimited amounts of energy for free.

More than 1,500 people paid \$1 admission to see the machine Friday, the first day of a week of demonstrations.

They came from as near as Houma and as far as Switzerland and South Africa, and many said they were convinced Newman's invention will work.

But the U.S. Trademark and Patent Office has not been nearly as sympathetic. Officials have repeatedly told Newman that his claims are impossible, and they have refused his request for a patent.

However, physicists and engineers who once scoffed at Newman's ambitious ideas spoke Friday in his behalf.

Newman claims the machine swallows energy from any power source and generates up to 14 times as much, without polluting.

The Lucedale, Miss., inventor claims he has discovered the principle of magnetic energy, a puzzle that still baffles physicists, and uses it to create electricity.

"I challenge any Ph.D. to get up on the stage and debate with me and prove me wrong," he said.

There were no takers, and many in the audience said they believed him.

Victor Melillo traveled from Cherry Hill, N.J., to see the machine.

"This machine is the greatest thing ever to happen to mankind," Melillo said. "What the patent office is putting this man through is a travesty."

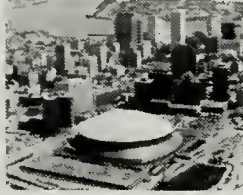

Cindy Dickinson of Atlanta admitted she didn't really understand Newman's ideas but thinks "it's crucial to get this to the people. If this machine works the people deserve to know what the government is keeping from them."

Stanley Higgins of New Orleans said, "If what he says is true, this is the biggest thing that's ever happened. How can you miss that when you live only 20 minutes away?"

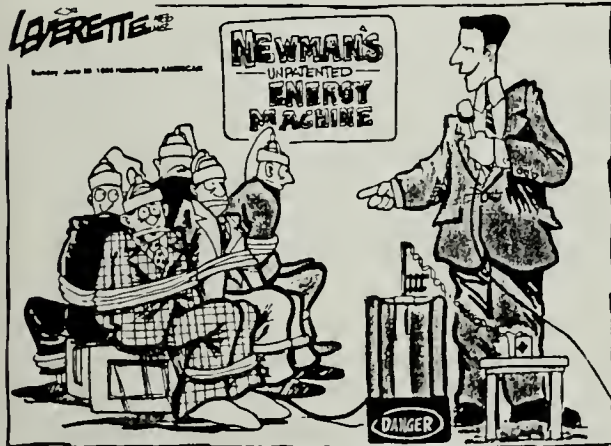
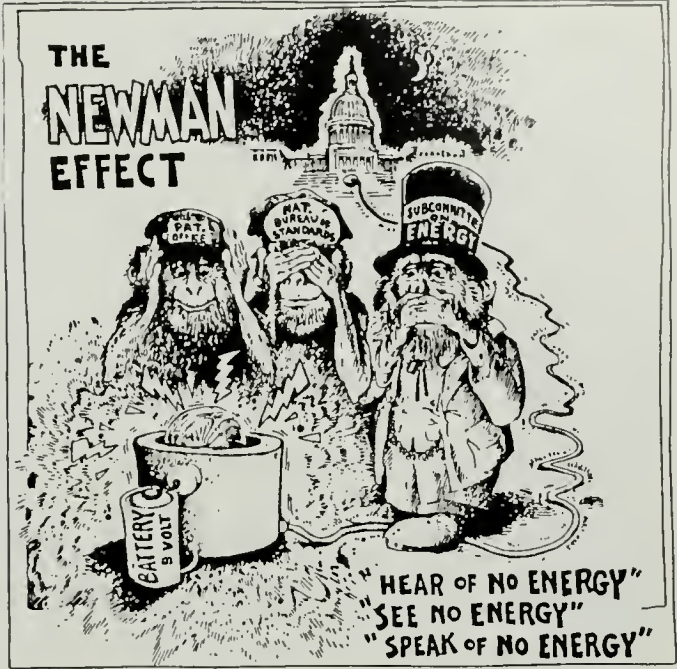

"FOR A FINAL DEMONSTRATION I WOULD LIKE TO ELECTROCUTE THE FELLAS FROM THE PATENT OFFICE BY USING THE POWER OF A 'D' CELL BATTERY."

THE PUBLIC PULSE: LETTERS

Newman deserves a patent

Never having met, talked with nor had financial dealings with Mr. Joe Newman (*Press Register* Aug. 23), I read his book, *The Energy Machine*. After 30 years in the electrical profession I felt eminently qualified to debunk his claim to a device that generates more energy than it consumes. In the second chapter, I sat up in bed and shouted "He's got it!"

More amazing is his theory on gravity that will, I believe, lead to weightless objects. Don't snicker, scientific community; read it and refute if you can. Mr. Newman is no shade-tree tinkerer. Dozens of leading scientists are len-

Mobile PRESS REGISTER

ding support. Dr. Hastings, principal physicist, Sperry-Unival Corp., said, "The future of the human race may be dramatically uplifted by the large scale development of this invention."

Basic electrical knowledge is necessary to understand his book and a toy gyro would be helpful. Mr. Newman deserves a patent. We should contact our senators and representatives in his behalf; no doubt the energy lobby is working overtime.

PATRICK MCLAIN
128 Confederate Drive
Spanish Fort.

FACT 27: Under the guise of Superconductivity, there are those who deceptively say that they have a New Source of Energy and that it is different from my **Pioneering Technology**.

Their claim is totally absurd since Superconductivity simply represents a greater atom alignment of the material or materials involved.

A conventional copper wire is a "Superconductor" when compared to a conventional resistor wire!

In and of itself, Superconductivity does not represent a "New Source of Energy." In conjunction with the "New Source of Energy" that I described in my Pioneering Patent Application of 1979, superconductivity assumes greater significance.

FACT 28: Since 1979, the U.S. government has consistently, deliberately, and premeditatedly fought the application of my pioneering invention. Other countries, however, have issued or are in the process of issuing this patent: Spain, South Africa, India, and Argentina. I have consistently charged the U.S. Patent Office, Federal Judge Thomas Penfield Jackson (who is involved in the patent application suit), and all the way up to President Reagan with deliberately violating both Federal and Patent Law. On many occasions I have said that the Injustice against me and the Human Race would make Watergate appear "as a molehill to a mountain."

★ For further proof of the "Truth" of the facts presented in this Report, see page 22 for the extensive list of organizations, universities and corporations that have purchased my book.

FACT 29: This injustice now becomes even more outrageous. By fighting me, the U.S. government has cost me over \$1,000,000.00 in my efforts to bring this Technology forward for the benefit of humanity.

Compare such government opposition with the following news item quoted from the Section B cover story in *U.S.A. TODAY*, July 29, 1987 entitled *USA rallies champs of supertech*’:

“WASHINGTON — Scientists are assembled here, 1,100 strong, as high-tech champions... These superconductivity experts, handpicked for a historic two-day federal conference...”

[Handpicked by whom? Moreover, the individual who for over 22 years has truthfully championed the **Pioneering** Technology that caused the “stunning” superconductivity results to occur was excluded from this Washington meeting.]

Question: Who do you think is most competent to push this Technology for humanity — individuals who had done nothing before my work and then clamor to steal it and vigorously use it for purposes of war, or the individual who devoted his life to its fulfillment and the achievement of World Peace?

Question: Why do you think that they have so deliberately acted to thwart me and attempted to steal my achievement? Because they know the speed with which I would push forward this Technology for humanity and remove it from their control.

The *USA TODAY* article also stated that other countries such as Japan, etc., are possibly moving ahead of us since their governments are already putting money into the advancement of superconductivity. Interestingly enough, on two occasions people from Japan have visited my home, taped my work, and my work has been printed in major papers in Tokyo and other places in Japan. My books are sold in Japan and the Chubu University has a copy of my book.

Question: Rather than deliberately fight me in the advancement of this Pioneering Technology for the last eight years, what do you think would have happened if the U.S. Government had been behind me and had guided competent scientists towards the full development of my Pioneering Technology?

The USA TODAY article stated that President Reagan made an unprecedented appearance at the conference and that Reagan stated, “We haven’t even begun to dream the possibilities.” The article quotes Reagan as stating that he will offer a legislative initiative to ease anti-trust laws, strengthen patent laws, and protect intellectual property. The article also states that the Government will put forth millions of dollars to push forward the advancement of superconductivity. At the same time the U.S. Government keeps me tied up in a Court struggle that costs me and the American taxpayers money and time!

Now Reagan wishes to appear to the people that it is **he** who is pushing for this **Pioneering** Technology from the government’s standpoint. **The facts show that Reagan and his cohorts are talking out of both sides of their mouths and they should be regarded as liars and hypocrites!** They are also fools who echo the hollow words of historical “war fools.”

FACT 30: In the early 1980s, Reagan appointed Donald Quigg as the Commissioner of Patents. [Quigg was formerly a top executive with a major oil company for 38 years.] Donald Quigg has consistently lied when asked about my **Pioneering** Technology and continues to lie and fight its patentability to this very day.

In the early 1980s, Reagan appointed Thomas Penfield Jackson as a Federal District Judge in Washington, D.C. Jackson was knee-deep in the Watergate scandal as the attorney for John Mitchell and CREEP (Committee to Re-Elect the President). Jackson has consistently been a pawn to Reagan’s instruction. Even the newsmedia had to file suit against Jackson concerning the trial of one of Reagan’s closest friends — Michael Deaver.

Thomas Penfield Jackson has consistently violated Patent and Federal Law concerning my **Pioneering** Technology and even to this day remains dormant by failing to issue a ruling on the trial concerning my suit against the Patent Office. The trial ended in December, 1986. Judicial action was expected by March, 1987. The months continue to add up and Jackson fails to act.

During the December, 1986 trial my very competent attorney, John Flannery, of Washington, D.C. made a fool of the U.S. Patent Office and the National Bureau of Standards. **I intentionally did not attend the trial — my absence was to accent the absence of Justice in the Court of Thomas Penfield Jackson. And this trial represented a trial of my life’s work!**

FACT 31: QUIGG — JACKSON — REAGAN: These are the same corrupt individuals that will cause me to seek wasted and costly motions of filing an interference suit with the U.S. Patent Office concerning those individuals/entities/organizations which are claiming more than that to which they are entitled and claims which infringe upon my **Pioneering** Technology under the guise of “Superconductivity.” Had the U.S. Patent Office issued my Patent years ago, then such acrimony would be totally unnecessary.

FACT 32: The facts show that Reagan — as a result of having his strings pulled by others representing other interests — has succeeded in delaying the **Pioneering Patenting** of my revolutionary technology while at the same time pushing forward Superconductivity behind the scenes.

★ For further proof of the “Truth” of the facts presented in this Report, see page 22 for the extensive list of organizations, universities and corporations that have purchased my book.

FACT 33: History will guarantee the verification of this attempted or completed greatest Fraud and Theft that may be directly attributed to Ronald Reagan. That is — if the world exists to have a history (?)

My work is known throughout the world and has been published across the world

The press release is being sent to several thousand members of the press, to every Senator and Congressman, to over 1000 Colleges and Universities, and to approximately 8,000 individuals or organizations that have purchased my book "THE ENERGY MACHINE OF JOSEPH NEWMAN"

FACT 34: What is ironic is that my enemies — Greed, Power, Recognition, etc — do not even understand that because I care so much about Humanity, that if I had to do everything all over again under the same tremendously adverse conditions, e.g., fighting the U.S. Corrupt Government, I would do it all over again and again and again.

In their eagerness to steal my work and slow the advancement of my life's work for Humanity, they ironically serve to push forward the magnitude of my Pioneering Technology and benefit Humanity. From the beginning 22 years ago, I have been keenly aware that this Technology is of crucial importance to the benefit, survival, and advancement of Humanity.

FACT 35: Justice is not only for Joseph Newman, but is for the further advancement of Science, the Human Race, and the children yet unborn who will live to know the results of whether there is justice or injustice to those who devote their lives as caring individuals for the benefit of others. The scientific community and all people who care about science and human advancement should vigorously speak out about this Injustice. Not to do so condemns the advancement of the Human Race because this Truth will live on!

This is the Bicentennial Year of our Constitution and this Injustice is a Mockery to its very essence.

As I have said before, I say again: Ronald Reagan, Donald Quigg, and Thomas Penfield Jackson should be IMPEACHED. If my words of "impeachment" seem strong in 1987, I am fully convinced that they will be justified in 2087! Not to call for impeachment guarantees that others will be encouraged in the future to commit even greater Injustice, and it is you the "People" and the ones you love who will suffer the consequences.

While I would prefer to receive justice for my years of work, I am prepared to be the *last* to receive injustice if I can ensure by my actions that no innovator in the future will have the fruits of his or her labors plundered by unscrupulous persons. Such plunder robs the innovator of incentive and thereby cripples the advancement of Humanity.

FACT 36: Even now it is so obvious to me that many individuals who claim to be in the forefront of the superconductivity discovery still folly around with it. They still insist upon applying high current through the superconductor which inhibits the superconductor's characteristics exactly as I vigorously teach throughout my book. Anytime one applies too much current in excess of the threshold point of the material's atoms, heat is produced, the atoms become unaligned and the strength of the magnetic field is reduced. I have consistently taught that the magnetic field does *not* come from the current, but comes from the atoms comprising the conductor. That is exactly what is demonstrated. I consider anyone who claims to be a scientist is actually a fool if, after looking at these facts and my book, such a person does not recognize that I speak the truth on this subject.

"Superconductivity" applied to my Pioneering teachings would work right now. Fine wire would simply be made very long with numerous turns and small current to make the magnetic field great with little or no heat. As a result, the superconductivity will last.

FACT 37: To further explain the rightness of my teachings and for those who wish to think and make advancements: do not only heat the material and apply pressure but also apply heat and/or electrical and/or magnetic field for a given time and then apply pressure while in the electrical and/or magnetic environment and then raise the heat and/or electrical and/or magnetic environment for a given period of time and apply additional pressure. By conducting many different tests with many different materials, one will find, as I teach, that small changes in one or more parts will cause drastic changes in the finished material to allow the gyroscopic particles comprising its material to mechanically emanate outside the boundaries of its material which is called the magnetic "electromagnetic" field. This will result in superconductivity even at room temperature. The Scientific Method is simple: let the "facts" prove or disprove the "Theory" and the "Facts" of the mechanical methods of the tabletop breakthroughs of warmer and warmer Superconductivity prove the rightness of my Pioneering Invention and Technology. Why? Because the phenomena of Superconductivity at warmer and warmer temperatures matches exactly what I have so diligently taught. That the most efficient design of the Invention is one in which the smallest amount of current input causes the greatest amount of atom alignment of the material. This is exactly what a Superconductivity does!

Again, the Facts resoundingly echo the Special Master's Findings that my Pioneering Invention works!

FACT 38: The breadth of my technology was also recently verified by facts from the New York Times News Service as published in the *GRAND RAPIDS PRESS*, December 4, 1986.

The essence of this article states that seven world astronomers (nicknamed the Seven Samurai) have confirmed that our galaxy and all other galaxies that we could see were orbiting some unseen or undetected massive object. Of course,

* For further proof of the "Truth" of the facts presented in this Paper, see page 22 for the extensive list of organizations, universities and corporations that have purchased my book.

these facts fly in the face of "conventional wisdom." However, these observations are exactly what I have been teaching for years and are explicitly depicted on page 143 of my book, "THE ENERGY MACHINE OF JOSEPH NEWMAN."

FACT 39: To provide even more depth to my **Pioneering** Technology I gave a demonstration of how my technology can immediately and realistically be applied to space travel.

MOBILE REGISTER



Press Register photo by Jay Ferchaud

Joe Newman, Lucedale inventor, watches his mini-spaceship rise in a demonstration to an audience at the Admiral Semmes Hotel in Mobile Wednesday morning.

Newman unveils new invention

By JUNE HEYDT

Press Register Correspondent

Joseph W. Newman, the Lucedale inventor who claims he has invented an energy machine which produces more energy than it consumes, Wednesday demonstrated still another invention, this one a mini-spaceship, that he said uses this same technology.

Newman said his mini-spaceship employs his revolutionary concept of electromagnetism and the gyroscopic atoms.

"I have on numerous occasions stated that within 20 years space travel will be as commonplace as getting on a plane and flying from one city to another by the use of the pio-

neering technology that I teach," Newman said.

"Space travel can become a safe reality now — not be a potential tomb for good people by placing them in a tremendously inefficient liquid bomb, which makes the potential of a large bomb with cramped living conditions for its brave and courageous occupants," Newman said at the Admiral Semmes Hotel in Mobile.

"My technology can build space devices having dimensions of immense area thereby giving means to carry a great cargo to the extent that a miniature world environment

■ Please see Page 10, Col. 4

Newman

■ Continued From Page 1

could be transported having great beauty and practicality and giving great hope and excitement because the mysteries of the universe will be open to true explorations and inhabitation."

During the demonstration, Newman explained to the audience that he could take a coil of wire and create a magnetic field equal to the city of Mobile.

Dr. Roger Hastings, a prominent physicist, who was also at the demonstration said, "I have recently witnessed a demonstration of Newman's electromagnetic air and space vehicle demonstration prototype. It consists of an aluminized helium balloon wrapped with No. 38 gauge copper wire. The system is nominally heavier than air. When the wire coil is connected to a 200-volt battery, the balloon gradually lifts into the air. It aligns with the earth's magnetic field as it rises. If the current is cut off, the balloon immediately begins to fall. If the current direction is reversed, the balloon rotates to align with the earth's field."

Newman said, "By simply changing the magnet you can make it go anywhere you want it to go. I'm certain this device (mini-spaceship) will reach the speed of light. What you're seeing has never been done before in the history of the world."

"In five years this technology could be in space," Newman said. "I don't just blow smoke; that's a fact. I can do things the scientific community says are impossible."

Hastings explained, "Newman's design calls for creation of a magnetic field which is an average about equal to the earth's field over the volume of the balloon. This

can be achieved with minimum input power by using a large number of turns of fine wire. A vehicle which is 1,000 feet in diameter and 500 feet high would consist of 400,000 cubes and carry a payload of 4,400 tons."

These points should be noted, said Hastings: One, the total payload is proportional to vehicle volume. Two, the electromagnetic torque and lift are also proportional to volume in this design. Three, navigation is achieved by manipulating the orientation of the coils, and, four, if superconducting wires become available, the batteries will not be required.

"When the Army and Navy start producing these machines and claiming them as their own, I want you to remember where you first saw it," Newman said.

Newman, who has had an ongoing battle with the U.S. Patent Office for the last eight years, said he is still taking his inventions to the public. "The public is not stupid," he said. "They will not let things like this be kept from humanity."

"I continuously push this technology forward for the benefit of humanity. I am pushing forward now vigorously attempting to get stockbrokers to come forward and give the public a chance to put forth the funds to get this technology into full production," Newman said.

FACT 40: It is obvious that Ronald Reagan has been advised to try to use his political position to obtain patents and pioneering patents for individuals claiming my work. At the same time Reagan is giving millions and possibly billions of dollars of taxpayer's money to forward the interests of energy concerns, but at a controlled rate of advance. He uses his "associate cronies" — Federal Judge Thomas Penfield Jackson and Donald Quigg — to slow down or stifle the Pioneering Patenting of my Technology. At the same time Reagan misuses this technology and increases the possibility of war through political foolishness. As has often occurred in history of our species, those least qualified to politically lead manipulate themselves into a position of leadership.

★ For further proof of the "Truth" of the facts presented in this Report, see page 22 for the extensive list of organizations, universities and corporations that have purchased my book.

More than thirteen Congressmen have introduced bills asking Congress to issue Joseph Newman a **Pioneering** Patent because both the U.S. Patent Office and the Judicial System have failed to do Justice to my case. This effort has been delayed in Congress by others who are also advised that this Technology should not come forward. You, the People, should know that every Senator and Congressman has a copy of this material. Contact your Senator and Congressman and make this an issue with them at every opportunity where they speak or the opportunity presents itself.

Ronald Reagan has "goofed-up" and has already made superconductivity a political issue! As I have often said, there are good and evil individuals in both political parties. Those who stand in the way of goodness and its fulfillment should be damned. Those who push for the advancement of goodness and its fulfillment should be rewarded.

FACT 41: I SMILE AT MY AND THE PEOPLE'S ENEMIES — THEY HAVE BLINKED. THANK YOU FOR DOING WHAT I HAVE WAITED AND WANTED YOU TO DO. THANK YOU FOR MAKING THE ENTIRE WORLD KNOW THAT MY PIONEERING WORK IS INDEED A SOURCE OF ENERGY THAT WILL BE OF PHENOMENAL BENEFIT TO ALL HUMANITY.

NOW YOU CANNOT TURN BACK, THE "PEOPLE" WILL NOT ALLOW YOU; AND ALTHOUGH YOU HAVE DONE IT FOR THE WRONG REASON, I SMILE EVEN DURING THE FIGHT AND SAY "THANK YOU."

FACT 42: Even now I push forward vigorously in trying to enable stockbrokers to come forward and provide the general public with an opportunity to invest the funds to push this **Pioneering** Technology into full production. [We are interested in talking with underwriters who can arrange such a public offering.]

FACT 43: IF YOU ARE MOVED BY THESE FACTS —

- 1) **Call, wire, and write your Senator and Congressman. Supply this information to your local radio and television shows and let them also know of the response you receive from your U.S. Senator and Congressman.**
- 2) **Those who would be interested in an American citizen CLASS ACTION SUIT against the U.S. government — charging U.S. officials with the denial of this technology to the American people — should contact my office.**
- 3) **Urge your local newspaper to print the facts and/or your opinion about the facts, e.g., as a Letter-to-the-Editor.**
- 4) **Send copies of these facts to the heads of Engineering, Physics, Astronomy, and Chemistry Departments in local schools, colleges, and universities. Let your local newsmedia hear your views concerning faculty members who respond responsibly or irresponsibly — or if they fail to respond.**
- 5) **Contact individuals seeking the Presidency — make certain that they obtain a copy of this Report and then make sure that they publicly respond.**
- 6) **Send copies of this Report to individuals whom you feel will act on this issue.**
- 7) **Get young people involved — it is their future, their hopes, and their dreams that are at stake.**

FACT 44: I WANT YOU, THE READER, TO DECIDE WHO SHOULD BE RECEIVING THE TAXPAYER'S MONEY TO FORWARD THIS PIONEERING WORK. It is my opinion that the actions of Ronald Reagan and the people that he has directed to fight against my work will stand in History as one of the most corrupt and unjust attempts to stifle the advancement of Science and the Human Race. If you love and care about Justice and the continued advancement of the Human Race long after all of us have departed — then act and speak out for Justice concerning better than 22 years of my life for the benefit of humanity.

The "Peoples" Enemies have now made Scientists and "People" around the world aware that my pioneering technology works. Great! Let's get on with it.

I have no doubt that in the infinite span of time many worlds throughout the Universe have reached our technical stage of development only to destroy themselves in a nuclear holocaust which possibly converts their world into a type of "radioactive" star.

Scientists, "People," and leaders around the World must recognize that we all have a responsibility for one another's well-being and that we must pull together as an operational entity of one.

This Technology has the ability to bring about World Peace if our world Philosophy of Life becomes: "If I think you 'hurt,' then I hurt for you. If I think you 'smile,' then I smile with you." [From page 281 of "THE ENERGY MACHINE OF JOSEPH NEWMAN."]

Only if this becomes our Philosophy of Life will we as a species become worthy to advance into the Majestic Magnificence of the Universe.

AS APTLY SAID BY DR. ROGER HASTINGS: "If you have any kind of conscience, you can't walk away from this."

★ For further proof of the "Truth" of the facts presented in this Report, see page 22 for the extensive list of organizations, universities and corporations that have purchased my book.

FACT 45: Since the completion of the above material, certain events have occurred which compel me to announce my candidacy for the next President of the United States — as an independent TRUTH AND ACTION PARTY.

To those who wrongly and blindly claim that I do this out of malice, for power, for self-serving interest, or to simply acquire a U.S. Patent, I say emphatically:

YOU ARE TOTALLY WRONG!

To quote from page 154 of my book, "THE ENERGY MACHINE OF JOSEPH NEWMAN":

"TO ALL WHO 'MASTER' AND ARE INSPIRED BY WHAT I HAVE TAUGHT, IN THE REMAINDER OF THIS BOOK I SPEAK TO YOU:

"All of the many preceeding pages of my teachings mean absolutely nothing if the major deficiencies of world society — fear, greed, intellectual dishonesty, and lack of curiosity/intellectual aspirations — are not supplanted with superior attitudes.

"I ask you — who I seek to inspire — to please 'Master' my teachings which can correct such deficiencies. It is you who must apply what I teach to the world. With such application, I will predict the possibility of world peace as well as a productive and meaningful life for all individuals."

Only one President of the United States — Thomas Jefferson, who was the 3rd President in a sequence of 40 — has the historical reputation of having scientific and inventive talents in addition to his other important abilities.

Thomas Jefferson principally prepared our Declaration of Independence. To quote from page 108 (BOOK 2) entitled *The American Heritage Book of the Presidents*:

"Forced by events to modify soaring theory in searing practice, Jefferson left behind him a rich but paradoxical heritage. Conservatives have admired his opposition to 'energetic government,' his defense of states' rights, his opposition to the Supreme Court, his frugality with public funds, and his patrician good sense. Liberals have applauded his vigorous use of executive power, his defense of minorities, his commitment to civil liberties, and his defiance of precedent.

"It would be facile even to suggest that Jefferson was, or remains, all things to all men. It would be more accurate to say that he has emerged as America's foremost prophet and spokesman of liberty.

"For himself, Jefferson remained confident that history would corroborate that men had indeed been created equal and would continue to prefer the 'boisterous sea of liberty' to 'the calm of despotism.' And when all is said, the Jeffersonian tradition, as Boorstin has written, does remain 'our principal check on the demands of irresponsible power.'

"On July 4, 1826, the fiftieth anniversary of the Declaration of Independence, the third President of the United States died, a few hours before his old friend, John Adams. He had fought to stay alive for that day, awaking on the third of July in delirium to mutter instructions that the Virginia Committee of Safety must be warned of the British approach. Ten days before his death, Long Tom Jefferson wrote one of his last and strongest dicta of liberty. Urging that America remain to the world 'the signal of arousing men to burst [their] chains,' he said: 'The mass of mankind has not been born with saddles on their backs, nor a favored few, booted and spurred, ready to ride them legitimately, by the Grace of God.'"

Those who wish to know who I am and who wish to understand the Essence of my very being should read the clearly documented information presented years ago in my book, "THE ENERGY MACHINE OF JOSEPH NEWMAN."

I am humbled by the many letters and telephone calls of appreciation concerning my life's work that I have received from People across the nation.

★ For further proof of the "Truth" of the facts presented in this Report, see page 22 for the extensive list of organizations, universities and corporations that have purchased my book.

EXAMPLE.

6/16/86

Dear Mr. Newman:

I am a young man filled with ideas & hopes for a global "Merger Of Economics & Automation," I am back in school (MS-PhD) in Artificial Intelligence to make it a reality. I keep your book The Energy Machine close on hand at school, (with my own book of purpose) to remind me of the ever present transcendent reality in the midst of a society which is mundane. Your book brings me back to myself again, and sets an example for my life, i.e. how I wish to live it, by "challenging." It was right, correct to include everything you included in your book tying a view of the

As I have often stated to those closest to me:

"Offer me two paths — one which makes it easy for me and hard for the People and one which makes it hard for me and easy for the People, and I will choose the hard road for myself every time."

I am now faced with traveling upon a road of Politics and its political games that are an affront to my very nature. I approach this course with hard determination as though I had been compelled to dig a ditch by hand from the backwoods of Lucedale, Mississippi to the White House in Washington, D.C. But this course I eagerly pursue to serve Humanity.

I humble myself before God to guide me effectively, to bring harmony where there is discord, to bring exact and precise solutions to the heart of a problem (in place of feeble attempts only applied to the outer periphery of problems), to bring Love where there is hate, Truth where there are lies, Peace where there is war, Hope where there is hopelessness, to untiringly serve Humanity and to awaken the Majestic Sleeping Lion of the "People's Mind" by making them aware of their individual and unified greatness for the good and well-being of "All."

I am 51 years of age and I am in extremely good condition for my age. I ask for your help and support through any or all of the following means:

- 1) Send contributions to the JOSEPH NEWMAN PRESIDENTIAL CAMPAIGN.
- 2) Volunteer to establish political campaign offices or help in each city and area.
- 3) Get others involved.
- 4) Get radio, TV stations, newspapers, and magazines involved.
- 5) Get your Congressmen and Senators involved.
- 6) According to the Federal Campaign Rules, to qualify for matching funds (up to \$11 million) from the U.S. Government, it is necessary to have a minimum of 20 people from 20 states contribute a minimum of \$250 each. Please assist me in reaching this goal in any way that you can.
- 7) Please make at least two copies of this Report, send to two friends and ask them to do the same. In this way, this information will reach across America.

Thank you!

Joseph Vestley Newman

Joseph Westley Newman

entire world together rather than further fragmenting it. Chapters on "proper teaching" & "Pursuit of Truth" are equally important to the 2 message of your book as the scientific chapters were. You are a genius, a great man in 'all' time as opposed to just 'our' time and humble before God. So may it be for you always.

Yours,
Ron Wachman

R. Wachman
Georgia Institute of Tech
P.O. # 34375
Atlanta, GA 30332



SYNOPSIS OF NUMBERED FACTS 1 - 45

- FACT 1:** Joseph Newman's technology converts matter to energy on a 100% basis
- FACT 2:** FACT 1 is said to be impossible
- FACT 3:** Explanation of benefits of Joseph Newman's technology
- FACT 4:** Why politicians and bureaucrats attempt to stop the technology
- FACT 5:** Joseph Newman's fundamental book was first published in **1984**
- FACT 6:** Worldwide publicity concerning Joseph Newman's work
- FACT 7:** Approximately 8,000 individuals/organizations have purchased Joseph Newman's book
- FACT 8:** Under the guise of Superconductivity, certain individuals attempt to patent infringe
- FACT 9:** KHOU-TV broadcasts in Houston concerning Chu's claims
- FACT 10:** Chu files a patent claim in January, **1987**
- FACT 11:** Chu's pioneering patent claim is a fraud
- FACT 12:** Chu called Joseph Newman in the **Fall, 1985** seeking information on Superconductivity
- FACT 13:** What Joseph Newman teaches about Superconductivity
- FACT 14:** Chu said he had a copy of Joseph Newman's book; the most efficient conducting design
- FACT 15:** Scientific statements from "THE ENERGY MACHINE OF JOSEPH NEWMAN" book
- FACT 16:** Further proof that Chu called Joseph Newman in the Fall, 1985
- FACT 17:** Technical methods of achieving Superconductivity as described in **1982** by Joseph Newman
- FACT 18:** *USA TODAY* quotes re Chu; connections between University of Houston/University of Alabama at Huntsville/REDSTONE MISSILE COMMAND/S.D.I. ("Star Wars")/FREEDOM OF INFORMATION ACT/NASA/National Science Foundation
- FACT 19:** Chronology of Superconductivity technology developments and Joseph Newman's work
- FACT 20:** Quotes from scientific community concerning recent advancements in Superconductivity
- FACT 21:** Joseph Newman's teachings re Superconductivity as quoted from his book
- FACT 22:** IBM and BELL LABS involvement; Joseph Newman told Chu in **1985** to utilize "pressure"
- FACT 23:** Wide dissemination of "THE ENERGY MACHINE OF JOSEPH NEWMAN" book
- FACT 24:** Joseph Newman originally describes his Superconducting technology in his **1979** Patent Application; PATENT LAW 102 quoted
- FACT 25:** Special Master quoted
- FACT 26:** Two cartoons and two articles of interest
- FACT 27:** The essence of Superconductivity
- FACT 28:** The nature of the injustice against Joseph Newman
- FACT 29:** Reagan's involvement in the theft of the Superconductivity technology from J. Newman
- FACT 30:** Quigg's & Jackson's injustice to Joseph Newman and humanity
- FACT 31:** More facts concerning Donald Quigg/Thomas Penfield Jackson/Ronald Reagan
- FACT 32:** Reagan's actions "behind-the-scenes"
- FACT 33:** Distribution of this Report
- FACT 34:** The effect generated by the opposition to Joseph Newman's technology
- FACT 35:** Why this opposition and injustice must be rectified
- FACT 36:** Why the Superconductivity thieves are **still** pursuing the wrong technological course
- FACT 37:** How Superconductivity technology should really be developed
- FACT 38:** Astronomical confirmation of Joseph Newman's astronomical writings
- FACT 39:** Space travel demonstration in Mobile, Alabama
- FACT 40:** Misuse of technology by Reagan and his cohorts
- FACT 41:** Why Joseph Newman thanks his enemies for their actions
- FACT 42:** Stockbrokers are being contacted concerning Joseph Newman's technology
- FACT 43:** Actions that people should take concerning this issue
- FACT 44:** The real purpose of Joseph Newman's technology
- FACT 45:** Joseph Newman's candidacy for President of the United States

★ For further proof of the "Truth" of the facts presented in this Report, see page 22 for the extensive list of organizations, universities and corporations that have purchased my book.

**KEY TECHNICAL ORGANIZATIONS/UNIVERSITIES/CORPORATIONS
WHO HAVE PURCHASED PUBLISHED COPIES OF
"THE ENERGY MACHINE OF JOSEPH NEWMAN"**

**Both NASA and the National Science Foundation (NSF) have been eminently aware
of Joseph Newman's work since the late 1960s and throughout the 1970s.**

CODE C G L M O P R U	— ORGANIZATION —	DATE ORDERED
	R Alph Technical Consultants, Metairie	June 1985
C	C.R. Allen and Company, Inc., New York, NY	June 1985
C	Eastman Kodak Company, Rochester, NY	June 1985
	R Engineering Dynamics Corporation, Lowell, MA	June 1985
	R IBM, Charlotte, NC	June 1985
	R Integrity Electronics & Research, Buffalo, NY	June 1985
	R Ivy Development Corporation, Evanston, IL	June 1985
	R Lawrence Berkeley Laboratories, Berkeley, CA	June 1985
	(After studying the book, L.B. Labs spoke with Electrical Engineer with WWL-TV, New Orleans, LA, to arrange for a group from University of California and Berkeley Laboratories to visit with Mr. Newman)	
C	McIlvaine Electronic Security Systems, St. Charles, IL	June 1985
C	Rolls Royce, Inc., Atlanta, GA	June 1985
C	Sinclair Corporation, St. Louis, MO	June 1985
M	U.S. Naval Station, Brooklyn, NY	June 1985
	R Walker Magnetics Group, Inc., Worchester, MA	June 1985
O	Bay Tex Energy, Houston, Texas (2 books)	July 1985
P	Chicago Power & Process, Inc., Arlington Heights, IL (10 books)	July 1985
C	Control Data Corporation, Waltham, MA	July 1985
	U Indiana University, Mishawaka, IN	July 1985
L	Libertarian Library (University of Houston vicinity), Pasadena, TX	July 1985
	U Montana State University, Department of Electrical Engineering, Bozeman, MT	July 1985
C	Stockton Chemical, Inc., Katy, TX	July 1985
	R TEK Services, Woodland Hills, CA (15 books)	July 1985
C	Tubemakers of Australia Ltd., BTM Division, Kilburn, South Australia	July 1985
	U University of New Orleans, Department of Physics, New Orleans, LA	July 1985
	R Allied Bendix Aerospace, Towson, MD	August 1985
L	American Liberty Information Society, Washington, D.C.	August 1985
	R Boehringer Laboratories, Inc., Wynnewood, PA	August 1985
	R Ecodynamics U.S.A Inc., Wayne, PA	August 1985
C	Electrical Industrial Wiring, Salt Lake City, UT	August 1985
	P EPM Power Systems, Ivanhoe, Australia	August 1985
C	Florida Progress Corporation, St. Petersburg, FL	August 1985
	R IEEE (Institute of Electrical & Electronic Engineers), New York, NY	August 1985
	R Newell Magnetics, Inc., San Antonio, TX	August 1985
C	Schaevitz Engineering Company, Camden, NJ	August 1985
C	Sears-Westall Company, St. Louis, MO	August 1985
	O ARCO Oil Company (Chairman of the Board), California	September 1985
	R Babcock & Wilcox Company, Seville, OH	September 1985
C	Barnes Engineering, Inc., Westlake, LA	September 1985
C	Kyocera International, Inc., San Diego, CA	September 1985
C	MICA Corporation, Culver City, CA	September 1985
M	Naval Weapons Center, China Lake, CA	September 1985
	P Pfeiffer Electric Company, San Jose, CA	September 1985
	R Rex Research, Berkeley, CA	September 1985

C = Corporatons (misc./elec./enrg.)
G = Government Agencies (non-military)
L = Libraries
M = Military

O = Oil Companies
P = Power Companies
R = Research Institutes
U = Universities/Colleges

CODE		— ORGANIZATION —	DATE ORDERED						
C	G	L	M	O	P	R	U		
						R		RTE Corporation, Research & Development Center, Waukesha, WI	September 1985
C								Sounder Electronics, Mill Valley, CA	September 1985
C								Sunburst Falls Energy Center, Walton, IN	September 1985
						R		Associated Technologies & Marketing, Inc., Baton Rouge, LA	October 1985
C								Branch Area Careers Center, Coldwater, MI	October 1985
					O			Chevron USA, Inc., New Orleans, LA	October 1985
					P			Gulf Power and Energy, New Orleans, LA	October 1985
						R		Intellicom, Chatsworth, CA	October 1985
C								C. Itoh & Company Limited, British Columbia, Canada	October 1985
	L							John F. Kennedy Memorial Library, California State University, Los Angeles, CA	October 1985
C								Laine Electronics, Inc., Metairie, LA	October 1985
						U		Louisiana State University Medical School, New Orleans, LA	October 1985
C								J.A. Majors Company, Distributor of Medical & Scientific Books, Houston, TX	October 1985
					O			Mobil Oil Company, Inc., New Orleans, LA	October 1985
						R		Modine Manufacturing Company, Research Department, Racine, WI	October 1985
						R		Sperry Corporation, Blue Bell, PA	October 1985
					O			Transco Exploration Company, New Orleans, LA	October 1985
						R		Alpha Omega Research Foundation, Inc., Palm Beach, FL	November 1985
						R		AVCOM, Manitoba, Canada	November 1985
						R		B&B Research Services, Pennsville, NJ	November 1985
C								Ballew Marine Designers, Inc., Federal Way, WA	November 1985
						U		Chicago Medical School, University Health Sciences, Chicago, IL	November 1985
	M							Coast Guard Reserve Center, New Orleans, LA	November 1985
						R		Delta Spectrum Research, Inc., Virginia Beach, VA	November 1985
C								Electrical Industrial Wiring, Salt Lake City, UT	November 1985
						R		Electronic Laboratories, University, MS	November 1985
						R		The Institute, New Orleans, LA	November 1985
C								KW Control Systems, Inc. Middletown, NY	November 1985
						R		Magnetics Research International	November 1985
C								S.A. Editions, Belgique, France	November 1985
					P			Southside Electrical Company, St. Louis, MO	November 1985
						R		Systems Research Corporation, Sun Valley, CA	November 1985
	M							U.S. Navy, New Orleans, LA	November 1985
						R		American Scientific Lighting Corp., Brooklyn, NY	December 1985
	M							Electronic Defense Technology, Fresno, CA	December 1985
		L						Free Library of Philadelphia, Philadelphia, PA	December 1985
						R		Institute of Gas Technology, Chicago, IL	December 1985
						R		Polestar Magnetronics, Inc., Ontario, Canada	December 1985
		L						Portland State University Library, Portland, OR	December 1985
C								Energy Refractors, Reedsville, OH	January 1986
C								Medtronic, Inc., Minneapolis, MN	January 1986
		L						University of Delaware Library, Newwash, DE	January 1986
C								Xenex Corporation, Kanehe, HI	January 1986
					O			ARCO Resources Group, Plano, TX	February 1986
C								AZ Industries, Inc., Temecula, CA	February 1986
					P			Duke Power Company, Cornelius, NC	February 1986
						U		Georgia Institute of Technology, Atlanta, GA	February 1986
						R		Krmeg Research, Portland, OR	February 1986
	L							Library of Congress, Washington, D.C.	February 1986

C = Corporations (misc./elec./enrg.)
G = Government Agencies (non-military)
L = Libraries
M = Military

O = Oil Companies
P = Power Companies
R = Research Institutes
U = Universities/Colleges

CODE	— ORGANIZATION —	DATE ORDERED
	U Oakwood College, Department of Chemistry, Huntsville (Chemistry Professors also teach at University of Alabama, Huntsville)	February 1986
L	OMC Marine Engineering, Outboard Section, Technical Library, Waukegan, IL	February 1986
M	Rockwell International Corporation, Collins Defense Commission, Cedar Rapids, IA	February 1986
G	U.S. Bureau of Reclamation, Engineering & Research Center, Denver, CO	February 1986
P	Mississippi Power & Light Company, Jackson, MS	March 1986
P	Mississippi Power Company, Gulfport, MS	March 1986
U	University of Evansville, Evansville, IN	March 1986
U	University of Saskatchewan, Saskatchewan, Canada	March 1986
P	Utah Power & Light Company, Salt Lake City, UT	March 1986
P	Atlantic Electric Corporation, New Jersey	April 1986
L	Louisiana State University Library, Baton Rouge, LA	April 1986
P	Singing River Electric Power Association, Lucedale, MS	April 1986
P	Alabama Power Company, Birmingham, AL	May 1986
C	National Advanced Systems, San Jose, CA	May 1986
R	R.H.S. Electronics, Green Bay, WI	May 1986
C	Rebound Dynamics, Inc., Lynwood, WA	May 1986
C	Softrol, Inc., East Ellijay, GA	May 1986
R	Argonne National Laboratories, Argonne, IL	June 1986
C	Capri Electronics, Canon, GA	June 1986
C	Denistron Corporation, Torrance, CA	June 1986
C	Diasonics, Inc., MRI Division, San Francisco, CA	June 1986
R	Institute of Technology Development, Jackson, MS	June 1986
C	Selectronics, Inc., Wadesboro, NC	June 1986
C	Sola Mente, Inc., Iowa City, IA	June 1986
G	U State of Alaska, Division of Geophysical Surveys, Eagle River, AK	June 1986
R	Wind Energy Systems, Moscow, ID	June 1986
U	California State University, Associated Student Bookstore, Chico, CA	July 1986
C	Armadillo Engineering, Mt. Clemens, IL	August 1986
C	Cambion Industries, Inc., Palo Alto, CA	August 1986
C	Energy & Procurement Service, Boise, ID	August 1986
C	Freeport GCI, Inc., Freeport, TX	August 1986
R	Fridhill Research AB, Dalby, Sweden	August 1986
C	Industrial Electric Equipment, Inc., Dallas, TX	August 1986
C	Motion Technology Corporation, Aston, PA	August 1986
R	The Rutherford Institute, Manassas, VA	August 1986
R	Solid State Technologies, Howell, MI	August 1986
C	Sonte Engineering, Bixby, OK	August 1986
R	Spectrum Research Company, Atlanta, GA	August 1986
O	Todd County Oil Company, Long Prairie, MN	August 1986
R	Unique Technologies, Richland, MI	August 1986
C	Universal Solar Products Company, Conyers, GA	August 1986
R	Advanced Manufacturing Systems, Inc., Raymond, MS	September 1986
R	Alternate Energy Research, Chino Valley, AZ (20 books)	September 1986
R	Basic Research, Marsta, Sweden	September 1986
U	Chubu University, Department of Engineering Physics, Kasugai, Aichi, Japan	September 1986
C	Pluskota Electric Company, Worth, IL	September 1986

C = Corporations (misc./elec./enrg.)
G = Government Agencies (non-military)
L = Libraries
M = Military

O = Oil Companies
P = Power Companies
R = Research Institutes
U = Universities/Colleges

CODE	— ORGANIZATION —	DATE ORDERED
C G L M O P R U		
M	United States Army, Red Arsenal Scientific Library, U.S. MISSILE COMMAND, Huntsville, Alabama (2 books) (It is standard practice for the faculty of the University of Alabama at Huntsville to use the Red Arsenal Scientific Library facilities and vice versa.)	September 1986
	U University of Linkoping, Sweden	September 1986
	U University of Sussex School of Engineering, East Sussex, England	September 1986
C	Curtis Instruments, Inc., Mt. Kisco, NY	October 1986
	R Electrostatics, Inc., San Diego, CA	October 1986
	R Sperry Corporation, Defense Products Group, St. Paul, MN	October 1986
C	Summit Industries, Inc., Lawrenceville, GA	October 1986
C	Texas Instruments, Plano, TX	October 1986
C	Whisper Electric Car AS, Kungsbacka, Sweden	October 1986
	U Aorangi International University, Dunedin, New Zealand (2 books)	November 1986
	R Dana Corporation, Center of Technology, Ottawa Lake, MI	November 1986
	U East Mississippi Junior College, Mayhew, MS	November 1986
P	The National Power Company Library, Reykjavik, Iceland	November 1986
C	Northern Energy Homes, Inc., Norwich, VT	November 1986
P	Pearl River Valley Electric Power Co., Columbia, MS	November 1986
C	Cutter Information Corporation, Arlington, VA	December 1986
C	Eaton Corporation, San Jose, CA	December 1986
	U Delgado Community College, New Orleans, LA	January 1987
	U West Georgia College Bookstore, Carrollton, GA	January 1987
	R Westinghouse Electric Corporation, Monroeville, PA	January 1987
	U Cornell University, Space Science Building, Ithaca, NY	February 1987
	U Georgia Southern College, Physics Department, Statesboro, GA	February 1987
	U Brown University Bookstore, Providence, RI	March 1987
	R Delawarr Laboratories, Ltd., Oxford, England	March 1987
	R DeVry Institute of Technology, City of Industry, CA	March 1987
	U Northeast Junior College, Sterling, CO	March 1987
G	State of Mississippi, Department of Energy & Transportation, Jackson, MS	March 1987
C	Henry Hurley Electric Company, Detroit, MI	April 1987
C	Lockheed Corporation, Marietta, GA	April 1987
	U University of Alabama, ISE Department, Huntsville, AL	May 1987
	U Tarrant County Junior College, Hurst, TX	June 1987
	U Central Missouri State University, Physics Department, Warrensburg, MO	July 1987
C	Informatics, Bangalore, India	July 1987
C	MBB Helicopter Canada Ltd, Ontario, Canada	July 1987
	U New Brunswick Community College, New Brunswick, Canada	July 1987
	U University of Washington Bookstore, Seattle, WA	July 1987

C = Corporations (misc./elec./enrg.)	O = Oil Companies
G = Government Agencies (non-military)	P = Power Companies
L = Libraries	R = Research Institutes
M = Military	U = Universities/Colleges



WHOLE LIFE EXPO presents:

ENERGY MACHINE

☆☆☆ INVENTOR ☆☆☆

JOSEPH NEWMAN

Saturday, October 3rd, 1987
10:00 AM

Los Angeles Airport Hilton Hotel
(5711 West Century Blvd.)

For more info: (213) 451-1314

"An invention whose time has come!"

— *Non-polluting, abundant, & inexpensive energy* —

**The energy machine will
TOTALLY DECENTRALIZE our access to energy
and will have a profound socio-economic
impact upon our civilization.**



Joseph Newman is an original thinker who has the ability to visualize the mechanical essence of what he evaluates.

The Newman energy machine works successfully because "all mass is made up of electromagnetic energy, and if the proper, mechanically designed mechanism is built, one can change mass into pure electrical energy and/or rotational motion in a 100-percent conversion process." Joseph Newman's operational prototypes include an 1800-lb automobile powered by an "internal-combustion-free" energy machine motor, a home appliance fan, and units ranging in size from less than 3 lbs to over 9000 lbs.

Joseph Newman will present a technology that will be of major and dramatic benefit to all people by enabling us to have access to inexpensive, abundant, and non-polluting electrical energy at a fraction of the present cost.

This machine will replace **all** present forms of energy production. With the energy machine, all consumers could make a one-time purchase of a unit that could be installed in their backyards and virtually unplug themselves from local utility companies. The energy machine could also be utilized to power all land, sea, and air vehicles and would eliminate the polluting effects caused by the internal combustion engine and nuclear wastes.

As one of over 30 scientists who have endorsed the energy machine, Dr. Roger Hastings says:

"The future of the human race may be dramatically uplifted by the large-scale commercial development of this invention."

For free info write: NEWMAN ENERGY PRODUCTS, Route 1, Box 52, Lucedale, MS 39452.

SEE THIS EXCITING PRESENTATION AT 10:00AM ON SATURDAY, OCTOBER 3rd, AND LEARN WHAT YOU CAN DO TO ENSURE THE EXPANSION OF "AN INVENTION WHOSE TIME HAS COME!"



ORIFANS PHOTOGRAPHY

Joseph Newman with his 21st Century automobile



The following insertion of the front page of the MOBILE PRESS REGISTER (November 29, 1987) also exemplifies my warnings to the World concerning God's Wrath:

The Sunday Morning

MOBILE PRESS REGISTER

Printed 1987 by The Mobile Press Register, Mobile, Ala. Serving The South Since 1813 Vol. 175 No. 1 November 29, 1987 ★ Final — 75¢

Inventor Newman divines 'great destruction'

By RON COLQUITT
Press Register Reporter

Mississippi inventor Joseph W. Newman's program and "press release to the world" Saturday evening was a warning that a "great destruction to most life on this Earth will occur by 1999 if we continue on our present path." Newman had promised to "shock the world" by his revelations, but only about 150 people attended his program at the Expo Hall at Mobile Municipal Auditorium.

Newman, of Lucedale, has made national headlines in the past with an energy machine he claims produces more energy than it uses — a claim the U.S. Patent Office has refused to recognize.

Newman bases his beliefs mainly on predictions made by Nostradamus, a prophet who lived during the 1500s. Newman said that "after studying



Lucedale, Miss., inventor and presidential candidate Joseph Newman speaks Saturday night at Expo Hall in downtown Mobile. Press Register photo by Ron Colquitt

■ Please see Page 10, Col. 2

Newman

■ Continued From Page 1

a book (about Nostradamus) titled, 'The Man Who Saw Through Time,' I was amazed to find that Nostradamus predicted my very existence and purpose in life more than 400 years ago.' Newman now believes that God has directed him to seek the presidency and "save the world if people listen."

Because he believes God intends to destroy the world again, Newman sees himself as a modern-day Noah. "People mock God," he lamented. "There's going to be a lot of people who are going to laugh just like they did back in Noah's time. There were a lot of smug people who were stupid, ignorant and closed-minded."

He added that people in Noah's days didn't have "enough sense to come in out of the rain, and as a result of it, they died. The same thing is going to happen again. There's a lot of ignorance, a lot of pompous people who think they know a lot; think they know more than God, and that there is no

God. Now those people are going to die; not because Joe Newman said so, but because of the facts. I'm here to give the facts that God has directed me to, except there's a difference."

His knowledge of science helps him understand Nostradamus' predictions, he said. "I have worked on as a scientist, but way beyond that, God is directing this information to the world, to inform the world of things they have to do. 'It's obvious that if the world doesn't reform, in the year 1988, there will be a lot of earthquakes, volcanic eruptions, tidal waves, storms; you are getting a glimpse of that already. ... This is a warning from God, there's one thing God does, he keeps his word.' According to Newman, if mankind reforms, there won't be any destruction.

Newman claims that he is running for president because "God directed me to run for president." He said his chances of winning depend on the people. He maintains: "I'm not running to pump up Joe Newman, but most people miss that. I'm running to serve the people; if they want it fine, if they don't, see, that's fine. It doesn't bother me one iota."

According to Newman, God

has given the world a "last chance" based on facts predicted by Nostradamus. "He's (God) saying they are going to have to change. What I know is God is going to keep his word.

"God has given a date through Nostradamus and what's going on now. He's going to keep his word and the people who don't believe that, don't use their mind and look at the facts, they are going to have a wide awakening."

As president, Newman said he plans to spread his message through his book, films and literature. "If people like it they will spread it on their own and that's the way it has got to be spread," he said. Newman added that if people "stick their heads in the sand," then "great destruction across the world" will begin in six months and by 1999, "most life on earth will be gone."

Newman seemed disappointed that so few attended his program, and said the auditorium should have been filled. "When the earthquakes start happening, then when people hear what Joe Newman has been saying, they will say, 'maybe I ought to take a look now.' What's sad about it is so many children and innocent people will get killed as a result of that type of attitude."

A VHS or Beta Tape of Joseph Newman's presentation at the Expo Hall of the Mobile Municipal Auditorium can be purchased for \$15.00 which includes shipping and handling from Hartwell Video, 715 Jefferson Heights Avenue, Jefferson, LA 70121.

In addition, my continued warnings to the World concerning God's Wrath is further exemplified by a 30-page Blue-Covered Press Release which I sent to international news media and to the embassies of all major countries of the world in November, 1987. The following insertion represents this Blue-Covered Press Release:

PRESS RELEASE TO THE WORLD

☆☆☆ **MAJOR EARTHQUAKE PREDICTED** ☆☆☆

GREAT DESTRUCTION TO MOST LIFE ON THIS EARTH WILL OCCUR BY 1999 — IF WE CONTINUE ON OUR PRESENT PATH. HOWEVER, THROUGH GOD'S GREAT MERCY AND LOVE GIVEN THROUGH AND TO NOSTRADAMUS' VISIONS OF THE FUTURE AND JOSEPH NEWMAN'S GIFTS FROM GOD, THE HUMAN RACE CAN ACHIEVE PEACE AND HAPPINESS INSTEAD OF GREAT DESTRUCTION.

AS A RESULT OF ELECTROMAGNETIC INTERACTIONS, A PLANETARY ALIGNMENT THAT LAST OCCURRED 288,708 YEARS AGO WILL CAUSE GREAT EARTHQUAKE DESTRUCTION IN 1988.

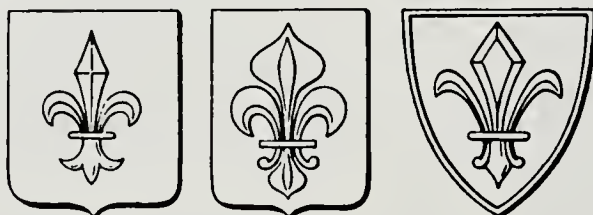

A B C

THREE MODIFICATIONS OF THE FLEUR-DE-LIS

(A) Middle ages (B) 17th Century (C) 18th and 19th Centuries

QUOTING FROM NOSTRADAMUS IN 1555 A.D. CONCERNING A GREAT LEADER WHO WOULD LIVE 400 YEARS IN THE FUTURE:

S-15

**"The newly elected father of the great ship
Will for a long time give illumination like a clear flame
Serving as a lamp to this great land,
And at that time the coat-of-arms belonging to his name
Will be linked with that of the happy one of Bourbon.
From the Levant to the Western Ocean and the land of the
Setting Sun his memory will be honored."**

X-42

**"The human rule of Angelic birth
Will base its power on peace and union,
War will be captive and half cloistered,
For a long time peace will be maintained among men."**

SUMMATION OF WHAT YOU WILL READ IN THIS REPORT:

- (A) Proof of the first paragraph above.
- (B) Proof of a 176-year, clockwork-record which will lead to Great Earthquake Destruction in 1988!
- (C) Proof that all religions who praise God must praise one another.
- (D) Facts that represent the equivalent of "reading the choice between a 'Happy' or a 'Tragic' end of a book" and yet watching the choice — being that of a tragic ending — unfold on a dally basis.

☆☆☆☆☆☆☆☆☆☆☆☆☆☆☆☆☆☆☆☆☆☆☆☆☆☆☆☆☆☆

IN WORLD WAR II, THE PROPHECIES OF NOSTRADAMUS WERE EMPLOYED BY THE GERMAN GOVERNMENT TO HAVE A NEGATIVE, PSYCHOLOGICAL EFFECT UPON THE FRENCH PEOPLE AND BY THE BRITISH AND AMERICAN GOVERNMENTS TO HAVE A POSITIVE PSYCHOLOGICAL EFFECT UPON THE PEOPLE OF THEIR NATIONS.

EXAMINE THE SOURCE OF OUR GREATEST THREAT TO WORLD PEACE TODAY. IN HIS PROPHECIES, NOSTRADAMUS SPECIFIED THAT THE WORST OF THE WORLD WARS WILL OCCUR AS A RESULT OF HATRED FROM THE LAND OF MOHAMMED. THE MATHEMATICAL ODDS OF NOSTRADAMUS SELECTING THE PLACE, YEAR, AND NATURE OF THE CONFLICT WITHIN FIVE YEARS OF THE EVENT, IS CONSERVATIVELY ESTIMATED AT 2000 TO 1 ODDS AGAINST.

INDEX

I. Nostradamus' Visions of the Future and Joseph Newman's Gifts from God (Possible world peace instead of great world destruction by 1999) ... Page 3
II. Unusual Devastation by Earthquakes, etc., in the year 1988 — Confirmed by the precise, 176-year, clockwork record of Earthquakes plus Unusual Planetary Alignment that last occurred 288,708 years ago ... Page 10
III. Economics (Fact 37) ... Page 19
IV. All Religions who praise God must praise one another. The present position in which religions condemn one another represents the greatest threat to world peace ... Page 22
V. Conclusion ... Page 28

★ ☆ ★ ☆ ★ ☆ ★ ☆ ★ ☆ ★ ☆ ★ ☆ ★ ☆ ★ ☆ ★ ☆ ★

FURTHER ASTOUNDING PROOF!

Upon completion and presentation of the information contained in this PRESS RELEASE to Joseph Culotta, WNOE, New Orleans, Louisiana and Ralph Hartwell, New Orleans, Louisiana on Saturday, October 31, 1987, both individuals informed me of astounding facts (Wayne Weible, Myrtle Beach, South Carolina) and/or film (Channel 8 in New Orleans, Louisiana) of which I had never heard.

The pertinent facts relative to my work follow:

- A. In Medjugorje, Yugoslavia, certain children for several years had been seeing and talking with an apparition of the Virgin Mary.
B. Others could not see the Virgin Mary, but could see the Sun appear to come out of its orbit, move around, spin, etc., in addition to other unexplained phenomena. [I challenge the Scientific Community of the World to accomplish the same feats!] In years past, similar observations had been seen in Fatima, Portugal and Lourdes, France (1917). These facts have been verified by people from around the world and several members of the Press!
C. The smallness of man is exemplified by the fact that the churches, newsmedia, and peoples of the World have not eagerly verified and endorsed the Godly events in Medjugorje, Yugoslavia! The Godly events are still occurring!
D. The children at Medjugorje are quoted as being advised to tell the world that Christian religions cannot love God and laugh at other religions.
E. The children were told that God was angry, that great catastrophe was about to occur upon the Earth, and that such catastrophe would be preceded in the near future by natural disaster.
F. And that (E) above can be greatly reduced by the immediate following of God's direction and prayer by the People of the World.
G. Observe how God provides a Three-Way Proof! These facts (A through F above) of a purely Godly nature verify the following facts: God's gifts through Nostradamus and God's gift of scientific ability to myself, all prove God's single message to the world. The same conclusion has been obtained from three different and independent directions.

God's astounding proof and warning to the World unfolds its absolute Truth from several different directions — Scientific and Godly. God's Mercy is so great and yet the World blindly runs towards its own devastation.

Minor earthquakes have now happened recently in New Orleans, Louisiana, Illinois, South Carolina, Michigan, Utah, Nevada, and I am sure in other places which have not been reported.

Anyone who doubts these facts, see the Channel 8 film produced in New Orleans, Louisiana, and the Fatima Film. BETTER YET, GO TO MEDJUGORJE, YUGOSLAVIA AND SEE IT FOR YOURSELF!

(Inexpensive tour groups are available in New Orleans, Louisiana and other places for those who need to 'see to believe.')



The following TV Documentary shown on Wednesday, November 4, 1987 and narrated by Bill Moyers, made me ashamed to be an American and furiously angered me with the Evil revealed. Such information provides ample reason as to why God is angered with the People of this World: **Because we the People allow these injustices to occur!**

Certain people of America endorse and praise Oliver North for having deceived and lied to the American People and Congress — actions directed by Reagan's Administration which in turn lied about actions causing great injustice and death to innocent people of Nicaragua and the selling of drugs to America.

The film clearly documents the fact that the World deserves the wrath of God which is going to befall the World in the very near future. I advise everyone who doubts my statements to view this film entitled, "THE CONSTITUTION IN CRISIS." The film's factual evidence goes hand-in-hand with the following information God has directed me to release to the World as well as with the Fatima and Medjugorje films that disclose the Virgin Mary advising the World that Satan has a free hand in this century.

close
up

MOYERS: THE SECRET
GOVERNMENT (CC)
8 PM 



North with counsel Brendan Sullivan

**THE CONSTITUTION
IN CRISIS**

The Iran-contra scandal, according to this Bill Moyers "essay," is the latest example of "clandestine military operations, the subversion of other governments, and dirty tricks [that] have become a permanent feature of national policy, carried out with no accountability to democratic institutions or democratic values"—no matter who is in the White House.

The program, subtitled "The Constitution in Crisis" (and still in production at press time), is scheduled to open with a recounting of the Iran-contra story, with clips of Lt. Col. Oliver North and others testifying at last summer's joint Senate and House hearings. Then, Moyers uses interviews and archival clips to put the problem into

historical perspective. Particularly important, he notes, was the 1947 National Security Act—which reorganized the Defense Department, set up the CIA and established the National Security Council in the White House; in addition, it gave Presidents, for the first time, the "secret means" to carry out policies that might not have the support of Congress or the American people.

The impact of these actions over the past 40 years in Chile, Guatemala, Iran, Vietnam and other nations is delineated next. In this segment, executive producer Alvin Perlmutter says, Moyers will assess the "cost" of these activities in terms of "loss of credibility, loss of lives" and their danger to our form of government. (90 min.)

TV GUIDE

I. Nostradamus' Visions of the future and Joseph Newman's Gifts from God (Possible world peace instead of great world destruction by 1999)

FACT 1: Joseph Newman has dedicated his life to the advancement of all of Humanity as is documented in his book, "THE ENERGY MACHINE OF JOSEPH NEWMAN".

FACT 2: For over 20 years, Joseph Newman has met severe resistance at the highest level of the U.S. Government, other governments, and portions of the scientific community against his objective of doing good for Humanity. Such opposition has resulted in Joseph Newman's unusual fighting spirit and fortitude concerning his determination for the good of Humanity to achieve his conquests over such resistance being documented by the newsmedia of the United States and even many foreign countries.

FACT 3: Joseph Newman's mother (presently 76 years of age), whose maiden name is Marguriette Ladner, had on many occasions when he was young, informed him that he had the blood of French kings running through his veins. Such lineage was derived from Christian Ladner, who founded Pass Christian, Mississippi. Joseph Newman had paid little or no attention to Christian Ladner or the fact that he was related to Christian Ladner.

FACT 4: Within the past few weeks, Joseph Newman was directed and inspired by God — in 'no uncertain way' in his mind — to run for the Presidency of the United States. Refer to Joseph Newman's Press Release (FACT 45, Page 19) of September, 1987. If you doubt this fact, look into my eyes in FACT 9 below and hopefully you will at least give me the benefit of the doubt that I sincerely believe this to be a Fact of Truth.

FACT 5: Approximately two weeks after Joseph Newman's direction and command from God, a reporter with the **GEORGE COUNTY TIMES**, Debbie Brokaw, came by my workshop on Friday, September 18, 1987. Debbie Brokaw took pictures concerning my running for President of the United States and at that time she anxiously and sincerely asked me if I believed the prediction of Nostradamus (of 1555 A.D.) concerning a tremendous war to occur by 1999 that would destroy most life on this Earth. I replied that I did not know and I would have to check on the facts concerning this prediction. Prior to this time, I had heard of Nostradamus but I had not bothered to study his work. This attitude was shortsightedness on my part.

Like me, you probably have or have had a "knee-jerk" type response that neither Nostradamus nor anyone else could "see through time." If you check the facts with an open mind, you will be amazed that Nostradamus had such an ability. The question now is, how could he? Nostradamus' ability is and was beyond scientific reasoning. Leaving the logic, one must conclude that it has been a gift from God.

FACT 6: Joseph Newman studied a book (especially the Chapter entitled "Purpose") on Nostradamus entitled, "**THE MAN WHO SAW THROUGH TIME**," by Lee McCann, copyrighted in 1941. I was amazed to find that Nostradamus predicted my very existence and purpose in life more than 400 years ago.

Does this statement shock you? I can assure you that it shocked me infinitely more! I examined the works of Nostradamus to learn the possibility of facts concerning the destruction of most life on this Earth within the next twelve years — not only do I find those facts, but I also find shocking facts that my life and existence was predicted 400 years earlier and is intertwined with the choice of happiness or destruction across this Earth within the next 12 years.

FACT 7: Most of the predictions of Nostradamus depict the tragedies that the Human Race inflicts upon itself because of greed, power, selfishness, and the non-use of the human mind.

FACT 8: The last paragraph of page 177 through page 181 of Lee McCann's book shows Nostradamus to have the greatest hope for Humanity through an individual that he knew would exist 400 years from his time of 1555 A.D. [I was 19 years old in 1955.]

To specifically quote Nostradamus:

"Four centuries separate him and me. By such standards of time, I become a very ancient man compared to him. So I hope that he would not, if he knew, take it as an unbecoming liberty, that I should love him as a son."

I am humbled and moved by the sensitivity of Nostradamus. I can imagine the hurt he felt from Humanity, envisioning all the hurt which we consistently impose upon one another. And how much more so the hurt for God, who gave Nostradamus the vision to know the tragedies which he saw for Humanity **did not have to happen** if Humanity used its mind properly and chose a path away from such tragic results. Such was verified in a letter Nostradamus wrote to his young son just prior to Nostradamus' death. The facts demonstrate to me that God allowed Nostradamus to see tragic events that would or would not happen depending upon our behavior.

At this instant in time, we clearly have two paths that we can choose:

A. One of Great Destruction across this Earth!

B. The other of Great Happiness across this Earth!

FACT 9: Within pages 177 through 181 of the Lee McCann book, Nostradamus stated that this individual — beneficial to Humanity — would have some of the following characteristics:

- (A) *“And searching his face, I find there, Justice, sympathy and the wisdom to serve his people.”*

[The picture at right is taken from the back pages of my book, “THE ENERGY MACHINE OF JOSEPH NEWMAN”.]

- (B) *“Will develop his ideals through repose and meditation.”*

[It has already been documented around the World that I live a secluded life of thought and meditation.]

- (C) *“That which fire and sword knew not how to achieve, His gentle speech will accomplish in council.”*

[The book, “THE ENERGY MACHINE OF JOSEPH NEWMAN” — which has been distributed around the world — documents that Joseph Newman teaches peace, not war through God’s directions, and promotes the use of the mind and love for one another. Joseph Newman has consistently taught that his Energy Machine would do more to bring World Peace than all the Kings, Queens, and Politicians who have ever lived!]

- (D) His fighting heritage and courage of ancient royal blood from France would be *“born into shadows of the times and secret effort.”* (“A son of ancient France and of the lineage of the fleur-de-lys.”) [Joseph Newman’s fighting courage has been documented by newsmidia around the world, and his French heritage, born into shadows of the time, is documented as described below.]

- (E) Nostradamus has also said that this individual’s leadership would be *“born under angelic birth”* which means - ***inspired by God.*** [See FACT 4 above — Joseph Newman was so directed to run for President of the United States.]

PHOTO BY MARY ANN WELLS



Joe Newman

FACT 10: Upon reading this material, Joseph Newman knew that Nostradamus spoke to him through 400 years of time and had seen and understood his essence and purpose more than any other human alive.

FACT 11: Upon wishing to document Nostradamus’ exact predictions more clearly, Joseph Newman traveled to Pass Christian on Tuesday, September 22, 1987, to the Chamber of Commerce, and then to the bookstore operated by the President of the Historical Society, Miss Cooper. Joseph Newman then went to the library in Pass Christian.

Because Joseph Newman has documentation of his heritage that is traced to Christian Ladner who founded Pass Christian, he was hopeful that he would be able to find exactly who Christian Ladner was and where he was from by studying the history of Pass Christian. Instead, Joseph Newman found the facts matched exactly what Nostradamus predicted, *i.e.*, “shadows” covered his heritage from that point to earlier times even though Christian Ladner had founded the area of Pass Christian. There were approximately four or five authors on the history of Pass Christian. As one author notes, “there seems to be as many versions of the Ladner Family as there are historians.” *Examples:*

- (A) Miss Cooper of the Historical Society said she had once heard that there used to be a plaque in Pass Christian which stated that two Ladner (spelled L’Adnier) brothers were removed from the d’Iberville French vessel in 1699 and were put ashore there. (The bronze plaque in front of Pass Christian’s City Hall now simply says, “PASS CHRISTIAN named for the channel of Deep Water Discovered in the Early 1700’s and named for Christian L’Adnier.)
- (B) Tradition also states that among d’Iberville’s officers, two Lieutenants Christian and Marianne Ladner (L’Adnier) were sent on February 7, 1699 to explore the bay to the West. [On many occasions, direct descendants of kings were made officers in the military.]
- (C) It is also stated that Nicholas Christian, one of the oldest settlers of New Orleans, founded Pass Christian and changed his name to Christian Ladner. Another source tells of a doctor, Dr. Christian Ladner, and still another tells of a Swiss National Landing which at the time was directed by France.

Heber Ladner is my fourth cousin. He used to live with my Grandfather, Jeremiah Ladner, when attending college.



STATE OF MISSISSIPPI
Secretary of State
POST OFFICE BOX 136
JACKSON, MISSISSIPPI 39208

HEBER LADNER
SECRETARY OF STATE

FOREWORD

More than 250 years have elapsed since the first Ladners came to what is now Mississippi. The descendants of these pioneer settlers have witnessed the course of Mississippi history from the French provincial era to the present day. I consider myself fortunate to be one of those descendants and am particularly grateful for having been given the opportunity to serve the people of this great state throughout my entire adult life.

Mr. Slade is to be commended for his thorough, tedious, and most exhaustive study of our family. It is my sincere hope that the readers of this volume will come to appreciate the sacrifices and the contributions of those who have gone before us and that they will be inspired to do their part in making this a better world for those generations yet to come.

HEBER LADNER
SECRETARY OF STATE

EDITOR'S NOTE: There is a confirmation record made at Deer Island, Mississippi dated 21 April 1798. Records "Louis Christian Ladner, age 100, son of Christian Ladner and Magdelaine _____." ... Mr. Slade

.....

[This would have put his birth to Christian Ladner and Magdelaine at 1698, which places his birth on the ship of Pierre Le Moyne D'Iberville, which landed in the area of Pass Christian in 1699 or shows that his father Christian Ladner could have been on La Salle's ship in that area in 1682 which would have resulted in his being born on the land in the area of Pass Christian. La Salle was sent by Louis XIV, King of France. It is my opinion that it is more logical that he arrived on La Salle's ship rather than D'Iberville's ship. Observe that the son, Christian Ladner's first name was Louis, evidently after the King, Louis XIV. — Joseph Newman]

In the 1680's, Protestants were being persecuted by the Government and many of the most prosperous and industrious persons of that time left France because they were Protestants.

NOTE: My ancestry dated back to this date is less than 150 years after Nostradamus predicted, "*born under shadows*" and exemplified further, on page 181 of the McCann book by Nostradamus' friend, Chavigny, "*This message of yours should mean all the world to him, 'born under shadows' as you say, Will he recognize it and see it for himself.*" [Refer again to FACT 3.] "*That is my home,*" Nostradamus told him. "*My purpose is that he should read it, and feel the ancient royal strength of Hugh Capet flow through his sword arm. My hope is to give him confidence of victory, the freedom for his people — our people.*" Nostradamus' hope is true. I did and do feel the ancient royal strength, even more than I have already demonstrated to the World from my past fighting spirit to benefit Humanity.

FACT 12: The first time that Joseph Newman researched this history, he found that his heritage matched exactly as Nostradamus predicted 400 years ago, "*born under shadows.*"

FACT 13: On page 178 of the Lee McCann book, Nostradamus said that the coming of this individual "*will carry the memories of Frenchmen back to that other ancient day of darkness when all seemed lost. I mean the times of Charles VII whom the Maid of Orleans restored to his throne. The king who drove out the English and built a greater France. His name will be on men's lips again and they will liken the conquests of the new monarch to those of Charles VII ... From the dark realm of old Charon the Phoenix will be reborn, the last and greatest of the firebird's sons ... For five hundred years no accounting will be made of him who was the ornament of his time, (Charles VII) ... Then there will come a sudden burst of brilliant light, And the age will be made very happy.*"

Upon reading Nostradamus' comments, it is obvious to me that he and others of his time thought extremely highly and lovingly of Charles VII, and amazingly his predictions were true because as one researches the history of Charles VII, there is no accounting of his greatness. Moreover, some comments are very negative, exactly as Nostradamus had predicted over 400 years ago. [Such negative comments were made even though Charles VII's life was intertwined with that of Joan of Arc, since he had backed her and believed she was directed by God.]

FACT 14: There is an old European saying, "*You can recognize the lion by his footprint.*" Joseph Newman's fighting spirit and fortitude has been documented by the newsmedia of America and many foreign countries. Many people, including U.S. and foreign members of the press have commented in amazement about the same.

FACT 15: On the top of page 181 of the Lee McCann book, Nostradamus states that this individual will be "*fifth of his name and last of his rank before the second coming of Christ.*" [I am not sure how or why "*fifth of his name*" was used as Nostradamus knew it would be approximately five hundred years from the active lifespan of Charles VII, but undoubtedly there was some method for computing this available to him at the time. Could this comment have something to do with five centuries or possibly the name "Joseph" of that blood line?

FACT 16: Relative to the information published in my book, "THE ENERGY MACHINE OF JOSEPH NEWMAN," and my verbal statements on radio and television shows across the world, several sensitive individuals have called or written to inquire if I was the second coming of Christ. As I quote in my book, I am nothing but a mere man and all that I am is a gift from God. God expects me to use my talents for the benefit of Humanity.

FACT 17: On Sunday, September 20, 1987, Joseph Newman received a tape from Ralph Hartwell of New Orleans, Louisiana, concerning a documentary narrated by Orson Wells of the life of Nostradamus. This film, coupled with the books I have read about Nostradamus, prove totally to me as a scientist that there is no way Nostradamus could have seen and known the inventions, countries, people and their events-to-come without the inspiration and guidance of God. My opinion as a scientist is that anyone who believes otherwise is deliberately deceiving themselves, because the facts cannot be deceived.

EXAMPLE:

A book on Nostradamus written by David Pitt Francis, copyrighted 1984-1985, attempts to discredit God's direction to Nostradamus' predictions and attempts to explain-them-away by the mere mathematics of probability. This is ridiculous. Francis' attempted negativity only proves, not disproves, God's guidance to Nostradamus. On Page 276 of the Francis book, the author negatively reflects upon Nostradamus concerning his prediction that within 500 years an interpreter would arise who would provide a great "revelation" about his work. Francis writes that this had not actually been done and he calculated the termination time of this prediction to be about 1987.

As quoted on page 277 of the Francis book, the author states, "The most appropriate date for an 'inspired' interpretation of the Centuries is therefore shortly before 1987/88, too late for the many claimants of the age, but just before Nostradamus' date for the end of the world (1997)." [EDITOR'S NOTE: Nostradamus says that most life will be lost — he does not predict the end of the world. Moreover, Nostradamus predicts 1000 years of peace and happiness thereafter.]

FACT 18: I swear with all my being that I believe the following is the “Revelation” concerning the purpose and the essence of God’s great gift to Nostradamus:

The road we choose for the destination of the Human Race to a thousand years of peace can be preceded by great destruction and havoc across this Earth or we can take the opposite road — one which shines like a great light and gives us a glimpse of the peace and happiness we will achieve for Humanity in the thousand years thereafter.

It humbles me and exemplifies God’s great mercy that he has in the same span of time given Nostradamus the ability to **see two pictures** — one of great devastation and an opposite one of great happiness. I am the vessel that God wishes to offer to the Human Race to guide them to the beautiful expression of his blessing and mercy rather than the devastation and the tremendous heartbreak that will surely result if we continue to be uncaring, unthinking, and unresponsive to the merciful direction of God.

I can state clearly and honestly from my being and the inspiration that God gives me that we will most certainly experience this great devastation if we do not change immediately. The time to “pay the piper” draws dangerously near. The choice is ours. I have no doubt with the information I have written in my book prior to receiving this obvious “revelation” from God that God has directed me through my experiences in life and that God has instilled in me an ancient birthright which has given me the fortitude to taste the bitterness of life and to see beauty where misery now exists. When I wrote my book, “THE ENERGY MACHINE OF JOSEPH NEWMAN,” I thought I could live my life, die, and let the young grow up with the Truth of my teachings inspired by God. Now God has revealed to me that I have very little time. The World has less than 12 years! I say again, **it does not have to happen!**

FACT 19: The facts of my life and of my inspired teachings of God’s love and God’s gift of our mind, that we can have peace and happiness by simply doing the teachings of God, that all religions that praise God must praise each other, and that to do other than this is an affront to God, is clearly documented in my book, “THE ENERGY MACHINE OF JOSEPH NEWMAN” which has already been distributed around the World.

Therefore, without knowing of Nostradamus’ predictions, I have already existed and do now exist exactly as Nostradamus predicted more than 400 years ago. However, so does the great possibility of tremendous havoc and destruction of material things (that the Human Race still worships) as well as most life on this Earth by fire and its equivalent.

****NOTE:** Contrary to the detractor of Nostradamus, David Pitt Francis, this “revelation” is dated October 14, 1987.

I have absolutely no doubt that all I have experienced during the last several weeks concerning my running for President, Nostradamus, and my life’s work has been totally inspired to me by God — which I say very humbly. I clearly understand these “revelations” from God concerning Nostradamus’ prophecies inspired to him by God.

FACT 20: The facts clearly demonstrate that God has consistently warned that the Human Race must do as he has directed all peoples of the world through their prophets and Godly-inspired individuals to do — be good and love one another. I have stated even before these facts in my book, “THE ENERGY MACHINE OF JOSEPH NEWMAN” by looking at the facts of life that this was a factual truth of God, God’s mercy through the gift that he gave Nostradamus has consistently and repeatedly shown to us that if we do evil and are uncaring to each other that evil and destruction would consistently happen to us not by God’s act, but by our act of uncaring, unthinking, and unlistening.

In spite of all the injustices that we have done to each other since Nostradamus’ time, we still deliberately and premeditatedly do not care for one another even at this date. We stand on the threshold of total destruction to most life on this planet. The Orson Wells-narrated film, “*The Man Who Saw Tomorrow*,” [available through WARNER BROTHERS, INC., Burbank, California, A David L. Wolper Production, or available through Video Rental stores], shows this fact so explicitly that anyone who views it with honesty for truth would feel almost a hopelessness, since the film does not show the extreme hope that Nostradamus had for Humanity when he described an individual to be living 400 years from 1555 A.D. [I was 19 years old in 1955.] I challenge any disbeliever to view this film! You can closemindedly attempt to discard the blatant facts and you will find that you are squirming inside yourself.

Even more interesting relative to the fulfillment of Nostradamus’ prophecies, is the fact that after I had searched five more books on Nostradamus, I observed that they also all missed the most important and hopeful prediction of Nostradamus. Those books are as follows:

- (A) *THE PROPHECIES OF NOSTRADAMUS*” by Ericka Cheetham, © 1973
- (B) “*THE COMPLETE PROPHECIES OF NOSTRADAMUS*” by Henry C. Roberts, © 1947 through 1982
- (C) “*THE PROPHECIES OF NOSTRADAMUS*” by Avenel, © 1980
- (D) “*PROPHECIES ON WORLD EVENTS BY NOSTRADAMUS*” by Stewart Robb, © 1961
- (E) “*NOSTRADAMUS — PROPHECIES OF PRESENT TIMES*” by David Pitt Francis, © 1984 and 1985

The book (E) by Francis is an effort to disprove that Nostradamus had a gift of prophecy from God. Francis, of all people, should have had a strong interest in the fact that no such individual as quoted in FACTS 8 and 9 above had ever

existed or been disclosed at the recent writing of his book. Obviously he and other writers did not know of said prediction.

Observe that because said prediction has not been highly publicized, then few people know of it. This has allowed me, my good work for Humanity, and my fighting spirit to go unnoticed or unconnected with respect to Nostradamus' prophecies.

Of course, such events now allow Nostradamus' Prophecy of Great Hope to have reached its maximum potential and to have the greatest impact upon the Human Race's eyes and brains being opened to its Great Truth and Mercy from God.

FACT 21: God's tremendous mercy is in the fact that even at this late time he offers the Human Race two astoundingly different roads to travel.

God has documented for us in no uncertain terms by our own "history of uncaring actions" and his predictions through Nostradamus that if we continue on a path of uncaring, we will suffer greater and greater destruction to Humanity. It should leave us with no doubt that if we continue on this path, great havoc will befall the entire world within the next twelve years! [For any who do not believe, view the film described in FACT 17!]

More than 400 years ago, Nostradamus pinpointed our greatest danger would at this time be in the land of Mohammad — and the devastation will be in the name of religion. God does not teach war, only man teaches **and practices** war. With courage, honesty, love, and all religions respecting each other, this war will not occur. **Peace will occur!**

FACT 22: It makes my heart heavy to know so positively that if we do not change immediately across the world that Humanity will reap upon itself a tremendous horror. The sadness I feel at that thought is most heavy and even has caused me to wonder how God has stood that heartache all these thousands of years to see the people God loves repeatedly bring heartache, sadness, and misery upon themselves. God knew they could simply do as God has directed them to do and that all lives would be peaceful, happy, and meaningful upon this Earth.

All the religions of this world teach that great misery will befall Humanity, but what they have all missed is that we will only reap this great tragedy by our actions, not by God's. Even at this late date — through God's mercy — God gives Humanity one last chance to use our God-given minds to see His Truth, His mercy, and His love and follow the path that God has so heartbreakingly, for thousands of years, attempted to teach us to follow.

All the different religions in the world including Christianity must all applaud one another. In the past and presently even within the religions of the world, they make a mockery of the great love of God. Members of all religions have and still kill each other! Man teaches war, not God. The great love of God is contaminated by the smallness of man.

FACT 23: When all the persons of the world and religions of the world praise one another for doing and teaching good to one another and all praise God, then we will-cause God to smile and to feel peace and not hurt and heartache. The prayer which I have prayed often to God over the years, "God let my actions cause you to smile," we should all pray and be so ashamed, as I have been ashamed at the hurt we have given Him and presently that we all condemn ourselves, and pray that our actions will change and demonstrate the warmth and love that allows God to smile.

As taken from page 248 of my book, "THE ENERGY MACHINE OF JOSEPH NEWMAN:"

'I will take the liberty of quoting the Biblical Peter, chief of the twelve apostles, and Jesus, who understood the true message of God:

'Then Peter opened his mouth, and said, "Of a truth I perceive that God is no respecter of persons: But in every nation he that feareth him, and worketh righteousness, is accepted with him."' (ACTS 10:34, 35)

"And Jesus himself said:

'Blessed are the pure in heart: for they shall see God.' (MATTHEW 5:8)

'Once again I repeat my constant prayer:

'God, give me the knowledge and wisdom to unite all people of this Earth to you and not the first one, no not the first one, from you.'"

FACT 24: There are those who will immediately upon reading this material react very negatively and attempt to discredit me and God's mercy and God's gift through Nostradamus.

My response is simple. I am as certain that I am correct as was Noah when he built the ark!

The mass population of his time thought Noah was ridiculous when he warned them and built his ark. When the devastation came they frantically wished to change their minds. "Too late!" The same will happen again (with fire and its equivalent) if we don't change immediately.

I wish to arouse all People to use their brains, look at the facts and be aware of your own inner awareness of what you feel about the entire world. Be aware of the rampant lies and deceit on the part of your Political, and even Church, so-called leaders.

Quoting from Nostradamus:

X-73

*“Past and present times together
Will be judged by the great Jehovah
The world in its late stage will be abandoned by him
And sentence will be past on the disloyal clergy.”*

FACT 25: The fighting spirit in me wishes to rally all People — Church Leaders, Political Leaders — to the cause to save Humanity from great devastation!

The time is short and I cannot serve God or Humanity with lies or cowardness, but only through absolute Truth, Love, Strength, and Action.

Will you, the People, elect me to be the President of the United States? The Warrior in me has no fear and I am totally confident of God's Mercy and Love for Humanity and want us to achieve happy results.

I have already devoted my life to and for you. I gladly give my life to lead the People of this World to happiness instead of devastation.

Will you rally with me?

FACT 26: The film on Nostradamus (FACT 17) notes that he was mystified by man's insatiable desire to build more and more destructive war devices for killing Humanity as new technology was developed. Such is exemplified by the Administration of Ronald Reagan. [See my PRESS RELEASE of September, 1987, announcing the Reagan Administration's attempt to steal my Energy Machine Invention for war instead of the benefit of Humanity, and my efforts to become President of the United States.]

The Reagan Administration also generates hate and pushes forward vigorously to fulfill Nostradamus' prediction of uniting the land of Mohammed against the United States and Europe, while at the same time removing defensive means from Europe. [See the file described in FACT 17.]

Observe that the Reagan Administration's evil actions against my Energy Machine Invention and Humanity has also fulfilled Nostradamus' Prediction, because I instinctively, vigorously, and fearlessly reacted. This resulted in my fighting spirit being observed throughout the world. [“You can observe the lion by his footprint.”] This has also resulted in worldwide distribution of my life's work — inspired by God — “THE ENERGY MACHINE OF JOSEPH NEWMAN.”

FACT 27: Nostradamus stated on page 180 of the Lee McCann book:

I-97

*“That which fire and sword knew not how to achieve
His gentle speech will accomplish in council
The king will develop his ideals through repose and meditation.
There will be no more enemy, nor sword, nor blood shed in battle.”*

The fact that I stay in seclusion and think has been documented by newsmedia from around the world. My book, “THE ENERGY MACHINE OF JOSEPH NEWMAN,” documents that I teach peace, not war, through God's direction and use of the mind.

FACT 28: We can have peace if we do something that is so simple — simply care and love one another and carry the attitude for every human being that if you hurt, I hurt for you and if you smile, I smile with you with great love for all Humanity. With a heavy heart as I sense that there is still the possibility that the Human Race will not listen, I beg all to listen to God and follow the mercy he has offered us all, for all Humanity.

It is so obvious to me that the choice is up to the Human Race. As I teach in my book, the Peoples of this World do not use the great gift of the mind that God has given us. You can still do the same concerning the astonishing facts God has given even up to this moment and attempt to deny their truth, by blindly not using your mind.

Again, will you rally with me?

II. Unusual Devastation by Earthquake, etc. in the year 1988 — Confirmed by the precise, clockwork, 176-year record of Earthquakes and an Unusual Planetary Alignment which last occurred 288,708 years ago.

FACT 29: A sample of Great Destruction will occur at different locations on the Earth in the year 1988! Such destruction will happen as a result of an unusual astronomical event which last occurred 288,708 years ago. [Destruction will include Storms, Earthquakes, Eruptions, and Tsunami.] All caring members of the press must use their influence and disseminate this information across the World. [One should also see that Nostradamus' film is shown worldwide.]

To all close minded scientists, religious leaders, political leaders and people who still reject these facts:

You should be advised that I consider myself simply a tool of God — a simple "messenger boy," if you please. You will be shockingly proven wrong and inadequate, because it is my belief that God will secure your attention within the first six months of 1988.

Many lives will be lost, because close minded individuals like yourselves did not properly warn the People of the World to take preventive safety measures.

To all the pompous scientists who will scorn these facts: You do not even understand the mere fruits of my years of labor that God has given to the World; your pomposity is ridiculously insignificant and inadequate in the eyes of God, and I am honest enough to admit that I am a mere human and tell you what I feel: The fighting spirit in me laughs at you! God will have not only your attention, but the attention of the entire world. The sad fact is that your pomposity will cost the lives of many people who believe you. A young girl's prayer in the great Alaska Earthquake after four awful minutes in March, 1964, will be repeated by thousands: "*Lord, that's enough now. Please stop it.*"

I readily concede that I am only a gift of God to Humanity and even before I knew of Nostradamus, I had already described the mechanical (electromagnetic) relationship of how earthquakes, volcanic eruptions, storms, etc., can be caused by planetary or stellar alignment, by going into opposite sunspot polarity, or by having electromagnetic fields associated with potential sunspots expand and collapse. [Refer to my book, "THE ENERGY MACHINE OF JOSEPH NEWMAN," pages 133-135 and 144-148.]

It is documented that in 1550 scientists and clergy taught that volcanic eruptions, earthquakes, and storms were considered to be an Act of God against Humanity, and even the so-called scientific community believed so or had no other doctrine to counter that which was taught. But in the 16th century Nostradamus predicted that a great earthquake would occur in May, 1988, **as a result of fire from the center of the Earth**. Such a now-proven scientific fact was not even proposed by the scientific community until the 1700s!

Scientists and unbelievers alike can observe my scientific work explaining the cause and effect of storms, earthquakes, and volcanic eruptions as shown in my book, "THE ENERGY MACHINE OF JOSEPH NEWMAN," pages 133-135 and 144-148. My work merges exactly with Nostradamus' predictions made over four centuries earlier concerning me, my life, and even the predictions of destruction by earthquakes, etc. Its Truth cannot be swept under the rug by closemindedness. All are a gift from God to Humanity!

The recent Los Angeles, California earthquake matches the cause and effect explanations provided in my book, "THE ENERGY MACHINE OF JOSEPH NEWMAN." Observe that the Earth had just crossed the Sun's equator into opposite sunspot polarity on September 23, 1987 and that Jupiter was only a couple of months past its closest point to the Sun and its fastest speed. In fact, Jupiter was so bright in the evening sky at that time, that it even looked unnatural against the noticeably fainter night sky. (Jupiter's orbit around the sun is 11.86 years.)

Both events should be viewed as a warning or, if you prefer, an omen of the statement given in Nostradamus' film in which he was quoted as predicting that a great earthquake would occur in May, 1988, and that devastation would happen at different places upon the Earth.

Another example is the Hurricane which struck England hard near the week of October 19, 1987 and was totally unexpected by the weather experts since the last time such a storm struck England was over 700 years ago. Observe that this event also happened less than one month after the Earth crossed the Sun's equator (September 23, 1987) into opposite

sunspot (potential) electromagnetic induction from the Sun into the Earth and its atmosphere and less than a half year after Jupiter reaches its closest point to the Sun.

FACT 30: I now simply quote from pages 146 and 147 of my book to show how God's gift to Nostradamus and myself coincide to warn and prepare Humanity and prove God's realness to Humanity and God's direction of universal love:

53-A. The reader should be aware that there was no orderly listing of the 'natural disasters' for which I was searching. Therefore, I simply listed such events under Months-of-the-Year. The 'Earthquake and Volcanic Eruption Disasters' and the 'Tornado and Hurricane Disasters' were arranged in separate 12-month periods. *Reason:* The Earth's mass (inertia effect) of solid material is far more resistant to change than the mass (inertia effect) of gas molecules in the Earth's atmosphere. I therefore expected an 'accumulation effect' for the Earth's solid material and a more 'instantaneous effect' for the atmosphere (gases) of the Earth. I was also certain that these natural events would occur in accordance with the Laws of Electromagnetic Induction. I also knew 1) the speed of the Earth, 2) the Earth's tilt with respect to the Sun, 3) when the Earth crossed the Sun's equator into opposite sunspot polarity, 4) the direction of the Earth relative to sunspots varied from month to month, and I was certain that these facts would prove the existence of the electromagnetic effect.

54-A. Return to Chart 53-B. Observe that a large number of earthquakes and volcanic eruptions (as Mt. St. Helens) began on March 21 when the Earth crossed the Sun's equator and entered opposite sunspot polarity. This caused an opposite electromagnetic induction effect into the Earth (*i.e.*, the Sun rotates every 28 days and sweeps sunspot induction into the Earth) as the Earth travels into a cumulative 'action-reaction effect' since the greatest number of sunspots occur 18 to 20 degrees from the Sun's equator. The Earth is more likely to be affected by the sunspots in April and May due to the position of the Earth relative to the Sun. As a result, this cumulative 'action-reaction effect' peaks upon the Earth in April and May. [See Nostradamus' prediction of a Great Earthquake in May, 1988.]

54-E. On September 21, the Earth again crosses the Sun's equator and is again under the influence of fewer numbers of sunspots. However, the Earth is now in opposite polarity with respect to the Sun and the Earth's speed is still increasing which increases the electromagnetic effect. Maximum sunspot activity occurs 18 to 20 degrees North and South of the Sun's equator and the Earth is most apt to be affected by such sunspots in October and November. However, curiously enough, the 'cumulative effect' lags behind that in the Spring. (See Section 54-A.) This lag is evident since the cumulative 'action-reaction effect' peaks in December and January. The difference in timing may be a result of the Earth's speed, *i.e.*, on December 21 the Earth is closest to the Sun (three million miles closer than on June 21) and the Earth's speed increases by 1800 miles per hour compared to its speed on June 21. This greater proximity and increased speed magnify the electromagnetic induction effect of the Earth into the Sun ('triggering effect') and vice versa from the Sun into the Earth which results in the increased 'cumulative effect' of volcanic eruptions and earthquakes peaking in December and January. Such peaking continues into February since the Earth's direction relative to the Sun begins to reverse on December 21.

54-F. From December 21 through June 21, the Earth travels farther from the Sun and decreases its speed around the Sun. Similarly, in accordance with their particular orbital year which differs from the Earth's orbital year, **the other planets will also alter their relationship with respect to the Sun which in turn causes increased/decreased sunspot activity. Such sunspot activity causes the Sun's electromagnetic fields to expand and collapse.** This is further complicated by the Sun's rotation every 28 days which causes a 'sweeping' electromagnetic induction effect into the Earth that is similar to the sweeping beam of a lighthouse.

The Facts I have presented clearly demonstrate the cumulative 'action-reaction effect' caused by astronomical electromagnetic induction which results in earthquakes and volcanic eruptions upon the Earth." (From "THE ENERGY MACHINE OF JOSEPH NEWMAN.")

FACT 31: At this point I will sum up some pertinent facts:

- (A) When planets travel above the Sun's equator, they reduce sunspots in that hemisphere of the Sun and induce Sunspots in the lower hemisphere of the Sun.**
- (B) And vice versa of (A) when planets travel into the opposite hemisphere of the Sun.**
- (C) (A) and (B) above results in the generation of continuing expanding and collapsing electromagnetic fields of the Sun. (In addition, this establishes stresses and/or reactions within the Earth and its atmosphere.)**
- (D) The Sun rotates every 28 days which compounds the effect of (A), (B) and (C) above.**
- (E) Contrary to what many scientists believe, sunspots do not create the electromagnetic fields. Planetary induction triggers electromagnetic fields within the Sun which then create Sunspots. If the planetary induction establishes a changing induction into the Sun, then an expanding and collapsing electromagnetic field is created within and from the Sun which will not even allow time for sunspots to form, but which would play havoc upon the Earth as a result of the expanding and collapsing electromagnetic fields generated from the Sun.**

These effects will occur in a devastating way in 1988 and possibly into 1989.

CHART 53-B

EARTHQUAKE AND VOLCANIC ERUPTION "DISASTERS" PLACED IN MONTHLY ORDER — DATES ARE HIGHLY SIGNIFICANT!

MARCH		APRIL		MAY		JUNE		JULY		AUGUST		SEPTEMBER		OCTOBER		NOVEMBER		DECEMBER		JANUARY		FEBRUARY	
YEAR	DAY(S)	YEAR	DAY(S)	YEAR	DAY(S)	YEAR	DAY(S)	YEAR	DAY(S)	YEAR	DAY(S)	YEAR	DAY(S)	YEAR	DAY(S)	YEAR	DAY(S)	YEAR	DAY(S)	YEAR	DAY(S)	YEAR	DAY(S)
1977	4	1906	?	1976	6	1956	10	543	9	1949	5	1262	1	530	6	1755	1	856	?	1962	10	1783	4
1963	17-21	1906	16	1902	8	1948	28	551	9	1868	13	1923	1	1737	11	1976	24	1631	16	1693	11	1797	4
		1906	18	1875	16	1976	26	1969	25	546	15	1975	6			521	29	1920	16	1915	13	1976	4
		1972	10	*1980	18			1963	26	1950	15	1954	9					1946	21	1907	14	1960	29
						526	20	1976	28	1896	16	1978	17					1972	23	1951	18	1953	12
						1293	20			1976	17	1290	27					1932	26	1536	24		
						1960	21-29			1966	19							1939	27	1939	27		
						1935	30	79 A.D.	24		24							1828	28	1531	26		
						1970	31	1883	26		26							1908	28				
								1886	31		31							1974	28				
								1968	31		31							1703	30				

*Mt. St. Helens initially gave warning of its potential on March 27, 1980, only six days after the Earth crossed the Sun's equator and went into opposite sunspot polarity. Cumulative effects then occurred within the volcano causing it to erupt on May 18, 1980. Over a four year period, Mt. St. Helens has produced activity within a 30-day period of March 21st — the day the Earth crosses the Sun's equator.

TORNADO AND HURRICANE "DISASTERS" PLACED IN MONTHLY ORDER — DATES ARE HIGHLY SIGNIFICANT!

MARCH		APRIL		MAY		JUNE		JULY		AUGUST		SEPTEMBER		OCTOBER		NOVEMBER		DECEMBER		JANUARY		FEBRUARY		
YEAR	DAY(S)	YEAR	DAY(S)	YEAR	DAY(S)	YEAR	DAY(S)	YEAR	DAY(S)	YEAR	DAY(S)	YEAR	DAY(S)	YEAR	DAY(S)	YEAR	DAY(S)	YEAR	DAY(S)	YEAR	DAY(S)	YEAR	DAY(S)	
t	1925 18	t	1936 5-6	t	1896 27	h	1953 9	h	1967 9	h	1969 17-19	h	1930 3	h	1976 1	h	1971 1	h	1974 25				t	1884 19
t	1932 21-22	t	1965 11	t	1953 11	h	1882 5			h	1955 18-19	h	1928 12-17	h	1963 3-8	h	1970 13							
t	1952 21-22			h	1963 28-29	h	1957 27-28			h	1893 22-30	h	1947 15-19	h	1881 8	h	1977 21							
				h	1965 11-12	h	1972 16-23			h	1900 27	h	1974 19-20	h	1960 10/31	h	1703 26-27							
										h	1954 31	h	1934 21	h	1954 12-16	h								
										h	1954 21	h	1938 21	h	1942 16	h								
										h	1955 22-28	h	1955 22-28	h	1935 21	h								
										h	1954 26	h	1959 27-28	h	1959 27-28	h								
										h	1959 26-27	h	1876 31	h	1876 31	h								
										h	1958 27-28	h	1949 31-2	h	1949 31-2	h								

Both Hurricanes in Pakistan!

t = TORNADO h = HURRICANE

FIGURE 53-D

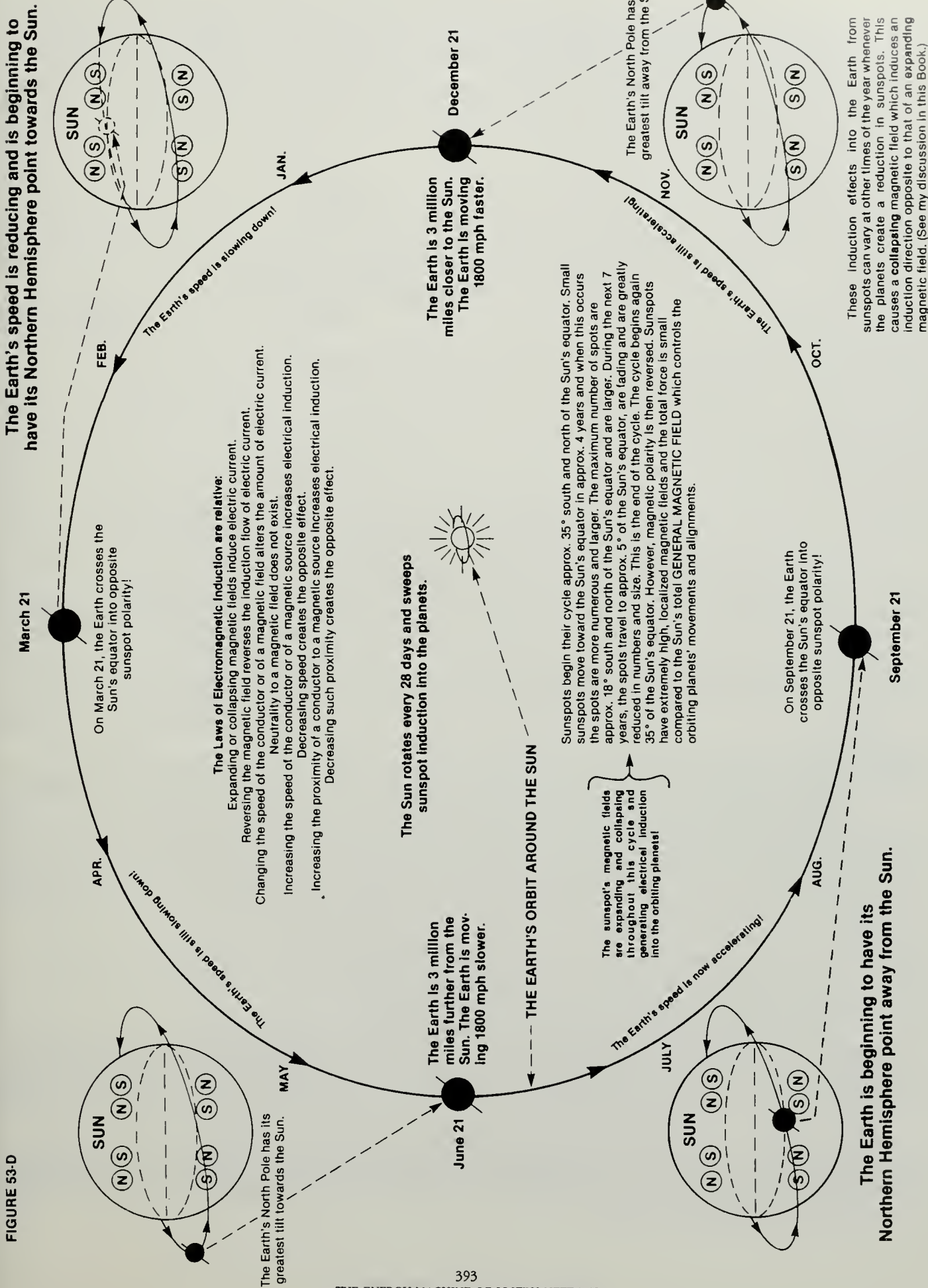

- (F) The Drawing below provides an example of Mercury and Jupiter on one side of the Sun's equator and Venus, Mars, Saturn, Uranus, Neptune, Pluto, and the Earth on the opposite side of the Sun's equator in May, 1988. [See the prediction of Nostradamus.] The Earth crosses past the Sun's equator, *i.e.*, the Earth crosses through the plane of the sun's equator into opposite sunspot position at about 16° where the greatest induction activity occurs.

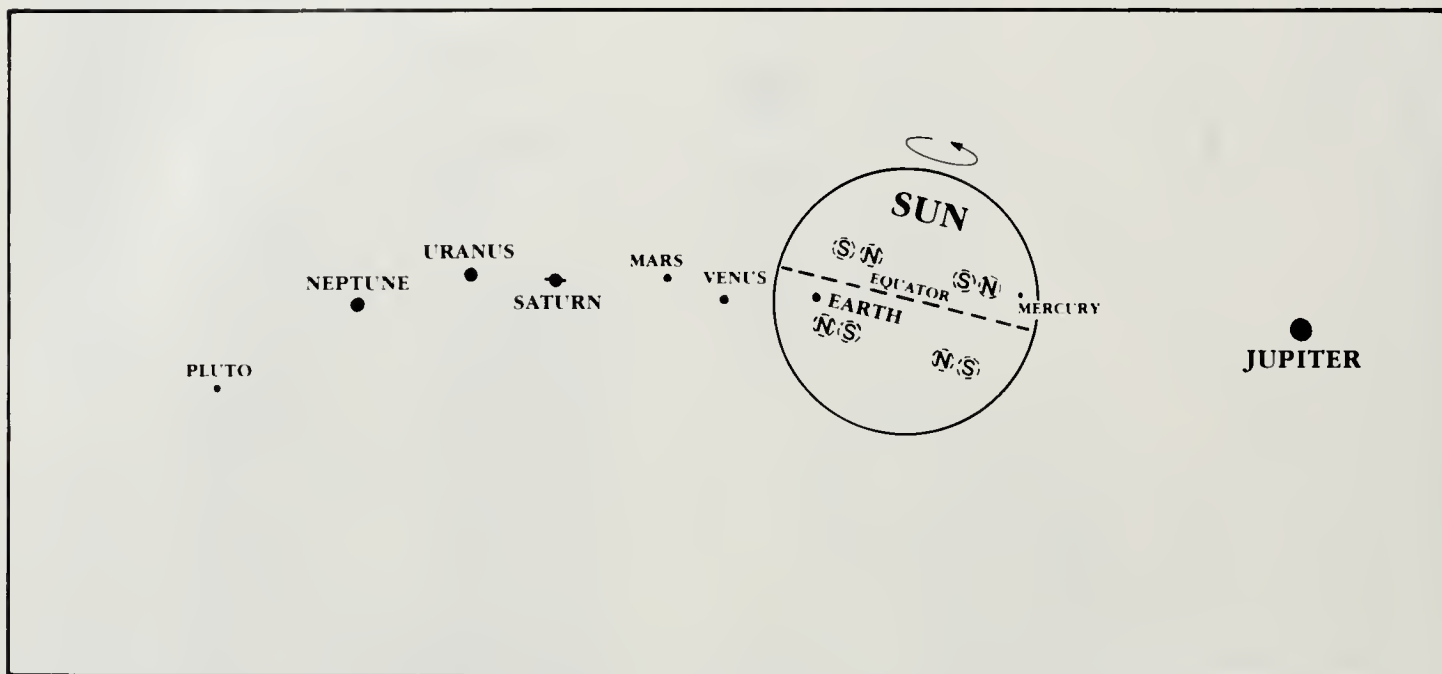

☉ represents sunspots attempting to form and then attempting to fade out. Such action results in expanding and collapsing electromagnetic fields. [See (A) through (E) above.]

Saturn and Uranus will still be in close alignment in May, 1988, but on the opposite side of the Sun from Jupiter. Jupiter and Mercury will be reducing sunspots on that side of the Sun's equator and inducing sunspots on the other side of the Sun's equator. **This alignment last occurred 288,708 years ago!**

Venus, Mars, Uranus, Saturn, Neptune, and Earth are reducing sunspots on the other side of the Sun at their side of the Sun's equator and inducing sunspots on the other side of the Sun's equator. The Sun rotates those areas within 14 days by 180° thereby compounding the expanding and collapsing electromagnetic fields from the Sun.

- (G) In drawing (F) above, Saturn and Uranus come into alignment on February 14, 1988 with Jupiter being in near vicinity of its closest point to the Sun. This position was computed for me by Ralph Hartwell of New Orleans, Louisiana and last occurred 288,708 years ago! The effects are made worse by Mercury being in harmony with Jupiter's induction and Venus, Mars, Neptune, and Earth being in harmony with the induction of Saturn and Uranus in the month of May, 1988. Observe how I will show Jupiter's significance to earthquakes, etc., and how consistently Jupiter has demonstrated a connection with earthquakes, etc. Combine this fact with my teachings and the fact of Saturn and Uranus' alignment at the pertinent time of the major effect of Jupiter — such alignment last occurred 288,708 years ago. You should expect that the normal effects of Jupiter's relationship to earthquakes, etc., will be greatly amplified.

The results of planetary arrangement in (F) above will result in obvious sunspot numbers being on the low side, but it will have devastating effects upon the Earth.

I simply quote a few past examples when sunspot numbers were low:

Major earthquakes occurred in **1812, 1822, 1833, 1843, (1855-1857), 1866-1868, (1878-1879), (1888-1891), (1901-1903), (1913-1914), (1923-1924), (1933-1934), (1944-1945), (1963-1964)**. This record is like clockwork for 152 years! It is obvious to me that these dates are a reflection of Jupiter's orbit which takes 11.86 years to travel around the Sun. Jupiter stays in the vicinity of its closest point to the Sun for a couple of years. (Jupiter's speed is faster at this point, its magnetic field is closer to the Sun, and its induction greater into the Sun.)

Jupiter's closest point to the Sun was July, 1987, and Jupiter will still be in that vicinity on May, 1988. (Please note that if you multiply Jupiter's orbit 11.86×2 orbits and add same to 1964, this equals 1987.2 which falls close to July 1987 — the time Jupiter was at its closest point to the Sun.) The facts will show the record above will confirm havoc and devastation in 1988!

FACT 32: Examine what occurred in Alaska on March 27, 1984:

Just after the Earth on March 21 had crossed the Sun's equator into opposite sunspot (potential) induction at low (obvious) sunspot numbers, there was a great earthquake estimated at 8.3 to 8.6 on the Richter scale. (An 8.6 is double the magnitude of 8.3.) The result of that one great quake gives the thinking mind an idea of what could happen. [*Except now you should expect much worse!*] An estimated 75 percent of Alaska's commerce and industry lay in ruins and thousands of individuals were homeless. That quake was one of the mightiest of this century and generated an amount of energy equivalent to 12,000 Hiroshima-type atomic bombs. A tsunami (calling it a tidal wave is not correct) moved at more than 400 miles per hour across the Pacific and affected Canada, Oregon, California, Hawaii, and the shores of Japan 4,000 miles from their source.

What also concerns me is the fact that just from the initial shock of the Alaskan earthquake, **the entire Earth vibrated like a great, silent gong for two weeks.** The initial seismic waves were so powerful that buildings swayed as far South as Seattle, Washington, lifted the ground beneath Houston, Texas as much as four inches, and lifted the ground in Cape Kennedy, Florida, two and one-half inches.

Now imagine several such great earthquakes happening at different parts of the Earth in such a way as to cause an amplification of vibrations. This could then produce stresses in other parts of the Earth where the waves intersected or met in a detrimental arrangement.

Consider the problem of large sinkholes already occurring in Florida from ground water draining. That same problem of removing excessive amounts of ground water has now occurred in many areas of this nation, but has not yet caused a major problem. QUESTION: What is likely to happen if the facts of the paragraph above occurred?

Consider also that a quake may occur where it is normally not expected. There are several such records in U.S. history. EXAMPLE: In 1811-1812 an earthquake struck the Midwest on February 7th and was so powerful that it rattled windows and chandeliers in Washington, D.C., stopped pendulum clocks in Charleston, South Carolina, rang church bells in Richmond, Virginia, woke people in Pittsburgh, Pennsylvania, and in nearby Kentucky "the ground rose and fell in successive furrows like the ruffled waters of a lake. The earth waved like a field of corn before a breeze."

These areas were thinly populated in 1812. Such an earthquake almost anywhere in the United States would now cause great havoc.

FACT 33: Return to the great quake of 1964. [Watch the clockwork record of 152 years become the clockwork record of 164 years!], and add 11.86 years, the orbit of Jupiter = 1975.86 at which time in Tangshan, China, earthquake watchers were perplexed by activity in that area which some seismologists thought was harmless because the area had been inactive for so long.

On July 28, 1976 the area in China was struck hard by a Great Earthquake calculated at 8 on the Richter Scale, and then 16 hours later an aftershock of 7.4 on the Richter Scale struck. [Stay alert!] *Western experts estimated that as many as three quarters of a million people died.*

Seismologists later agreed that the horror was one of a series of major earthquakes that occurred in 1976 along an arc from Italy through Uzbekistan in the Soviet Union to the New Hebrides Islands North of Australia. Central America was also hit. (Now watch the clockwork record of 164 years become the clockwork record of 176 years in 1988!)

Now add the 11.86 years of Jupiter's orbit to 1976 = 1987.86 years which is slightly after Jupiter's closest point to the Sun in July, 1987. Look at the warnings we have already received since September of this year, 1987. Going forward to May, 1988, will be about the same warning time as China's 1976 Great Earthquake. [California, Los Angeles, San Francisco, and Utah] You can expect more than in 1976 because we now have an extremely dangerous situation! This situation last occurred 288,708 years ago!

Whoever you are and wherever you are, when your area is hit by one of these tragic events, I send you my fighting spirit — react swiftly and instinctively with the mind that God has given you. God helps those who help themselves and others.

Move to open spaces instantly! Watch for islands of land that do not break up and then move there. Watch for buildings, etc., that can fall in the area which you select. Solid, high ground usually fares better than low, soft ground. Cliff areas are very dangerous since they may collapse. Expect rockslides and avalanches crashing down from the sides of mountains.

Roadways will collapse and bridges will crumble; houses and buildings will collapse, the ground will split open, the ground will collapse in at varying spots and rise in others; some spots will be almost unscathed, fires will erupt, water may gush over you or flying objects and other various "Challenges" will attempt to devastate you. Do not give up! Your mind must fire with tremendous speed.

Sense, anticipate, and analyze each changing moment and more and act instantly. You must run the gauntlet for approximately four minutes! And throughout and afterwards, be aware of your insignificance in the great turmoil of material things, but your importance through the love of God and therein lies your strength. Thank God and help those who are in

need! Prepare for aftershocks for several days, and if close to the Coast or even up a river, expect tsunami and watch for potential volcanoes in the area.

FACT 34: At this point I attach a map of the Ring of Fire and other danger areas of the world for earthquakes and volcanic eruptions. Tsunami will also occur. Damaging storms will occur. I do not expect the whole map to be hit directly, but at unusually greater than normal quantity and intensity. The whole Earth may feel the effects by some means. I expect an earthquake or earthquakes of a minimum of 8.6 on the Richter Scale, but more probably it will be 9 or more! (An 8.6 is the greatest earthquake ever recorded on the Richter Scale.) Also remember that volcanic eruptions and tsunami often occur with great earthquakes.

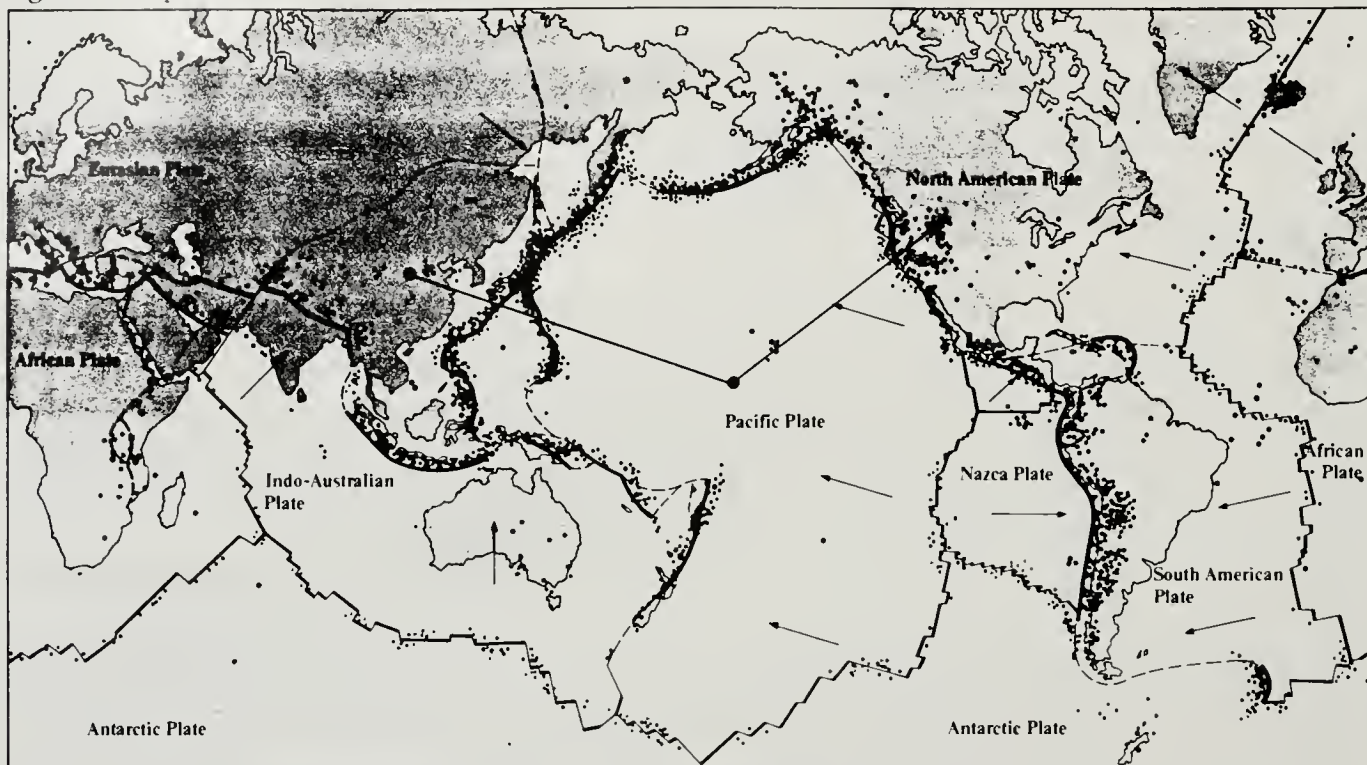

- | | | |
|-------------------|-------------------------------------------|-----------------------------------|
| continental crust | spreading rift offset by transform faults | subduction zone |
| volcanoes | uncertain plate boundary | collision zones within continents |
| earthquake zone | movement of plates | oceanic crust |

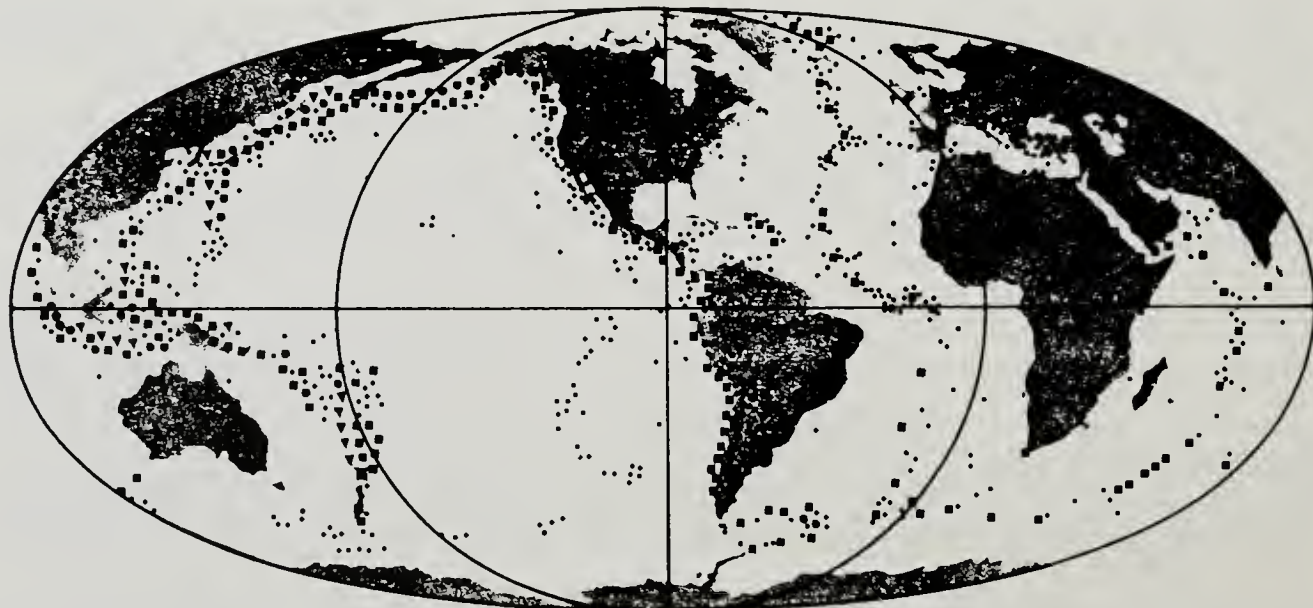

World map of earthquakes shows that most epicenters are concentrated around the Pacific, central Asia, the Mediterranean, and the mid-oceanic ridges. All the larger symbols represent sites of major earthquakes that have occurred during the last 70 years.

- Normal
- Major superficial
- Major intermediate
- ▲ Major deep

FACT 35: People being informed in the event of an earthquake is of extreme importance, and even a few minutes of notice can save thousands of lives as was demonstrated in Winkow, China on February 4, 1975. Notice was given for people to leave their homes to prepare for an earthquake several hours prior to the event and in an area of three million people where an earthquake of this magnitude can be expected to bring death to tens of thousands, the estimated toll was only about 300. The rural communities fell into ruins and almost 90% of area buildings were severely damaged or destroyed.

It is imperative that people and the nations of this world are all taught the proper procedures.

Again, I stress the grave importance of every caring newsperson to see that this information is disseminated on a worldwide basis! **REASON:** Simple. The Reagan Administration has for nearly eight years sought to keep secret and discredit my Pioneering Invention and all of its associated varied scientific information, which includes this present vital information. [Refer also to my last **PRESS RELEASE** of September, 1987.]

There are other individuals in Congress who fight my Pioneering work such as Congressman **ROBERT KASTENMEIER** from Wisconsin, who has consistently fought my work for Humanity. Ironically, it was Kastenmeier who, as the Chairman of the Subcommittee on Courts, Civil Liberties, and the Administration of Justice, was — on October 22, 1987 — the guest speaker at the American Intellectual Property Law Association in Washington, D.C. At this meeting, Kastenmeier deliberately spoke of my work and implied that I had **DROPPED ALL MY EFFORTS IN THE COURTS, ETC.**, to receive a patent on my Energy Invention.

What Kastenmeier says is a deliberate and premeditated lie! **QUESTION:** Why do you think these individuals who are supposed to represent Justice and the People so conspire to discredit and/or steal my Pioneering Technology? **ANSWER:** Power and Money! **[I urge you to contact Robert Kastenmeier at (202) 225-2906, U.S. House of Representatives, Washington, D.C. 20515, and assure him that I will continue to fight for Justice and the expansion of my Pioneering Technology for the benefit of Humanity.]**

In their eagerness to perform injustice, such individuals have created a situation which will soon cost hundreds of thousands of lives — possibly millions of lives.

The recent, heart-moving situation of the little girl in the abandoned Texas well will be multiplied thousands of times except with tragic endings.

These evil individuals who have plotted against God's gift through me to Humanity will not now likely admit their guilt by endorsing the humane warnings I give.

This is why caring members of the press must warn the world!

FACT 36: I recommend that the people of this nation and the world take this potentially tragic situation and do all we can to build love and harmony throughout the World.

Let's examine some of the positive possibilities:

- (A) All cities and towns located in potentially dangerous areas depicted on the map in **FACT 32** must take immediate, positive action as though you knew for sure that your area would experience one or more of these events.
- (B) Positive action should include keeping all heavy-duty equipment in an area free from falling material, fire, and possible tsunami.
- (C) Portable, military-style hospitals should be established in the same areas as described in (B) above and be disbursed in various areas throughout, for example, a single city.
- (D) Food, portable generators, chain saws, and water should be stored in ways to meet the requirements of (B) above. People should also secure a safe place in an area of their yard and in their home all heavy objects should be removed from shelves and walls. Have several fire extinguishers handy.
- (E) Portable radio communication systems should be established in different areas.
- (F) All possible and practical precautions should be effected near waterfronts that would reduce the damage in the event of tsunami.
- (G) Portable housing should be stored in accordance with (B) above.
- (H) All military installations, chemical companies, weapon storage areas, nuclear reactors, missiles, etc., must meet requirements of (B) above. Some may need to be moved or temporarily closed. Great missile explosions could occur! Great radiation leaks, great germ or chemical warfare leaks could occur in storage areas!
- (I) People should choose at least one safe area in the immediate vicinity of their home. Universities in the area can design and calculate what should be done in a given terrain or area. People should have long, strong ropes in their cars and homes to pull people up and out of holes, etc.
- (J) It has already been proven that many animals sense in advance of one of these events occurring. Therefore, people with pets should know and observe their own pet's reactions. Cities themselves should locate reputable, dependable

individuals with animals in different areas of the city and have them call on a daily basis to a given number to report if their animals have acted normally or abnormally. This information would be observed on a daily basis and compiled on a graph. At the first statistical sign of danger, the city should declare a danger warning and urge people to leave dangerous areas in an orderly fashion and stay away until no sign of danger is found.

- (K) Whenever Universities and/or laboratories detect danger signs of vibrations, changing magnetic fields, etc., then the same danger warning should be provided.
- (L) States that have dangerous areas should have supplies, work equipment, shelters and hospital equipment, food, etc., placed at readiness in safe areas of the state to be moved to any area at a moment's notice.
- (M) People in every state should buy and store goods to send to an area at a moment's notice. Each city should establish a number that could be called by local people for what materials and the amount of materials needed to be shipped to the disaster area(s). Volunteers in those safer areas should form their organizations *now* to begin orderly and efficient disbursements to the needed areas. Radio and TV shows should be brought into this organization *NOW*.
- (N) Every country around the world should be ready to help every other country that experiences devastating events.

This is a time when all people of the world can literally demonstrate that they love and care for one another and are willing to prepare for one another's well-being, knowing that some will have great hurt and heartache in 1988.

I have no doubt that God expects us to use our minds and our hearts and it would not surprise me one bit to see the World's damage decrease by the intervention of God depending upon how we all lovingly try to help one another. The opposite will occur if we demonstrate that we do not care or refuse to use our minds.

- (O) ***I warn the whole world!*** Refer back to FACT 33 — the China Quake in 1976 was part of a string of quakes across numerous countries and areas. 1988 will be much worse than 1976! Every area of the world that is presently receiving unusual, small, warning quakes should prepare for a possible major quake in 1988 [esp. cautious of May, 1988]. I know that areas are already receiving these type warnings that I have not heard about because the newsmedia are being told that they are not significant quakes.

These warnings are of extreme significance! Utah, Japan, Hawaii, etc. are prime examples.

- (P) I especially caution the coastal California area, and even more specifically the Los Angeles and San Francisco areas.

I believe it very possible that Los Angeles and the California coastal area received a warning from God in September/October 1987, because the quake was strong enough to get the attention of the people of Los Angeles but with minimum loss of life.

Observe that in the Nostradamus film Orson Wells as narrator states that San Francisco or Los Angeles ("the New City" as Nostradamus calls it) are very likely candidates for the Great Earthquake of May, 1988 which will destroy the city(ies). Observe that even before knowing of Nostradamus, I had predicted cumulative effects of induction into the Earth with the devastation of earthquakes, etc., more likely to occur in April and May. Observe also that these symptoms match those in FACT 33 of China which would follow in time to an earthquake around May, 1988.

I sincerely recommend to all people of the Los Angeles and San Francisco areas to take a vacation if possible in May, 1988. In good conscience, I recommend that visitors be extremely cautious about visiting Los Angeles and San Francisco in May, 1988. I do so because I most definitely believe that God gave Nostradamus a great gift to benefit Humanity.

However, in accordance with my own talents God has given me, **I recommend that the World be diligent from now through all of 1988 and probably into or through 1989.**

If you are awakened at night by or see **great sheets of unnatural light across the sky**, prepare yourself and loved ones instantly for an earthquake. Get outdoors to your safe area!

To put it simply, I quote what I have taught my young son since he could understand me: "*If you use your Mind, good things will happen! And if you don't use your mind, bad things will happen!*"

History is full of events where so-called learned or political people ignored the warnings of nature (God) and advised and even demanded the inhabitants of a threatened area to remain there. This resulted in great loss of life.

III. Economics (FACT 37)

I feel very certain that the events to come represent a message from God to all the inhabitants of the World, because God gave Nostradamus the gift to warn us at this time and God gave me the gift to mentally think and give factual evidence which coincides with Nostradamus' warning to us. God gave all of us a Mind, and God expects us to use it. To do other than this is an affront to God.

God clearly shows his mercy in trying to consistently warn us to follow God's direction and think and act in such a way that proves that we love and care about one another's well-being. I say again, this potential tragedy can be turned into a very positive event for all Humanity if we start preparing now on a worldwide basis for each other's well-being and then follow through with an action of love.

I say again: *"All caring members of the press must disseminate this information throughout the world!"*

FACT 37: I say again: *"God has directed me in a Warm and Loving Way to run for the Presidency of the United States. Will you rally around me?"*

The major problem of the world is that we do not care about or love one another.

The recent stock market crash of October 19, 1987 exemplifies what I say. On this day fear took over, the market fell, and greed had initially made it rise so high. If people simply do not let fear set in, the economy will be all right. If people react to fear then they doom themselves towards a Depression.

Another shocking fact that further exemplifies what I say: I simply quote from pages 254 and 257 of my book, "THE ENERGY MACHINE OF JOSEPH NEWMAN." On page 254 is a graph that shocked me terribly as a young man during a college economics course. This graph literally made me ashamed to be part of a human race that demonstrated such stupidity — [I define "stupid" as having the facts in front of you and ignoring them.] — that it would graph its mistakes and then repeat them over and over and over. The graph represents an economy that gives the people Hope and slaps them down with misery over and over and over again.

The Republican and Democratic Parties demonstrate this greed philosophy which pulls the People of this nation apart!

The Party which I have formed to seek the Presidency of the United States is called the Truth and Action Party. This Party will strive to have Management and the Labor force both recognize that in "Truth" neither can function efficiently if the other does not function efficiently.

The following graph demonstrates why the world pulls itself apart: FEAR and GREED — both of which are an affront to God! This plays havoc with the well-being of Humanity! And this graph does not only affect the economy, but the whole attitude of people across the world towards one another.

The following is from page 257 of my book and shows what the World can be if we use our minds God has given us.

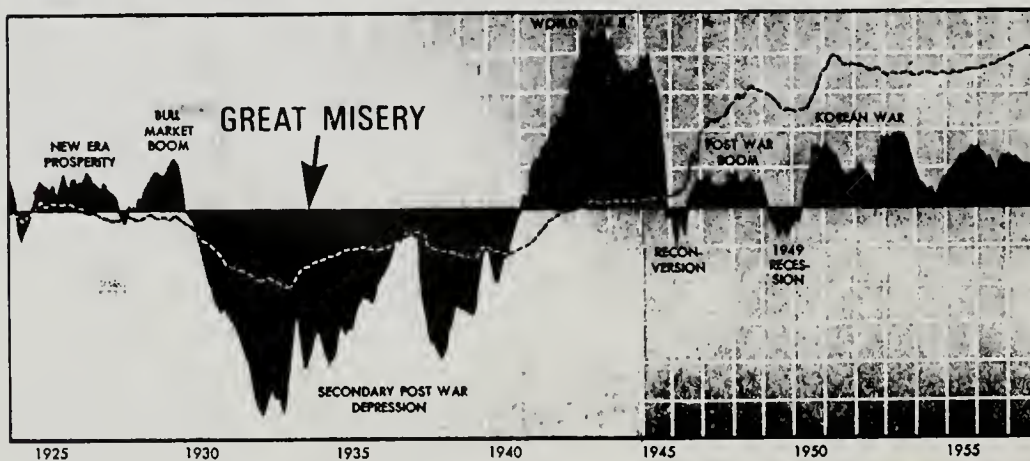
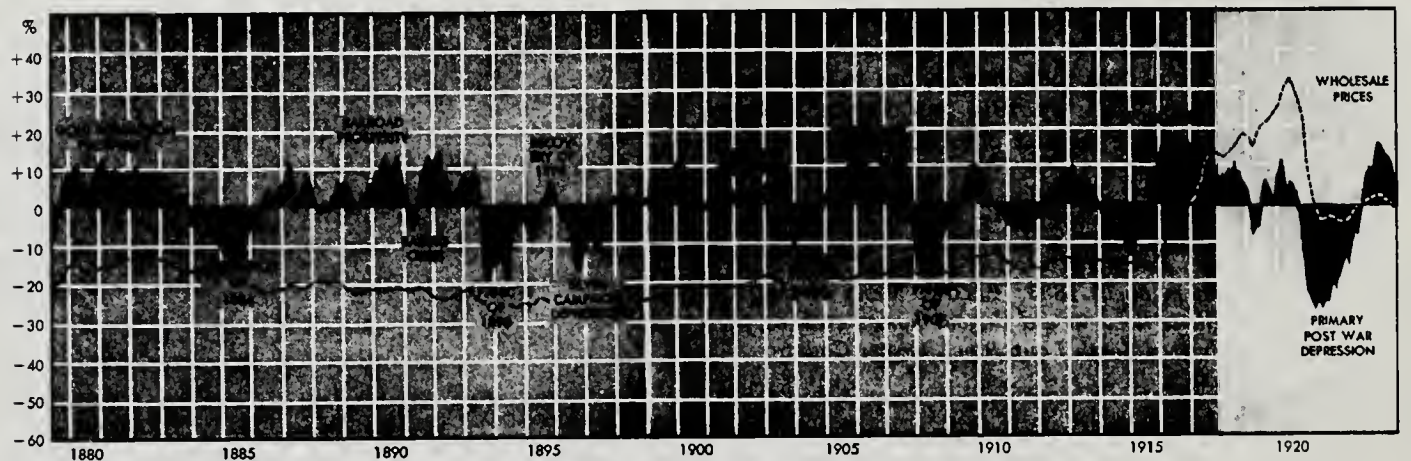
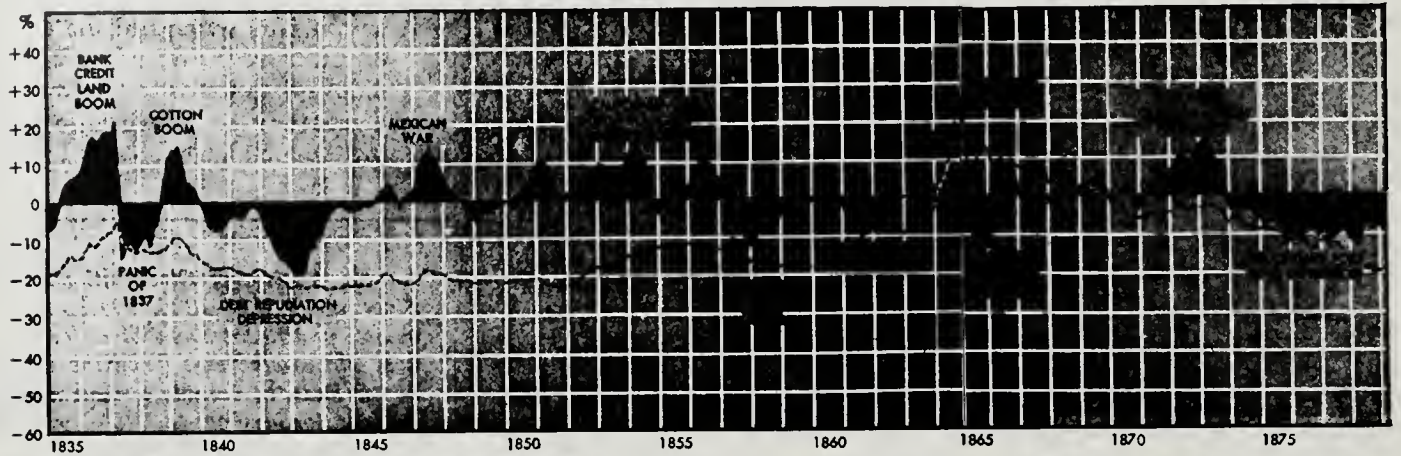
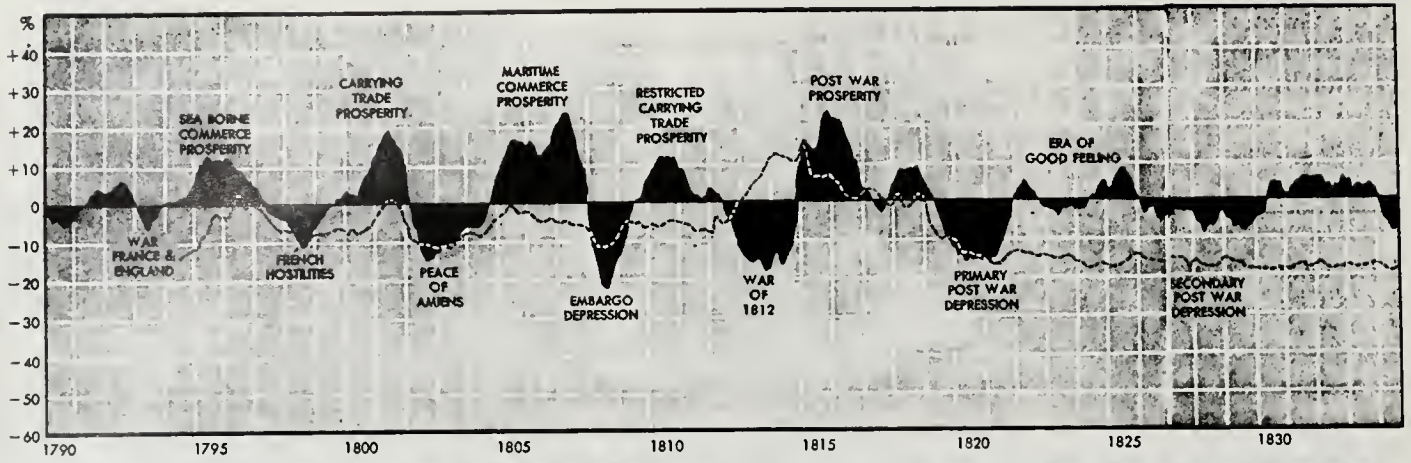

American business activity, shown in solid black and indicated by the scale at the left, has been subject to wide fluctuations from the long-term trend. Changes in wholesale commodity prices are suggested by the dashed line.

Reprinted from "An Economic History of the United States" by Gilbert C. Fite and Jim E. Reese, Boston, Houghton Mifflin Co., 1959.

the *whole* picture. The positive actions I propose will naturally decrease costs and dramatically increase the well-being of all people.

And from the management/employer perspective: If worker employment is high, then there is an extremely large consumer population willing and desirous of purchasing your products.

Moreover, as the working hours of the "employee/ workers" decrease, then these employee/workers have more leisure time available. Such leisure time generates additional demand for more products, services, new companies, and greater employment.

Sound and "thinking" Economics requires that realistic safeguards proposed by the general public, company managers, and employees be established. If properly prevented, "Greed" and "Fear" will not occur. *At the same time, however, incentive must not only be maintained but stimulated!* It is an observational fact that animals perform far more efficiently when an incentive reward is provided for their efforts. For human beings, this is even more true.

Companies must strive to increase financial profit via increased production and sales, *not* by price increases.

Similarly, workers must strive to obtain more products and services *not* by salary increases but via increased production which *lowers* the cost of such products and services.

If a company enjoys an increased demand for its products or services, that company must *not* proceed to irresponsibly raise its prices, if at all.

In essence, top-level company management, top-level employee personnel, politicians, other responsible individuals, and especially *you* — the "voters" — must unite to think, question, and solve problems *together*. If such is done, then the Positive and Efficient Economic program I have described *will occur*.

The following statement is a *Fact*: *If "Fear" and "Greed" are replaced with "Truthful Thinking," Questioning, and Action, then the realistic results of the Economics which I teach will produce the following graph:*

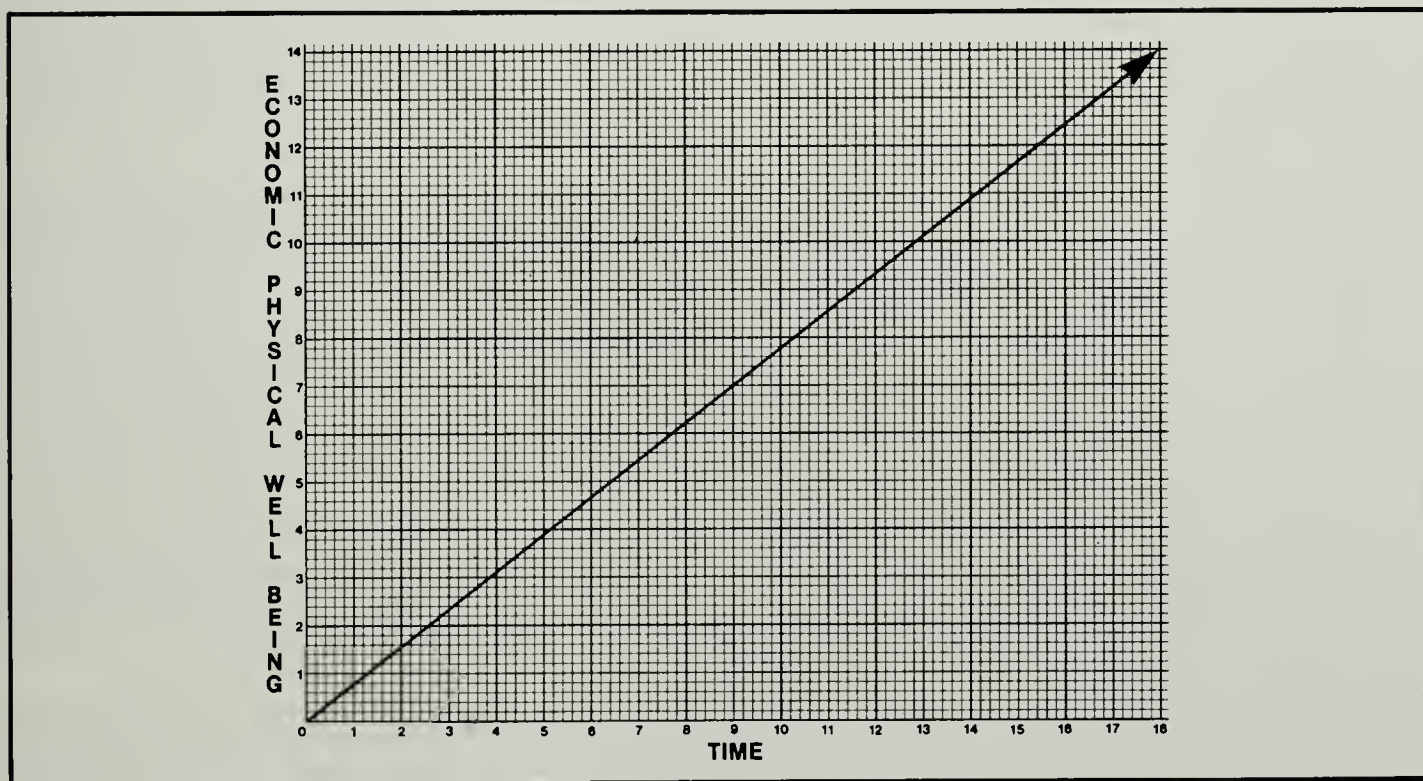

What I have been discussing is Positive Economic Action that is compatible with the Revolutionary Energy Invention to which I have devoted many years of my life. Such Positive Economic Action will enable Space Travel to become an efficient and exciting reality. I am also speaking of the beginning of positive hopes and dreams for our young children and those future generations who look to us for a "smoother road through life!" The historical facts prove that in Economics we most definitely "reap what we sow."

That which is required is actually quite simple. What is required is that we *truthfully* "Question, Think and Act." The achievement of what I have described also requires *that we care for one another* which is the functional essence of *Goodness*. Moreover, the simplicity of what is required is mirrored in the "twinkling eyes" of our ever-questioning children. Such simplicity only demands that we creatively utilize the "Birthright" of our own "Questioning Mind," which has previously remained as a *Sleeping, Majestic Lion*.

I urge this "Majestic Lion" to *awaken!* *And the world will be changed most beneficially.*

The following Chapter will discuss an area requiring urgent attention and constructive change for the benefit of you, the "People."

IV. All Religions who praise God must praise one another. The present position in which religions condemn one another is our greatest threat to world peace.

FACT 38: I say again: my essence and Nostradamus' essence was and is a gift from God to Humanity. I say again: God has directed me in a Warm and Loving Way to run for President of the United States. Will you rally around me?

The events that will occur in 1988 are only an example of the almost total destruction that will occur from a third World War by 1999 if we do not change — events that presently unfold like a horror movie in front of us. I urge you to see the film of Nostradamus! The tragedies which will occur in 1988 may well change the balance of power. If several missile sites or atomic storage areas are exploded as a result of damage, those areas will be annihilated and other areas will also be negatively affected.

From Nostradamus' film I quote the warning that God gave to Christians and to non-believers:

“All the believers of Christianity and the non-believers shall quake for a number of years.”

It is obvious to me that the knowledge and mind which God has given me is a gift God offers Humanity. I am merely a vessel, which I humbly and dedicatedly accept. All that I have written in my book, “THE ENERGY MACHINE OF JOSEPH NEWMAN” and do now write in this PRESS RELEASE is a gift of direction by God towards the 1000 years of peace described by Nostradamus. God's gift of mercy can be accepted now by the World. We can also destroy most life and material things on this Earth beforehand by 1999 — or we can change now and follow God's direction to love one another worldwide and grow into the 1000 years of peace in a loving way. God's Way.

These things will happen! God has said it via all the major religions of the world without providing an exact date. But more than 400 years ago, God through Nostradamus gave the date of 1999. God gives the same message again to the World through the mere man that I am. Through his great mercy God also warns us at this time and gives us the opportunity to still change and love one another. By so conducting ourselves, the destruction will not occur.

CHRISTIANS — take seriously the warning God has given you (written above) through Nostradamus who had a Jewish and Christian background. I was raised as a strict Baptist and I am positive that the Christian's selfish attitude is an affront to God's Mercy given to Christians 2,000 years ago. I ask all non-believers to look and observe what God has directed me to write and teach. God is real and merciful and the essence of all Truth. Watch the events unfold and see that they match what Nostradamus' gift from God predicted and now match the God-given gift to me and which I put forth. God will show and give you his love if you truthfully reach for it with your own mind.

MOSLEMS — I want you to know that I know that God loves you, as God loves the Jewish and Christian Communities and all God's people. I understand the cause of the hatred now building between the United States and parts of the Land of Mohammed. I, myself, have experienced the evil of my own Government. I ask that you keep the love of God close to your hearts and do not let hatred blind you in the event the People of this nation elect me as their President. War will devastate most people of the world. [See the film concerning Nostradamus.]

I am well aware that the selfish attitudes of the religion to which I was raised offends you. Please be advised that because it offended me so greatly I quit believing in God at one time due to the smallness of man. In his great mercy, God answered my prayer and only through God's direct mercy to me, do I know God. But I now know God with all the essence of my being and live to serve God and all Humanity.

I can only serve God or Humanity through Truth, Courage, and Action.

Accordingly, it is imperative that I get the Christians (as I was rigidly raised) to congratulate, love, and accept all religions who worship and follow God's laws. The present attitude of Christians that everyone must go through their beliefs to reach God is one of the greatest threats to destruction of most life on this Earth.

Again, the smallness of man does this! — not God. **God wants love and peace between all his people.** THIS is the “Revelation” to the purpose of Nostradamus' Gift from God. Christians will quake for a number of years if you do not obey God rather than man. See the film on Nostradamus. God speaks to you through it and through the gifts God has given me.

If you choose to blindly dismiss God's gift through me to Humanity, and if you really believe that, then you will not have any fear concerning yourself or your loved ones in dangerous areas of the Earth for the year 1988.

When the devastation occurs — you will *then* look to God and not man!

To all people who believe in God, especially Christians — in the balance of this PRESS RELEASE I speak to you. I now write the prayer that I pray to God at this instant of writing: "God, come into my being and give me the words to say that will shame your people as your words shamed me when I doubted your Mercy and Greatness and Realness because of seeing words of contradictions in the Christian Bible."

For the reader, I quote from pge 247 of my book, "THE ENERGY MACHINE OF JOSEPH NEWMAN," God's mental command to me that shamed me: "Get Up And Do What You Do Best!" I immediately got up and checked the essence of all religious teachings and to my great pleasure I found God's Great Mercy and Truth to all Humanity. All religions teach the same essence of God's Message of Goodness!

If you are troubled by the following facts, then you the reader must do as God has told me to do. Rise up and use your mind [God's greatest gift to you!] and check out the facts for yourself. Do not blindly believe me for I am only a mere human. Likewise, do not blindly believe any other claimed teacher of God's Word.

Check out the Facts for yourself, to do other than that is an affront by you to the Great Gift of the Mind that God has given you!

For those who worship and blindly follow man and thereby make a mockery of the Great Gift of the Mind that God has given you — you will be shocked, dismayed and your belief in God made doubtful by the following facts.

For those who worship God and are willing to use your mind responsibly as God expects you to : [God's greatest proof to you of God's realness.] You will be made angry by the fact that this important information has been deliberately and premeditatedly withheld from you, and you will see that facts are gathered — in the present — in the past — in your own life — and in the future which draw you closer to God and factually document God's Realness to others who exist now and for others who follow.

May these facts instill in you God's hurt and disappointment and God's wrath to change the belittlement done to God and the injustice put upon his People and you.

FACT: Most Christians believe the Bible to literally be the word of God or Christ.

FACT: Man wrote, argued, debated, and decided what and how the Bible would be written and then decided to keep the magnitude of these facts from the people who sought God through the Church leaders. The following facts will prove this so because Christian Bibles do not have the true and accurate details of these facts in the front of or anywhere else in the Bible. Moreover, Church leaders do not honestly and openly teach the magnitude of these facts.

The following quote is from page 547 of the first edition of the 1768 Brittanica Encyclopedia:

"Before our Savior's time, there was no other Greek version of the Old Testament, besides that which went under the name of the Septuagint: But after the establishment of Christianity, some authors undertook new translations, under pretense of making them more conformable to the Hebrew text. The first who performed this design was the Jewish profelyte Aquila, of the city of Synope in Poctus, disciple to Rabbi Akiba, who put it in execution the twelfth year of the emperor Adrian, A.D. 128. St. Epiplahnus pretends, that being excommunicated after his conversion, for addicting himself to judicial astrology, he set about this version out of hatred to the Christians, and with a wicked design of corrupting the passages of the prophets relating to Jesus Christ. St. Jerom says, his version is made word for word, and with too scrupulous a nicety.

"The second Greek version after the Septuagint is that of Symmachus, a Samaritan by birth, who first turned Jew, then Christian, and at last Ebionite. He composed it, according to Epiphanius, in the reign of the emperor Severus. His version was more free than the rest; for he applied himself chiefly to the sense, without translating word for word; wherefore his version comes nearer the Septuagint than that of Quila. The third Greek version is that of Theodotion of Ephesus. It is said he was a disciple of Marcion, and that, having had some difference with those of his sect, he turned Jew. The version of this author was the best of the three, because he kept a just medium between Aquila and Symmachus, not confining himself so servilely to the letter as the first did, nor wandering so far from it as the second did.

"There were, besides these, three other Greek versions, whose authors are unknown."

The next quote comes from Page 549 of the same 1768 encyclopedia after a divulging history of human impact and input in the development of the Bible:

"Since the face of affairs in Europe has been changed, and so many different monarchs erected upon the ruins of the Roman empire, the Latin tongue has been decreased greatly into disuse; whence has arisen a necessity in translating the Bible into the respective language of every people; and this has produced as many different versions of the scriptures as the modern languages and as many different nations professing the different religions."

Returning to page 545 of the same 1768 encyclopedia provides more evidence of the problem:

“Some of the ancient fathers, on no other foundation than that fabulous and apocryphal book, the second book of Esdras, pretend, that the scriptures were entirely lost and destroyed at the Babylonish captivity, and that Ezra restored them all again by divine revelation.”

I next quote sentences (not out of context) from Britannica Encyclopedia 1969, Book 3, Pages 570 through 587 concerning the Bible. Use your mind. Check these facts yourself — Go to your Library!

Page 573 under the title, New Testament:

“The setting of the New Testament within the Christian community is one factor that makes a biography of Jesus or a history of the 1st Century church difficult or impossible ... There is less Historical information in the New Testament than in the Old, and many historical facts about the Church in the 1st Century therefore, must be arrived at by inference from a statement in one of the Gospels or Epistles ...”

Page 575 under the title Canon of the Old Testament:

“The question as to which books belong in the Old Testament is complicated by the history of the Old Testament in both Judaism and Christianity. Not only is the use of the word “canon” as a designation for an authoritative list of sacred books a rather late phenomenon, even the idea of a fixed and final list came about after a long evolution.”

Page 575 under the title Canon and Text:

“... it is evident that the Bible is a series of pictures, some of them simple portraits, others more subtle sketches, still others highly abstract symbols. For that reason the determination of what does or does not belong in the Bible is not an easy task ... The translation of this variety of language and literature into a new language likewise creates difficulties ...”

“When a Protestant examines a Roman Catholic version of the Bible, he notices the presence of certain books that do not appear in his own Bible ... In addition when almost any reader examines a new translation of the Bible, he discovers that some well-known passages are missing from it ...”

Page 577 under the title Canon of the New Testament:

“Christians usually have to think twice to realize that there was once a time when the Christian Bible did not contain both the Old and the New Testament. New Testament statements such as II Tim. iii, 16, “All scripture is inspired by God,” are predicated of what came later to be called the Old Testament; so are many of the references to “Scripture” in the early Fathers. Only gradually did Christians find it necessary to add a second collection of sacred books as the “New” Testament alongside the Old.”

Page 577 under the Title, Canon and Tradition:

“Before any books were included in the canon of the New Testament, or even composed, the Christian Church used the Old Testament as its Bible; but it possessed also its tradition of memory about Jesus Christ. This tradition lies behind and is presupposed throughout the New Testament.”

I now point out the known fact of Psychology: that give a short story to one of ten people in a room and ask them to repeat as close as possible the story from one to the other until the tenth person is told the story and then ask the tenth person to repeat what he or she was told. Fact — the tenth person always tells a different or changed version of the story than what the first person told.

Now back to the Title-Canon and Tradition excerpt on page 578:

“The task of sifting through the writings of the early church and of identifying this apostolic witness occupied Christians well into the 4th Century. Eusebius (q.v.) suggested the following division of these writings:

(1) Some were acknowledged almost universally as part of the New Testament; (2) others were disputed but finally accepted; (3) still others were considered more or less seriously but eventually rejected.

Page 578 under the title Disputed Books:

“The Epistle to the Hebrews belongs to this category. It seems to have been accepted in the eastern section of the church but disputed in the west, for it does not appear in the Muratorian canon and is also questioned by other writers. Although I Peter, is almost universally acknowledged, it is not listed in that category because of its absence from the Muratorian catalogue. II Peter, on the other hand, was questioned by many fathers who accepted I Peter. The Epistle of Jude appears in the Muratorian canon but was rejected elsewhere. II John and III John sometimes were included with I John as one book, but they did not receive the universal support that it did. The Book of Revelation probably was the object of more antagonism than any other of the books eventually canonized. The Montanist movement made apocalyptic literature suspect in the orthodox church, and some writers did not believe that the same man had written the Gospel of John and Revelation.”

Page 578 under the title Text of the New Testament:

"1. Evidence — Textual criticism of the New Testament becomes necessary because of the thousands of variations in the existing manuscripts and versions ... The main source of the evidence and of the variations are manuscripts of the New Testament, dating from the 2nd to the 10th Century or even later. In the process of copying, these manuscripts underwent the revisions that necessitate textual criticism. Some of these revisions were unintentional, as the scribe skipped a word or a line or as he mistook one character for another. Other revisions came from the desire of the scribe to harmonize the text of one Gospel with another or of one Testament with the other, or from his pious wish to "correct" or clarify the text at another point. But now that variations in the text exist, collation of the manuscripts is a difficult task."

Page 580 under the title English:

"Despite the many English translations of the Bible in whole or in part undertaken during the middle ages, it is not until the 16th Century that the history of the English Bible as we know it today actually begins.

"Such a new translation was provided by the Authorized or King James version of 1611. While the Authorized version has never lacked critics, it has so embedded itself in the religious and literary history of the English-speaking peoples that its secure place has been challenged only by revisions of it, not by replacements for it. Such revisions came in the (British) Revised version of 1881-85, followed by the American Standard version of 1901. This latter was more drastically revised in the Revised Standard version (New Testament 1946, Old Testament 1952, Apocrypha, 1957), which was accorded more general acceptance among U.S. Protestants than the American Standard had received."

Throughout history, Christian Church leaders have on many occasions dictated tragic injustice to the people who did not follow their small mindedness and submit to their dictatorship attitudes. Just a few examples follow:

The burning of Joan of Arc, House arrest till death of Galileo, and the actual torture and death of other good intentioned scientists or individuals.

For centuries there was a rigid impedance to the progress of science in general. It was taught that diseases were an Act of God and therefore preventive shots should not be given. And the old belief that "if God had wanted man to fly then God would have given man wings," and on, and on.

There occurred the deliberate persecution of individuals who did not believe in God exactly to their dictates. Individuals were even burned to death as witches without even the shadow of a **trial** by Justice. There were those who endorsed the slavery of black people and confirmed the false myth that women had no rights.

The facts of History of many church leaders' injustice to the Human Race is shockingly long. The fact of the shining light to this terrible truth is highlighted in the founding of this country. "*Separation of Church and State.*" Why? **REASON:** Simple. The Founding Fathers had experienced and knew from History that Church leaders in general when placed in control serve injustice — not justice. **QUESTION:** Who were and are church leaders? They were and are mere men with biases and prejudices and whom many do not truly understand or appreciate God's Great Mercy and Truth.

Such is still true to this very day and their prejudiced and biased influence still exists and wrongly affects the lives of good people — yet these church leaders are still mere men. Do not look to any Human — me or any other — for God's Truth and Mercy. Use the mind that God has given you. God expects you to use it and in so doing you will find God, I guarantee you. Look to God and God's examples as given us in life! However, if you look mainly to man to find God, then it is very likely you will never know God. You will only know man's biases and prejudices.

In the discussion of God in my book, "THE ENERGY MACHINE OF JOSEPH NEWMAN," I stated that there are mistakes and contradictions made in the Christian Bible as well as in other Bibles. I did not, however, recommend that you throw away the whole Bible any more than a textbook that had mistakes in it. Even though there are some mistakes there are also truths in the Bible as well as there are truths in textbooks that have mistakes.

By the facts, it is obvious that the Bible was not written immediately but was remembered, handed down, and written by different individuals who interpreted, argued, and modified. This is exemplified by the fact that when I was a young boy raised as a strict Baptist and baptized when I was eight years old, Jesus was taught without question to be the Son of God and that it was God who was always praised. Jesus was taught to be one who suffered for our sins, but suffered this through the loving mercy of God. It was God who was supreme. [There are millions of other individuals living today who are taught the same information.]

When I now scan TV programs, I see across the country preaching that does not praise God, but praises Jesus as being God. This proves how man has interpreted and drastically changed the meaning of scriptures in my lifetime. At this time I am only 51 years of age. If this trend continues, I can predict the possibility from personally observing people who follow today's Christian teachings that the name God will not even be used or taught — only the name Jesus will be used. Many

young and old people already sense or believe this because they have been so taught. Such is exemplified by such statements as "Thank you Jesus" instead of "Thank you God" when something good happens in their lives.

Such a trend results in many Christian teachers promoting an Anti-God theology. Although they probably do not realize this fact, it is nevertheless true.

My point is further exemplified by the fact that, as a result of the older Christian teachings, even our money states, "In God We Trust" and our legal oaths are sworn to God. The word Jesus is not mentioned in either case.

Because many of today's religious leaders preach that Jesus *is* God (which I feel is not true), I am sure that the Devil smiles and vigorously laughs at these results. Such results automatically maintain and places a greater gap and greater possibility of war between all Christians, Jews, Followers of Mohammed, and other religions. Jews and Mohammedans readily admit that Jesus was a teacher of God to the People reached by Jesus' testimony. The reader should be aware of the fact that even Christian teachings admit that all who obey God will become a Son of God.

As a young man in my twenties I personally quit believing in God because I felt such great mercy for Humanity. I most certainly did not believe a Merciful God would send a God-obedient Jew, Moslem, or any other individual to Hell simply because they did not know Jesus.

As a young man, I looked straight up to the sky, challenged what I had been rigidly taught by man, and stated that because of the mercy that I felt for Humanity — not only was I willing to give my life, but that I was willing to give my Soul.

My simple prayer was: "God, if you exist, please make me know it relative to the mind you have given me."

God mercifully answered my prayer more exactly than I even imagined — see the Chapter on God in my book, "THE ENERGY MACHINE OF JOSEPH NEWMAN."

Prior to Jesus, the Gentiles were considered pagans and supposedly only reached God through Jewish instruction and/or institution.

How sad it is that Christians (as I was raised) fail to comprehend God's great mercy to the Human Race. By example of God's mercy to the Gentiles to which Peter was referring for the benefit of the Jewish population so that they could understand that Gentiles could be saved without Jewish consent or intervention through believing in Jesus being the Son and Gift of God for any and all that chose that particular covenant of God.

Even more sad is the fact that Christians now fail to remember God's great mercy to them and attempt to restrict and confine God's Universal Mercy to reaching God only through their instruction and/or institution. [Quite obviously, by such biased and restricted "mercy," then all intelligent life on other planets in other solar systems — of which I am certain that there are many — are doomed to Hell in addition to the members of all other religions who pray and obey God.]

I, myself, would most definitely be doomed to Hell, because I cannot or never will submit to an unjust God. However, I have absolutely no worry of this happening because God has revealed himself to me in an absolute way and no individual's opinion can change God's Great Truth and Mercy.

Anyone who has mercy would know the above to be unjust if intelligent life on other planets of the Universe worship and obey God. Therefore, to infer that God is less merciful than any human on this Earth is Blasphemy.

For an example of my strong feelings concerning God's Universal Mercy, I quote from page 59 of a nine-page article from the May, 1987 DISCOVER entitled "JOE NEWMAN: DOES HIS AMAZING MOTOR REALLY WORK?"

This quote refers to the fact that Joseph Newman was turned down from appearing on Pat Robertson's 700 CLUB TV Show:

"According to Melillo, Newman simply said that although he believed in God, he didn't follow Jesus Christ. 'His honesty cost him \$40 million,' says Melillo."

Interestingly enough, Pat Robertson now runs for President of the United States and yet he was unwilling to permit an individual to appear on his TV Show — an inventor who had an Energy Invention that the inventor had repeatedly stated could do more to bring World Peace than all the Kings, Queens, and Politicians who have ever lived. I was barred from the Pat Robertson Show because I would not blindly follow Pat Robertson's religious beliefs. Yet, at the same time, Pat Robertson claims that he cares about helping people who have a tremendous need for such an invention.

For those people who see the Truth in the facts that I have stated and are rightly concerned about how to interpret the Bible, I recommend the following:

Do not worry about the nit-picking points in the Bible, but realize the essence of what God says in the Bible and the essence of what God teaches around the world that we should all love and care, feel for, and have respect for one another. Observe that the major problem of this Earth today is that people and teachers have centered on little nit-picking things within religious teachings and in so doing have virtually lost the true essence and concept of what God teaches universally. I quote again Peter's truthful statement of which I speak, "Then Peter opened his mouth, and said, 'Of a truth I perceive

that God is no respecter of persons: But in every nation he that feareth him and worketh righteousness, is accepted with him. " ACTS 10:34, 35.

Do these things along with what I have already said at the beginning of this article addressed to religious people, and you will make the pathway of those who follow us towards God so much easier, clearer, and absolute. If you now let your mind at this instant reach to God truthfully, humbly, and honestly to give you a feeling of his Truth and Mercy, you will sense a truth of which I speak to you because God's Truth is universal and any God-thinking-individual can perceive God's mercy and truth.

Concerning the love that every Christian feels towards Jesus, you have an obligation to maintain that love exactly as individuals in other religions have the same obligation to the individual that God directed and who gave testimony of God to them. Keep in mind that any mistakes made in the Bible were not made by Jesus being directed by God. Likewise, mistakes in other Bibles were not made by their holy leaders who were inspired by God. Any and all mistakes are and were made by Man.

I am also aware that there are many individuals — when they read these facts — will know his Truth instantly because they themselves have felt ill at ease about the very facts I have discussed because of the Truth that God has placed within them in spite of the way they were taught.

After writing all of this material, I was given a book on Thomas Paine. It is obvious to me that Thomas Paine was such a truth-seeking individual and had the very strong feelings of which I speak as is evident in his book *THE AGE OF REASON* written in 1794. His writing contains a lot of cynicism, despair, and repulsive-reaction-disbelief because there was not a rigid or normal dictate of honesty of Science for full disclosure of the facts relative to the history of religions. In great detail, Mr. Paine describes that some claims appear to be false, contradictory, and poorly put forth. Therefore, Thomas Paine rejected all of the claimed history of religions. [Again, I state that there are truths in the Bible — the essence is God's love in Humanity and God's desire for Humanity to love one another and God.]

However, Thomas Paine strongly believed in one God for all People. To quote Thomas Paine:

"It is only in the Creation (of the Universe) that all our ideas and conceptions of a Word of God can unite. The Creation speaks a universal language, independently of human speech or human language, multiplied and various as they be. It is an every-existing original, which every man can read. It cannot be forged; it cannot be counterfeited; it cannot be lost; it cannot be altered; it cannot be suppressed. It does not depend upon the will of man whether it shall be published or not; it publishes itself from one end of the Earth to the other. It preaches to all nations and to all worlds; and this Word of God reveals to man all that is necessary for man to know of God.

"Do we want to contemplate His power? We see it in the immensity of the creation. Do we want to contemplate His wisdom? We see it in the unchangeable order by which the incomprehensible whole is governed. Do we want to contemplate His munificence? We see it in the abundance with which He fills the earth. Do we want to contemplate His mercy? We see it in His not withholding that abundance even from the unthankful. In fine, do we want to know what God is? Search not the book called the Scripture, which any human hand might make, but the Scripture called the creation."

The above quote by Thomas Paine came from the very heart of his Soul. However, the facts and its essence of the history of God's direction to the Human Race should be documented immensely truthfully of the past, the present, and the future so that no other Human will feel as Thomas Paine when presented the existing history of religion in that particular instant of time.

There will probably be some, possible even many Church leaders, who will attempt to dictate to the public that this information should not be read. As I have stated in my book, "*THE ENERGY MACHINE OF JOSEPH NEWMAN*," God does not hide from questions. PROOF: God gave you a Mind! Does not your mind instantly scream out at you that God expects you to use your mind? How do you do that? Simple — just as I have written in the concrete walkway leading to the door of my workshop: "**QUESTION AND THINK = TRUTH.**"

Only mere men and women make statements claiming them to be fact and then in the same instant hide in the dark corners of deceit, and by the threat and intimidation of the unjust wrath of their interpretation of God tell you not to question the so-called facts which they have given you. Instantly, you should always be extremely doubtful by such a reaction from any individual, because you can be sure of one thing: God does not speak through them!

Throughout this PRESS RELEASE it is my purpose by God's guidance to outsmart the Devil and the evil he places in mankind by bringing together all people who worship God independent of each other through one religion — the religion of God's Mercy — and show them factually that God's love can pull them together in a loving entity of one.

As I have consistently stated in my book, "*THE ENERGY MACHINE OF JOSEPH NEWMAN*," then as now, it has been my only purpose in life to bring love, peace, and happiness to all on this Earth; a gift by my God to all people who believe in God or wish to believe in God since we are one and the same in our true Goal — To Reach God.

V. Conclusion

In no way does the Mercy of God take away from or belittle the exceptional sacrifice Jesus made for Christians! Nor does God's Mercy take away from or belittle those whom God's Spirit directed in all those religions that teach to Praise and Obey God.

It is obvious that the Devil is wise enough to know from the facts that everything is going the way he wishes and totally opposite to what God wants because the Devil has had the religions of the world killing and hating and talking against one another for over 2,000 years. And now he has the World traveling at a fast speed towards terrible devastation to most life on this Earth within the next 12 years.

I quote again the prayer that I have in my book: "*God, give me the knowledge and wisdom to unite all people of this Earth to you and not the first one, no not the first one, from you.*"

The manner in which religious people make a mockery of God's Great Gift of the Mind from God — by totally closing it and then following whatever man teaches them simply because they were raised that way — truly dumbfounds me.

Religions try to cling to man's interpretations of God — an interpretation given by man initially more than 1,000 years ago. On numerous historical occasions since then, God has shown his presence through individuals of the time at hand — in their lifetime — and the close-mindedness of the people would not see God's light and direction.

At this time, God has shown his presence and realness so factually and thoroughly through factual experiences covering more than 400 years ago to this present day. God does so with such clarity that it amazes my scientific mind. The facts still unfold at a rapid rate — facts that prove God's realness, direction, and instructions. QUESTION: Will you use your mind and see God's Truth and Mercy to Humanity and God's dire warning to the Human Race?

Be advised that I despise political games and that I would have never run for President of the United States except that God so directed me.

When I called a News and Public Conference in New Orleans to announce that I am running for President, only a handful of reporters and public attended.

When I mailed a PRESS RELEASE to 12,000 people including most of the newsmedia, only two handfuls of replies and very little news coverage was given to the fact that I am running for President.

When I have to fight vigorously and constantly against the evil of our Government to get the Energy Invention (God's Gift to Humanity) out to the People of the World, the people of the world have talked much and wished me well, but the fact is that the people have not taken deliberate action to help.

These facts sadden me, and I am not ashamed to state that during the last several weeks since God has made me aware of these facts, I have had tears flow from my eyes because of the horror I know will fall upon Humanity if the people fail to take action.

I know that most people are basically good because most people will have tears come to their eyes if they see a sad movie.

However, I now speak to you with my fighting spirit! Most people "*run their mouths*" but do not take responsible action according to the true God-given dictates of the heart of the mind.

Such a position makes those people "*cop-outs!*" I scream at you — unless you get some guts — and do what you know God, not man, would have you do, then horror that most of you cannot even comprehend is at this very moment ever-increasingly bearing down upon you and your loved ones.

Make no mistake — I fight for you! Not for me! I have offered my God-given gifts to Humanity in my book, "THE ENERGY MACHINE OF JOSEPH NEWMAN," and when I spoke in Mobile, Alabama at the NATIONAL INTERTEL MEETING [composed of individuals with an I.Q. higher than 99% of the People] on Saturday, July 18, 1987, I demonstrated an electromagnetic space device. I made a vow that within 20 years of using my technology I had developed, that I would leave this Earth. I was so offended by the uncaring and greedy actions of Humanity that I did not wish to live here or even be buried on this Earth.

God has now informed me that this is not what God wishes me to do.

Make no mistake — I laugh at death! I do so because I have fought unceasingly all my adult life for the well-being of the Human Race and I know with the absoluteness that only God can give that I will have the Peace and the Loving environment that is the very essence of my being within the presence of God when I meet death.

But the fact is that most people will be petrified when the horror hits Humanity, if the people do not take the positive action God has directed the People to take.

The caring and mercy God has placed within me sheds tears at your misfortune. This is why I send Humanity my fighting spirit when the horror starts.

I offer myself freely to be a vessel to God's Mercy and Guidance by way of Peace and God's Bright Light of Truth and Mercy into the year 2000 A.D. and 1000 years of Peace and Happiness in God's Love which can extend past that time so long as we hold to God's Truth and Mercy.

The alternative is a most saddening thought. As I have no doubt whatsoever, this alternative will occur within the next 12 years if we do not change immediately. Blindly denying these facts that God has directed me to put forth will not stop the terrible destruction. Just the opposite — it will help **guarantee** the terrible destruction.

I truthfully and sincerely tell all the people of this world that I believe that God has planned and directed my life and has directed me to put forth these Truths, *i.e.*, THE ENERGY MACHINE OF JOSEPH NEWMAN. And God has commanded me in a Warm and Loving Way to run for the Presidency of the United States.

I ask again, will you rally around me?

Wishing to serve God and Humanity,



Joseph Westley Newman

October 27, 1987

P.S. If you believe in what I have written, you must take positive and immediate action. See to it that this information is quickly spread across the Earth

(A) Funds are needed for the campaign. [I realize that there are hundreds of hustlers across the world that use scare tactics and then ask for money. I say, again, I am doing this for you — not for me. If you do not want me to be able to perform, then do not send a dime!]

(B) Organizers of a nationwide political machine are needed.

(C) Establish Presidential Campaign Organizations for the TRUTH AND ACTION PARTY in your area.

(D) Volunteers for all aspects of this campaign are needed.

(E) To stress the importance of this energy technology for Humanity, I urge you and your loved ones to have an orderly march on Washington, D.C.

Please fill out and return to

JOSEPH NEWMAN FOR PRESIDENT COMMITTEE

Route 1, Box 52 Lucedale, MS 39452

Dear Joe:

CONGRATULATIONS! It's high time someone fights back against the unjust political machines, and I WANT TO HELP!

Here's how:

Here is my 1987 contribution to help you get matching funds from the government dollar-for-dollar up to \$250. I enclose:
 \$ _____ \$1,000 \$500 \$250 \$100 \$50 \$20

I also enclose \$ _____ for _____ copies of the **SUPERCONDUCTIVITY/PRESIDENTIAL PRESS RELEASE**. [1-4 copies, \$1.50 each; 5-49 copies, \$1.25 each; 50+ copies, \$1.00 each.]

I also enclose \$ _____ for _____ copies of the **MAJOR EARTHQUAKE PREDICTED PRESS RELEASE**. [1-4 copies, \$1.50 each; 5-49 copies, \$1.25 each; 50+ copies, \$1.00 each.]

I want to participate in your campaign. Please put me in contact with others of like mind in my area. My telephone number is: (____) _____-_____. (It would help if you'd write on a separate sheet of paper how you feel you can be of help.)

Name _____

If your contribution is \$250 or more, we are required by federal law to request the following:

Address _____

Occupation _____

City _____ State _____ Zip _____

Employer _____

Paid for by the Joseph Newman for President Committee

Since the end of 1987, the facts of devastation and/or drastic change around the world — in China, Europe, Russia, Central and South America, the United States, Canada, etc. — only prove the TRUTH of the Essence of what you have just read within the pages of the Blue-Covered Press Release.

During the last two years I issued many additional Press Releases which contained the same warnings in addition to what you have just read. The George County Times of Lucedale, Mississippi printed most of these Press Releases! As I issued these Press Releases more and more of the news media and the so-called friends and loved ones, etc., continued to turn away from me and my Life's Work for Humanity and my obedience to God.

I compliment my good friend Evan Soulé as I did in the Acknowledgements in the front of this book, because he has not only stuck by and with me, but Evan has also seen the Facts and has understood that God speaks to Humanity at this time. In fact, I have asked Evan to write you of his feelings about this subject at this time — (the following insertion was written by Evan Soulé):

It was over five years ago that Joseph Newman related to me the significance of the number "14" and how this special number served as a message from God to him. (The reader should refer to page 245 of this book for Joe's discussion of the importance of the number "14".)

Joe urged me to also do what he did — to ask of God: "God, if you exist, make me know it relative to the mind you have provided me." So I tried what Joe recommended and repeatedly asked this simple question of God. The very first time I quietly concentrated with this question deep in my mind, only one single word came almost immediately to me mind: "TREES".

Each time I asked this question — and I asked this simple question again and again over a three month period — I received the same answer and nothing more: "TREES". As a result I began to consider what this single word really meant. In the ensuing five years it has become quite apparent. This single, special message — TREES — which was directed to me has come to signify the forthcoming danger to all humanity on this planet if we

continue to abuse the ecosystem and destroy the rain forests of South America, the beautiful pine forests of the West Coast, and the magnificent, oxygen-producing trees of Canada.

Five years ago there was very little specifically said about the importance of TREES. Now, however, within the past six months, even LIFE MAGAZINE devoted an entire issue to "TREES"! And, of course, we are now continually hearing of the importance of recycling and of the risks to endangered species to the repeated attacks upon the remaining stands of forests in the Pacific Northwest.

Because the word "TREES" was my special message five years ago, I will do what I can to sensitize Humanity to the importance, beauty, and necessity of ensuring the survival of this world's great forests — without which the very survival of Humanity would be at stake.

These special messages to myself and to Joe must be heeded by Humanity if we are to enjoy a millennium and more of Peace. If ignored, then — as Joe has repeatedly stated — Humanity will suffer the consequences!

The following information was written by Joseph Newman —

I have produced a 30-minute VHS film containing a summation of pertinent, factual Proof that God warns the World and that God has chosen me at this time to warn all Peoples of this Earth to "Love One Another" or this very decade God will do exactly as God warns in Isaiah, Chapter 10 of the Old Testament.

This VHS tape demonstrates factual proof that all seven major religions of the world teach that a person inspired by God will appear near the year 2000 A.D. (now) and will teach Love, Truth and Peace to all Peoples of this Earth.

This VHS tape can be obtained by sending \$21.00 (includes freight/postage) by check or money order to Joseph Newman Publishing Company, Route 1, Box 52, Lucedale, Mississippi 39452.

And as if to exemplify what I have just written in the above pages, this very Sunday evening (as I now write these words) CBS National News reported that numerous tornadoes ripped across

Indiana and Ohio inflicting serious damage!

It is now Sunday, July 1, 1990 as I sit alone, except for the presence of God, in the backwoods of Mississippi. I have just returned from a business trip to Utah to secure a means for manufacturing capital for the Pioneering Technology I have disclosed in this book.

I feel very positive that you the People will be able to purchase the stock of the company which will be formed for the purpose of producing the technology within the near future.

Back in 1984 — immediately after I was featured on the CBS TV National News Report featuring the energy machine technology — I received a conference telephone call. The speaker on the telephone did not identify himself or his group, but stated the following:

“Mr. Newman, we have checked you out and we know you are dedicated. You name your price and we will match it. And you deserve to take the rest of your life off.” I instantly replied, “No, thank you — it is not for sale. But let me make you an offer: you tell me how you will get behind this Technology and produce it at a fair and reasonable price and I will be glad to work out a License Agreement with you.”

The individuals on the conference call were not interested, and within three days of that call, a young man on Wall Street who was trying to raise production and research capital for me telephoned to my house and sounded very upset. He specifically said that the “word” has been put out on Wall Street not to deal with Joseph Newman.

This book stands as a testament of the persecution by the corrupt U.S. Government and the Power Brokers against myself as a result of my total commitment to have the energy machine Technology reach out to the Peoples of the World.

The corrupt pressures that have opposed this Technology is further exemplified by the fact that in just the past two weeks Mike Barkley of Paul, Idaho called me to report that he would have to give up on trying to manufacture the Technology because the State of Idaho was already starting to harass him about any investments, etc., for produc-

tion of technology, as well as pressures from other sources.

And the corruption doesn't end here! Further evidence of the continuing corrupt pressures to stifle this Technology is blatantly demonstrated by the recent tactics of the corrupt U.S. Government against myself. The following is a copy of my Petition to the U.S. Supreme Court:

No. _____

IN THE
SUPREME COURT OF THE UNITED STATES
OCTOBER TERM, 1989

JOSEPH W. NEWMAN

PETITIONER

VS.

DONALD J. QUIGG, Commissioner
of Patents & Trademarks - RESPONDENT

PETITION FOR WRIT OF CERTIORARI
TO THE UNITED STATES COURT OF APPEALS
FOR THE FEDERAL CIRCUIT

PETITION FOR WRIT OF CERTIORARI

JOSEPH W. NEWMAN
pro se
RT. 1, BOX 52
LUCEDALE, MISSISSIPPI 39452
(601) 947-7147

QUESTION PRESENTED

A. DOES EMPLOYEES OF THE U.S. PATENT & TRADEMARK OFFICE HAVE THE RIGHT TO PREMEDITATEDLY AND DELIBERATELY VIOLATE THE CONSTITUTION OF THE UNITED STATES OF AMERICA AND THE VERY ESSENCE AND ONLY PURPOSE OF THE EXISTENCE OF THE FOUNDING OF SAID OFFICE BY CONGRESS AS EXPLICITLY STATED IN SECITON 8 OF ARTICLE I OF SAID CONSTITUTION BY DELIBERATELY WITHHOLDING THE EXCLUSIVE RIGHT TO AN INVENTOR OF THE FRUITS OF LABOR OF A PIONEERING DISCOVERY AND COMPOUNDING SAID VIOLATION BY DELIBERATELY AND PREMEDITATEDLY VIOLATING ARTICLES VII AND VIII OF THE BILL OF RIGHTS OF THE CONSTITUION OF THE UNITED STATES OF AMERICA BY DENYING INVENTOR TRIAL BY JURY AND SIMULTANEOUSLY INFLICTING EXCESSIVE FINES AND UNUSUAL PUNISHMENT OF EXTREME MONETARY LOSS AND EXPENSES AND YEARS OF MENTAL INJUSTICE TO SAID INVENTOR?

PARTIES

NAMES OF ALL PARTIES APPEAR IN THE CAPTION OF THE CASE.

(i)

TABLE OF CONTENTS

<u>QUESTION PRESENTED</u>	<u>PAGE</u>
A. DOES EMPLOYEES OF THE U.S. PATENT & TRADEMARK OFFICE HAVE THE RIGHT TO PREMEDITATEDLY AND DELIBERATELY VIOLATE THE CONSTITUTION OF THE UNITED STATES OF AMERICA AND THE VERY ESSENCE AND ONLY PURPOSE OF THE EXISTENCE OF THE FOUNDING OF SAID OFFICE BY CONGRESS AS EXPLICITLY STATED IN SECTION 8 OF ARTICLE I OF SAID CONSTITUTION BY DELIBERATELY WITHHOLDING THE EXCLUSIVE RIGHT TO AN INVENTOR OF THE FRUITS OF LABOR OF A PIONEERING DISCOVERY AND COMPOUNDING SAID VIOLATION BY DELIBERATELY AND PREMEDITATEDLY VIOLATING ARTICLES VII AND VIII OF THE BILL OF RIGHTS OF THE CONSTITUTION OF THE UNITED STATES OF AMERICA BY DENYING INVENTOR TRIAL BY JURY AND SIMULTANEOUSLY INFLECTING EXCESSIVE FINES AND UNUSUAL PUNISHMENT OF EXTREME MONETARY LOSS AND EXPENSES AND YEARS OF MENTAL INJUSTICE TO SAID INVENTOR?	(i)

PARTIES

NAMES OF ALL PARTIES APPEAR IN THE CAPTION OF THE CASE	(i)
--------------------------------------------------------	-----

Table of Authorities Cited

I. <u>OPINION BELOW</u>	1
II. <u>JURISDICTION</u>	2
III. <u>CONSTITUTIONAL PROVISIONS</u>	2
A. CONSTITUTIONAL PROVISIONS	3

(ii)

IV. <u>STATEMENT OF FACTS</u>	3
V. <u>REASONS FOR GRANTING WRIT</u>	17
VI. <u>CONCLUSION</u>	20

TABLE OF AUTHORITIES

<u>CASES</u>	<u>PAGE</u>
<u>U.S. Verses Adams</u>	
383 U.S. 39, 15L. Ed 2d 572, 86S. CT. 708 (1966)	17

RULES AND STATUTES

62 Stat. 928, 28 U.S.C. §1254 and 28 U.S.C. §2101	2
Article III of the Constitution of the United States	2
Rule 20, 28 U.S.C. §1651(a)	2
Federal Rule of Civil Procedure 53(e)(2)	2

OTHER SOURCES

Section 8 of Article I of the United States Constitution	2
Seventh Amendment of the United States Constitution	3
Eighth Amendment of the United States Constitution	3

PETITION FOR A WRIT OF CERTIORARI
TO THE UNITED STATES COURT OF APPEALS
FOR THE FEDERAL CIRCUIT

Petitioner, JOSEPH W. NEWMAN, respectfully prays that a writ of certiorari issue to review the judgment and opinion of the United States Court of Appeals for the Federal Circuit entered in the above-entitled cause on July 5, 1989 and modified on September 29, 1989.

L

OPINION BELOW

The opinion and its modification of the Court of Appeals is attached as Appendix A and B. The District Court's constitutional violation order of awarding \$100,000.00 plus costs against me is attached as Appendix C.

- 1 -

II

JURISDICTION

The opinion of the Court of Appeals for the Federal Circuit was filed in July 5, 1989 and rehearing requested by Respondent was denied in part and granted in part on September 29, 1989. The jurisdiction of this Court is invoked pursuant to 62 Stat. 928, 28 U.S.C. §1254, 28 U.S.C. §2101, Article III of the Constitution of the United States, Rule 20, 28 U.S.C. §1651(a), Federal Rule of Civil Procedure 53(e)(2). And extension of time to January 27, 1990, was granted by this Court to file the petition. Informal was timely filed and this Document in proper form was thereafter timely filed.

III

CONSTITUTIONAL PROVISIONS

Section 8 of Article I of the United States Constitution provides:

The Congress shall have Power...

“To promote the Progress of Science and useful Arts; by securing for limited times to Authors and Inventors the exclusive Right to their respective Writings and Discoveries.”

- 2 -

Article VII of Bill of Rights of the United States

Constitution provides:

“In suits at common law, where the value in controversy shall exceed twenty dollars, the right of trial by jury shall be preserved, and no fact tried by a jury shall be otherwise re-examined in any court of the United States than according to the rules of the common law.”

Article VIII of Bill of Rights of the United States

Constitution provides:

“Excessive bail shall not be required, nor excessive fines imposed, nor cruel and unusual punishments inflicted.”

IV.

STATEMENT OF FACTS

The Externally “More Out Than Externally In/ $E=mc^2$ ”

Invention

I, Newman, an independent inventor, have had a substantial background in patents, having been the patentee of a number of commercialized inventions (Newman Summary Judgment affidavit). However, they pale in comparison to the results of my

20+ years of work on the invention now in issue.

Such “more out than externally in” has never been achieved before in an electromagnetic device, but has been achieved in other applications, including atomic fission (e.g. atomic bomb & reactor) and fusion (e.g. hydrogen bomb) by converting some of the matter internal to the device into energy, in accordance with Einstein’s accepted equation of $E=mc^2$. More “out than externally in” ipso facto is not contrary to accepted scientific law, ever since the acceptance of Einstein’s theories and the establishment of the conversion of matter into energy.

I, Newman, explained this conversion of matter into energy and other aspects of the operation of my invention in connection with my Figure 5 embodiment in my patent application, as follows:

“It is very important to understand that, the longer the length of the conducting wire in coil 205, the stronger will be the magnetic field produced and the less electric current that will complete the circuit and get back into the battery and destroy the mechanical source of the electrical current. This effect can be increased further by increasing the diameter of the conducting wire in coil 205 and then greatly increasing its length still further in the coil.

Reason: The gyroscopic particles making up the electric current interact with the atoms of coil 205. The more atoms in coil 205, relative to length, the longer it takes the gyroparticles of the electric current, to influence them and get out the other end of the

- 4 -

coil. It is then easily seen that, if the direction of the current into coil 205 is then reversed, this then even increases this lag time. Reason: The gyroscopic particles have inertia and are believed to be moving at the speed of light and are interacting with the gyroscopic particles making up the atoms of conducting coil 205. These atoms also have inertia and, when the direction of current is reversed into coil 205, the incoming current then collides with the current already in coil 205 going in opposite directions.

This causes a brief hesitation during the time the current already in the coil is being forced to reverse its direction, thereby then reversing the direction of the atoms within coil 205 which have already been influenced to become aligned. This causes a constant force throughout the circuit, but does not allow very much current to get back into the battery 201 to destroy the mechanical means which initiated the release of electric current in the first place.

Therefore, it should be further understood that, the faster the current direction reverses into the coil 205, the more efficiently the matter of battery 201 is converted into pure electrical energy ($E=mc^2$), without destruction of the mechanical situation that initiates the electrical current release.

It is also important to understand that, the stronger the magnetic field coming from the mass of magnet 200, the greater will be its rotational speed. Additionally, the greater the magnetic field coming from the mass of coil 205, the greater will be the rotational speed of magnet 200, and, up to a point, the greater the electric current input from battery 201, the greater will be the percentage of the atoms making up coil 205 that are aligned. This probably has the same relationship as does achieving atom alignment in conventional magnetic materials. Once complete atom alignment is reached in coil 205, no amount of current will cause those atoms to increase the strength of the magnetic field emitting from those atoms.

Therefore, it should be clear that, for a given input of electric current from battery 201, the most efficient design is one in which the most atoms of coil 205 are influenced to atom alignment by that given electric current, which means increasing the diameter and the length of the conducting wire of coil 205 to the point that the strength of the magnetic field produced is sufficient to cause rotation

of the magnet 200 to a speed that allows none or at least very little of the electric current which initially comes from the battery 201 and destroy or reduce the mechanical effect which induced the conversion of the matter of battery 201 in electric current in the first place.”

Professor Roger Hastings, a physicist, at trial testified that:

“The most important design rule specified by the inventor is that the length of wire in the motor coil be very long; preferably long enough so that the switching time between current reversals is shorter than the time required for the propagation of the current wavefront through the coil. Various models contain up to 55 miles of wire, with air core coil inductances of up to 20,000 henries.”

In this configuration, Professor Hastings testified:

“The permanent magnet armatures have very large magnetic moments. Thus the motors exhibit high torque with low current inputs. The motors generate large back current spikes consisting of pulsed r.f. (radio frequency) in the 110-20 MHz (megahertz) frequency range. These spikes provide large mechanical impulses to the rotor, energize fluorescent tubes placed across the motor, and tend to charge the drycell battery pack.”

As a result, Professor Hastings concluded:

“The total generated energy, consisting of, (a) mechanical, (b) mechanical friction, (c) ohmic heating and (d) light is many times larger than the battery input energy.”

See Appendix D.

My life's work of this Pioneering Invention is of such great significance it will change in a phenominally beneficial way the entire economic position of all Peoples of this earth, eliminate pollution, make space travel a practical reality, eliminate hunger, and do more to bring World Peace than all the Kings, Politicians, Presidents, Dictators, etc., who have ever lived.

I sincerely ask the Honorable Supreme Court to hear the meritorious case of my Life's Work concerning a "Pioneering" Revolutionary Energy Invention, that is of tremendous benefit to all of Humanity. The following quotes are only a sample of the numerous competent scientific minded individuals over the years, who have studied my Life's Work and have so verified:

"The future of the human race may be dramatically uplifted by the large-scale commercial development of this invention." - DR. ROGER HASTINGS, Principal Physicist, SPERRY CORPORATION.

"If the manner in which Joseph Newman conducted his experiments and the results were made known to the

- 7 -

industrial or engineering community then, in my opinion, several companies and/or individuals possess the expertise and capabilities to construct the hardware required to fully exploit the apparent capability of his new concepts.” - DR. ROBERT E. SMITH, Chief, Orbital and Space Environment Branch, George C. Marshall Space Flight Center, NASA.

“You have opened an area in Astrophysics which may revolutionize the magnetic energy problem which is now the most paramount problem in future energy and space travel. I do believe with proper research funds, the results would not only be a great financial boom to your financiers, but would lead to developments that will be practical and beneficial to all mankind and develop a new step in science.” - DR. E. L. MORAGNE, MORAGNE RESEARCH & DEVELOPMENT COMPANY, (Electromagnetic pioneer in the development of the first atomic bomb).

“Mr. Newman has demonstrated many working models of his invention, an ‘energy machine’ which is based on his own ideas. This invention means an unlimited source of energy and will introduce new ideas into the science of physics.” -

DR. NICHOLAS TSOUPAS, Physicist, A.W. Wright
Nuclear Laboratory, YALE UNIVERSITY.

There have been more than 30 independent scientific minded individuals, who have come to my home and scientifically tested said "Pioneering" Energy Invention and verified it works!

Said numerous tests caused the SPECIAL MASTER chosen by the Lower District Court of Columbia, and had said his credentials were superb, who was nominated by Respondent, and who, himself had been a former Commissioner of Patents & Trademarks, and who had an Electrical Engineering background, to state:

"Evidence before the Patent and Trademark Office and this Court is overwhelming that Newman has built and tested a prototype of his invention in which the output energy exceeds the external input energy; there is no contradictory factual evidence."

I had originally asked for trial by jury, which was denied and I had objected to the Lower Court's hiring a Special Master, as I knew it would cost me additional money and I had 30 competent, independent eyewitnesses to the operability of said "Pioneering" Energy Invention and the Respondent had Zilch.

When Respondent was challenged by this fact, Respondent quoted U.S. Patent Law as to what they were directed to

do - U.S. Patent Office has no facilities for testing an invention and must depend upon affidavits of operability presented by applicant - While totally ignoring the fact Respondent had consistently violated said Patent Laws and had discounted all testing by applicant and other numerous independent scientific minded individuals by claiming we were all incompetent or possibly deliberately being misleading.

Such violations by Respondent had caused the Special Master to rule:

“Defendant intentionally did not consider the formalities of Plaintiff’s application or the patentability of Plaintiff’s claims under 35 USC sec. 102/103.”

Along the same line of chastisement against Respondent the Special Master ruled:

“Key to the decision of the Board of Appeals is its findings that a motor like Figure 6 of Newman’s application ‘would not and could not be made to operate at an efficiency level greater than 100% as recited for example in generic claim 43. Such a machine is impossible.’” That finding is clearly erroneous.”

The Lower District Court had stated it had no scientific expertise of the field and that the hiring of a Special Master would save me funds.

I was charged more than \$11,000.00 for said SPECIALMASTER and then the Lower District Court threw out the findings of the SPECIAL MASTER, without any evidence from Respondent against the SPECIAL MASTER FINDINGS, other than irresponsible remarks inferring the SPECIAL MASTER “believed in the Tooth Fairy.”

Said action of the Lower Court was not only a violation of Federal Law, (F.R.C.P. 53)¹ concerning the hiring of a SPECIAL MASTER, but was also a violation of the Lower Court’s reason for hiring said SPECIAL MASTER over my objection.

The Lower Court then demanded I send a prototype of said “Pioneering” Energy Invention to a Biased and Prejudiced sister office of Respondent - The National Bureau of Standards. Both the Respondent and its sister office - National Bureau of Standards were already on the Lower Court Record testifying without ever testing said “Pioneering” Energy Invention, that its operability was “Impossible.”

The Lower District Court’s actions were so unjust, I filed Writs of Mandamus to the Higher United States Court of Appeals for the Federal Circuit. Said Higher Court upheld in part

¹ “In an action to be tried without a jury the court shall accept the master’s findings of fact unless clearly erroneous.”

one of said Mandamus concerning the testing of said "Pioneering" Energy Invention and even at a later date pointed out that the National Bureau of Standards were coming into said testing with a prejudiced opinion, as they had even inferred to said Higher Court that I was a fraud, (In re Newman, 782 F.2d 971 (Fed. Cir. 1986)).

Said prejudiced illegal testing by the National Bureau of Standards deliberately followed a procedure of grounding all tests of said "Pioneering" Energy Invention, which they knew from prior Deposition Testimony would dump all excess energy of said "Pioneering" Energy Invention and cause the false results to indicate it was not operable.

Said deliberate, hostile, and unjust action by the Respondent and sister office - National Bureau of Standards is screamingly exemplified by them presently and said Lower District Court attempting to charge me more than an additional \$100,000.00 for their said unjust actionx (See Appendix C). Said horrifying ridiculousness is exemplified by any competent electrical engineering being able to totally test said "Pioneering" Energy Invention in a very short time at virtually no cost. More than 30 competent independent individuals have already done so! This is a blatant violation of Article VIII of the Amendments to the Constitution of the United States.

Said unjust action even of this date by said Lower District Court exemplifies why I was correct in not going to the Trial of my Life's Work at said Lower District Court protesting my absence, "was to accent the Lack of Justice in Said Lower District Court."

It is further exemplified in that as of this date I have spent close to One Million Dollars since filing for a patent on said "PIONEERING" Energy Invention in 1979 in trying to secure a just U.S. Patent and which has resulted in my being financially drained.

It should be noted that at the trial, the NBS tester (Dr. Heber) himself admitted that his tests may have been conducted wrongly, and that the Patent Officer's expert, Dr. Johnson, also admitted that, if in my device there was a conversion of matter through energy "as I had described in my patent application," my invention would not be in conflict with the accepted Laws of Physics, particularly of thermodynamics.

Finally, the Court criticized me for not cooperating with the NBS tests and somehow consider me bound by the results. However, these were not set up as "inter partes" tests, and the trial court never established any procedures or requirements that I comment on the NBS tests before they were run. Indeed, there was not cooperation even desired by the NBS, and I had to go to the

Appeals Court to prevent the NBS from having the right to destroy my machine or to keep it until after the trial! (In re Newman, 782 F.2d 971 (Fed. Cir. 1986).

I believed all along that the NBS tests were merely a bureaucratic setup and the fact that they only reported on tests the Patent Office knew would give false results and did not run a single one of the many different tests run by the 30+ scientists and technicians establishing that my invention worked, shows that the NBS tests were just a set-up.

• In a “145” Proceeding the USPTO Record is the “Evidentiary Nucleus” -

As the district court noted (5 USPQ2d at 1885;

Addendum II):

“A decision of the PTO Board of Patent Appeals, whether reviewed by way of a direct appeal to the U.S. Court of Appeals for the Federal Circuit under 35 U.S.C. Section 141 or a civil action to set it aside before the U.S. District Court for the District of Columbia pursuant to 35 U.S.C. Section 145, is presumptively correct. *Fregeau v. Mossinghoff*, 776 F.2d 1034, (227 USPQ 848) (Fed. Cir. 1985). It may be overturned only if ‘clearly erroneous,’ by which is meant that the reviewing court must be of the ‘definite and firm conviction’ that a mistake has been made. *Id.* at 1038, (227 USPQ at 851) (quoting *Anderson v. City of Bessmer City*, 470 U.S. 564,573 (1985)). Review by the court of appeals is confined to the PTO record and the Board’s decision. When new evidence is presented in a ‘de novo’ proceeding in a civil action in District Court, the record before the PTO is nevertheless the evidentiary nucleus’, *id.* at 1037, (227 USPO at 85) which the court

must consider in conjunction with the evidence adduced at trial in making its independent findings of fact. *Id.* at 1038 (227 USPQ at 851).”

However, after correctly citing the law, the district court merely gave it “lip service.” It then merely concluded, without detailing a single substantive consideration, iota of substantive evidence or analysis of any of the substantial evidence from the USPTO proceedings:

“This court, having made such a consideration, concludes, as did the Board, the Newman’s device lacks utility (in that it does not operate to produce what he claims it does), and the Board’s decision is not clearly erroneous.”

What happened to the “overwhelming evidence,” detailed above, found by the eminent Master supporting the operability of the invention? What happened to the “evidentiary nucleus?” What happened to the many tests by many different individuals, filed in the PTO record, all coming to the same conclusion that the invention worked?

Indeed, it is ironic that I am the only one that had the one test run that the Patent Examiner and the Patent Office said was the most important type of test, namely a “mechanical (break) output” test and it likewise confirmed that my device worked!

All of the foregoing unjust actions have caused Eleven U.S. Congressmen to introduce Bills on my behalf into Congress for the issuance of a "Pioneering" Patent on said Energy Invention.

I have been on numerous Television Shows, such as CBS, NBC, and ABC National News, CNN, The Johnny Carson Show, The Today Show, and others, numerous Radio Talk Shows across the country as well as Hundreds of written articles. News People, from Germany, Japan, Sweden, Australia, India and others have covered my Life's Work and said "PIONEERING" Energy Invention.

To make sure my Life's Work was not stifled by said above unjust actions, I published the same in a book I had written titled, "The Energy Machine of Joseph Newman." I have sold 7 thousand copies worldwide of the same majorily by word of mouth. More than 200 major entities, such as Corporations, Libraries, Military, etc., have purchased said Book.

I have mae my livelihood by inventing since 1962 and have more than 6 U.S. Patents.

Contrary to said above unjust actions of the United States, I have received 7 Foreign Patents on my "PIONEERING" Energy Invention: Spain, India, Italy, Venezuela, Mexico, Argentine, and South Africa.

- 16 -

I have recently signed a contract for Manufacture of said "PIONEERING" Energy Invention, with a U.S. Company and others are now coming forward. One of their greatest concerns is whether I will be unjustly denied a U.S. Patent for my Life's Work.

V.

REASONS FOR GRANTING THE WRIT

Said unjust actions stated above have resulted in U.S. Companies prior to this time not to contract for Manufacture.

Said Higher Court of Appeals have upheld the unjust actions of said Respondent and said Lower District Court with the same blatantly false conclusion stating that said "PIONEERING" Energy Invention does not operate.

There is precedence for what I ask (U.S. Verses Adams, 383 U.S. 39, 15L Ed 2d 572, 86S. CT. 708 (1966)). To personally give a demonstration of a Production Model of said "PIONEERING" Energy Invention that is culmination of my Life's Work for all Humanity in the presence of the Honorable Supreme Court of the United States.

The file of this case is voluminous, but the issue is simple. Does said "PIONEERING" Energy Invention work. Said

Demonstration would use standard adequate testing equipment, to which if any convention electrical motor is hooked to and to a power source, the convention motor will be proven to draw current from the power source. Opposite to that, my "PIONEERING" Energy Invention will instantly be proven to be sending more current back to the power source than came from the power source.

To allow said stated injustice to stand is to send a blatant message for all time to every potential inventor, who knows it may take years of his life to perfect some "PIONEERING" Invention of Benefit to Humanity and that they can expect no Justice from the U.S. Patent Office or the Federal Court System of the United States. And that they can expect their Life's Work and the Fruits of their Labor to be openly encouraged to be stolen from them by others. And that their Constitutional Rights may be blatantly violated as to no trial by jury no matter the tremendous monetary value of their Discovery and to receive "excessive fines imposed." and "cruel and unusual punishment inflicted" for attempting to acquire their legal constitutionl "exclusive Right to their respective Writings and Discoveries."

The above facts are exemplified as TRUTH by a quote from Mr. Paul Gomery (a long time Expert Advisor to the Judiciary Committee on Patent Law), who witnessed the Lower

District Court and Respondent not accepting Findings of Special Master, and when questioned by Newsmedia about the same in front of said Lower District Court House, stated: "There is not but one word for it, 'Atrocious.' Long ago the U.S. Patent Office should have issued this patent."

I have fully shown that the Patent Office was clearly erroneous in rejecting my patent application, and the Special Master's Findings of Operability of the same, and Respondent has not carried their corresponding evidentiary burden at the trial.

This is not the first time the Patent Office has stood in the way of a Revolutionary, Extremely Valuable Invention. The Patent Office also put Orville and Wilbur Wright through an expensive, multi-year battle continually claiming that it was impossible for man to fly. For years the Wright Brothers had in fact flown and had presented substantial evidence of their success to the Patent Office. (See "The Wright Brothers' Pioneering Patent," American Bar Association Journal, October 1979, Vol. 65, pp. 1512-1518.)

VI

CONCLUSION

This case presents important constitutional issues regarding the stimulation of creativity of the individual by which the inhabitants of this nation benefit therefrom. This Court here has an opportunity to clarify this will be done in accordance with guidelines given in the Constitution of the United States. This case has established a dangerous precedent which if not corrected, will most definitely stifle creativity in this nation as said "Atrocious" injustice precedent will be a potential Guillotine over the mind of every Inventor of this country from this time forward.

I sincerely ask this Honorable Supreme Court of the United States to hear this meritorious case.

Respectfully submitted,

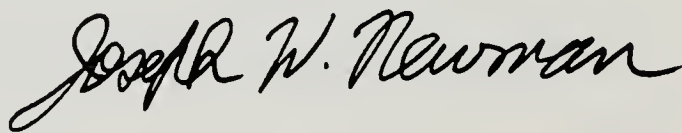

DATED: February 21, 1990

JOSEPH W. NEWMAN

RT. 1, BOX 52

LUCEDALE, MISSISSIPPI 39452

Note: The Corrupt Supreme Court — which was stacked by Ronald Reagan — denied hearing the tremendously important case concerning the energy machine technology — a case which contained numerous, constitutional violations by the U.S. Patent Office. Mike Barkley of Idaho could not believe that the Supreme Court denied hearing this case. The U.S. Supreme Court denial follows:

SUPREME COURT OF THE UNITED STATES
OFFICE OF THE CLERK
WASHINGTON, D. C. 20543

May 14, 1990

Mr. Joseph W. Newman
Rt. 1, Box 52
Lucedale, MS 39452

Re: Joseph W. Newman
v. Donald J. Quigg, Commissioner of Patents and
Trademarks
No. 89-1504

Dear Mr. Newman:

The Court today entered the following order in the above
entitled case:

The petition for a writ of certiorari is denied.

Very truly yours,

Joseph F. Spaniol, Jr., Clerk

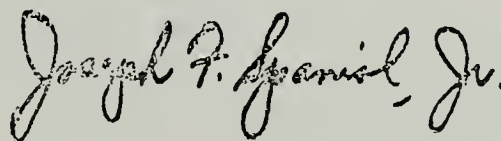

Shortly thereafter a U.S. Marshall came to my home in Lucedale, Mississippi with Summons to a Federal Court in Jackson, Mississippi. The intent of this Summons was to steal my home, car and other assets to pay the fiendishly-corrupt fine of more than \$100,000 imposed by the Corrupt Judge Thomas Penfield Jackson. I recommend that the reader refer back to pages 274 through 279 of this book which features facts proving the corruption of Judge Thomas Penfield Jackson. Such corruption is further proven by the fact that Thomas Penfield Jackson was 'knee-deep' in the Watergate Scandal at which time he was the attorney for John Mitchell and involved with the corrupt "Committee to Re-Elect the President" (C.R.E.E.P. — Nixon's reelection committee).

Reagan appointed Thomas Penfield Jackson as a Federal Judge right after Reagan was elected President. This was Jackson's 'reward' for having defended Mitchell. Looking at the Facts, it should be obvious to all people that it was no accident that Thomas Penfield Jackson was assigned my case against the corrupt Patent Office bureaucracy.

APPENDIX C

UNITED STATES DISTRICT COURT
FOR THE DISTRICT OF COLUMBIA

JOSEPH W. NEWMAN,
Plaintiff,
v.
DONALD J. QUIGG,
Commissioner of Patents
and Trademarks,
Defendant.

Civil Action No.
83-0001
Judge JACKSON

FILED

DEC 15 1989

CLERK, U.S. DISTRICT COURT
DISTRICT OF COLUMBIA

JUDGMENT FOR EXPENSES

This matter having been tried by the Court, and the Court having entered a judgment on the merits in favor of defendant on February 17, 1988, the U.S. Court of Appeals having affirmed the judgment, and upon consideration of defendant's request for expenses, the parties having been heard, it is

ORDERED that judgment is entered in favor of the Commissioner and against plaintiff Joseph W. Newman and intervenor Commerical Technology, Inc., jointly and severally, in the amount of \$1,575.79 and it is

FURTHER ORDERED that judgment is entered in favor of the Commissioner and against Joseph W. Newman in the additional amount of \$103,015.48.

Date: 12/15/89
At: Washington, D.C.

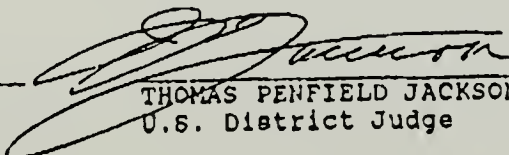
THOMAS PENFIELD JACKSON
U.S. District Judge

(N) 2

IN THE UNITED STATES DISTRICT COURT
FOR THE SOUTHERN DISTRICT OF MISSISSIPPI
SOUTHERN DIVISION

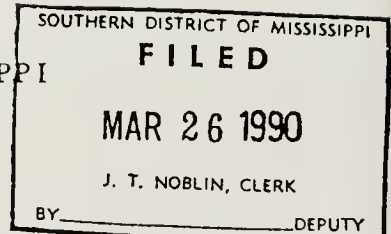

JOSEPH W. NEWMAN,
Plaintiff

vs.

CIVIL ACTION NO. S90-0105(G)

DONALD J. QUIGG, COMMISSIONER
OF PATENTS AND TRADEMARKS,
Defendant

ORDER FOR APPEARANCE OF JUDGMENT DEBTOR

Defendant having moved the Court for an Order requiring the Plaintiff, Joseph W. Newman, to appear and testify at a judgment debtor examination, and the Court being sufficiently advised.

IT IS ORDERED that Plaintiff, Joseph W. Newman, appear at Room 520, Federal Courthouse, 245 East Capitol Street, Jackson, MS, 39201 at 9:00 a.m. on April 30, 1990, to answer questions concerning his property.

IT IS FURTHER ORDERED that Plaintiff, bring with him/her:

1. Copies of personal income tax returns for the years 1986, 1987 and 1988.
2. Copies of all personal and business bank statements for the years 1987, 1988 and to date.
3. Copies of utility bills, specifically electric, gas, water, and phone, as well as bills for any unusual or large expenses; such as medical bills.
4. Copy of title or deed of personal residence if owned by you or any member of your family. If not, a copy of proof of ownership by unrelated party. If you rent, bring copies of last six months rental receipts.
5. Copy of title or license of automobile driven by you or your spouse.

PLAINTIFF, JOSEPH W. NEWMAN, IS HEREBY ADVISED THAT FAILURE TO APPEAR AT THE TIME AND LOCATION SET FORTH ABOVE MAY RESULT IN A BENCH WARRANT BEING ISSUED FOR HIS/HER ARREST. A COPY OF THIS ORDER, TOGETHER WITH COPIES OF PLAINTIFF'S MOTION AND CERTIFICATE, SHALL BE SERVED UPON DEFENDANT BY THE UNITED STATES MARSHAL NO LATER THAN 5 DAYS PRIOR TO HEARING.

SO ORDERED THIS 21 DAY OF March, 1990.

(s/) John R. Campbell III
UNITED STATES MAGISTRATE

A TRUE COPY, I HEREBY CERTIFY.

J. T. Nebbia, CLERK,

By:

[Signature]
Deputy Clerk

As a result of the corrupt actions of Thomas Penfield Jackson, I was forced to file bankruptcy to keep corrupt U.S. Government bureaucrats from taking my home and possessions.

SOUTHERN DISTRICT OF MISSISSIPPI
FILED
APR 24 1990
J. T. NOBLIN, CLERK
DEPUTY

IN THE UNITED STATES BANKRUPTCY COURT FOR THE
SOUTHERN DISTRICT OF MISSISSIPPI

890-0105 (4)

IN THE MATTER OF: *Joseph W. Newman*

IN BANKRUPTCY NO.

9007931 SEG

DATE FILED: APR 24 1990

NOTICE OF BANKRUPTCY AND OF AUTOMATIC STAY

TO THE DEBTOR, HIS CREDITORS AND ALL OTHER PARTIES IN INTEREST:

ORDER OF RELIEF has been granted the above-named debtor on a petition filed by (or against) him on the date above, and notice is hereby given that:

As a result of this bankruptcy, certain acts and proceedings against the debtor and his property are stayed as provided in U.S.C. §362(a). Violations of this automatic stay are grounds for contempt citation and a fine up to \$250.00 under Rule 9020 of the Bankruptcy Code.

DATED AT Biloxi, Mississippi APR 24 1990

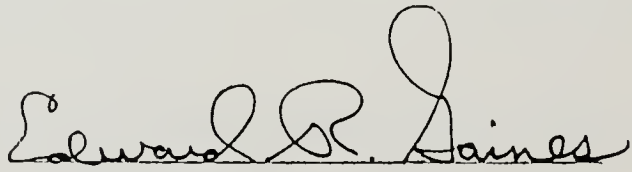

EDWARD R. GAINES
UNITED STATES BANKRUPTCY JUDGE
POST OFFICE DRAWER 1280
BILOXI, MISSISSIPPI 39533

BANKRUPTCY LEGALLY VOIDS ALL GARNISHMENTS. ALL EMPLOYERS SHOULD PAY OVER TO THE DEBTOR FULL PAYCHECK FROM THE DATE OF FILING WHICH IS GIVEN ABOVE. ANY EMPLOYER FAILING TO COMPLY OR ANY JUDGMENT CREDITOR FAILING TO REMOVE GARNISHMENT MAY BE FINED \$250.00 FOR CONTEMPT OF COURT.

The corrupt U.S. Government is now taking this to a corrupt Federal Court which has been stacked by the Reagan and Bush Administrations to circumvent the Homestead Act and still attempt to steal my home, etc., and simultaneously cost me even more legal fees.

GOD — through all of these persecutions and betrayals my loved ones and so-called friends — has turned me to STEEL! This has happened exactly as Nostradamus once predicted:

“From the dark realm of old Charon the Phoenix will be reborn, the last and greatest of the firebird’s sons.”

The result is that these events have enabled me to better serve Humanity no matter what the cost to myself!

I now push absolutely for the immediate production of the energy machine Technology. I will give public demonstrations of powering and air conditioner, table saw, etc., with my energy machine motor while the watt meter outside the building containing the demonstration will not even hardly move. This will prove that all home appliances using motors constructed with my Technology will cost the homeowner hardly one dime.

Question— How much persecution does an individual have to endure before the People will wake up and see that this individual fights for them and not for himself?

Question — How much persecution does this individual have to endure before the Peoples’ Consciences will bother them and cause them to become courageous and help the individual fight for their own well-being?

This entire book is directed to teach the reader to Question, Think and Act to bring forth TRUTH! I have consistently stated that the Reagan and Bush Administrations are evil. The facts in this book alone — so verify. But the facts of Reagan and Bush Administration ‘screamingly’ so verify. Even this very week as I write, Bush now says that he will forget his campaign promises and says that he will raise the taxes on the People!

People — “WAKE UP!” Via corrupt favoritism,

etc., the Reagan and Bush Administrations have raised the deficit more than anyone in history. The recent Savings and Loan Scandal of billions of dollars is only one example. And now Bush says that you the “People” are stupid and will blindly go along with his tax raises on the People to pay and reward the corruption and evil of the Reagan and Bush Administrations without any criminal penalties against the guilty.

Turn to Revelations, Chapter 13, verse 17 and 18 of the New Testament:

“Here is wisdom. Let him that hath understanding count the number of the beast: for it is the number of a man; and his number is Six Hundred threescore and six”

Obviously the essence of God has marked the man distinctly with the number “666”. The Bible speaks in metaphor. Obviously the referral to verse 16 of “mark in their right hand” means by your physical actions you prove to the observer that you serve the 666 man.

And “in their foreheads” means that by your thoughts, statements and actions you prove to the observer that you serve the 666 man.

God at this time has so marked the 666 man: RONALD WILSON REAGAN at birth was given six (6) letters in each of his three names = “666”! Ronald Wilson Reagan was born on February 6, 1911. Add the numbers $6+1+9+1+1 = 18$ or $6 + 6 + 6!$

Ronald Wilson Reagan upon leaving the White House was presented with a mansion in California as a gift from his rich cohorts. This mansion was already publicly known as the “Demon House” and was marked by the street address of “666”. These cohorts had the address changed to 668 — but it makes no difference since God had clearly marked the man Reagan by the number “666” and the actions of the Reagan and Bush Administrations blatantly scream out the number “666”! When he ran for President, Bush even continually praised the Beast exactly as the Bible said that he would!

Tomorrow — **Monday, July 2, 1990** — is exactly 54 years since I was born. This book stands as a testament of purity that God has touched me

and molded me to serve All Humanity.

This Decade is the end of Time as we have known it and then we who will be left will go into a Thousand Years of Peace. Many people over the centuries have so-claimed such peace, but they have not been given the talent to present consistent, factual proof from around the world of its Truth.

I have been chosen and given the talents not for myself, but to serve You the People. I challenge you to acquire the VHS film whereby I present these Facts to the World. Anyone who obtains this tape can make copies and give them to others at no charge from myself — but the tape cannot be edited or added to in any way.

People from around the world have been simultaneously awakening and challenging the status quo in a way never seen before in history. Only the U.S. People have not acted in this Awakening. Now is the time! Question + Think = TRUTH.

As I finish this 6th Edition of my Life's Work this Sunday, July 1st, 1990, I sit writing all alone in the backwoods of Lucedale, Mississippi with the exception that God is with me and hopefully you the reader will know that God speaks through me to you for your well-being — **not mine!**

I urge you to contact your Senator and Congressman NOW and demand that they introduce Private Relief Bills in the Senate and Congress to allow Joseph W. Newman to be immediately issued a Pioneering Patent for his Energy Machine Invention.



Joseph Westley Newman
Sunday, July 1, 1990

P.S. Protect your copy of this book! I have been informed that people are stealing or destroying the copies that were purchased by libraries!

Addendum — July 3, 1990:

On Monday, July 2, 1990 (my 54 birthday) 1400 Moslem pilgrims (the number reported in the newspapers) were killed during a stampede inside a tunnel in Mecca. This is no coincidence that this occurred on my birthday. The 1400 number also represents God's "hand print" as I have discussed above. King Fahd of Saudi Arabia called the tragedy "God's will, which is above everything."

I urge the reader to take note of these important happenings which serve to underscore God's message to the world.

Bibliography

Books

- Black, Joseph. *Lectures on the Elements of Chemistry*, published by John Robinson, Printed by Mundell and Son, for Longman and Rees, London, and W. Creech, Edinburgh, 1803.
- Brancazio, Peter J. *The Nature of Physics*, MacMillan Publishing Co., Inc., New York, 1975.
- Corliss, William R. *Handbook of Unusual Natural Phenomena*, Sourcebook Project, Glen Arm, Maryland, 1977.
- Fite, Gilbert and Reese, Jim. *An Economic History of the United States*, The Riverside Press, 1959, Cambridge, Massachusetts.
- Hoyle, Fred. *Astronomy*, Rathbone Books, Ltd., London 1962.
- _____. *Frontiers of Astronomy*, New American Library, New York, 1964.
- Huntington, Ellsworth. *Earth and Sun*, Yale University Press, New Haven, 1923.
- Lapp, Ralph E. *Matter*, pgs. 70 and 71, LIFE SCIENCE LIBRARY, Time Inc., New York, 1965.
- Newton, Isaac. *Principia*, University of California Press, Los Angeles, 1934.
- Paine, Thomas. *The Age of Reason*, Citadel Press, a division of Lyle Stuart, Inc., 1974, Secaucus, New Jersey.
- Sherrill, John L. *They Speak With Other Tongues*, a SPIRE book published in New Jersey by Jove Publications, Inc., 1984, by arrangement with McGraw-Hill from the 1964 edition.
- Tolstoy, Ivan. *James Clerk Maxwell: A Biography*, Canongate Publishing Ltd., Edinburgh, 1981.
- Watts, Dr. Isaac. *The Improvement of the Mind*, London, 1809.
- Whipple, A.B.C. *Planet Earth: STORM*, pg. 102, TIME-LIFE BOOKS INC., Chicago, Illinois, 1982.
- Williams, L. Pearce. *Michael Faraday*, Chapman and Hall Ltd., London, 1965.

Articles

- Discover*, "Much Ado About Nothing," pgs. 76-80, June, 1985.
- Science Digest*, "Magnetic Whirlwinds," pg. 26, July, 1985.
- Science News*, "When the Sun Went Strangely Quiet," pgs. 154-156, March 6, 1976.
- _____. "Seismicity in sync with the sun?" pg. 271, April 27, 1985.
- _____. "New Heights in Superconductivity," pg. 23, January 10, 1987.
- _____. "Superconductivity: Physics Rush," pg. 196, March 28, 1987.
- Time Magazine*, "The Wandering Poles," pg. 54, December 13, 1968.
- Time Magazine*, "The Case of the Cosmic Bends," pg. 57, August 6, 1984.
- U.S. News and World Report*, "Patent System ... A Drag on Innovation," pgs. 45 and 461, February 2, 1981.

Additional Reading of Interest

- Huntington, Ellsworth. *Civilization and Climate*, Yale University Press, New Haven, 1922.
- _____. *The Human Habitat*, D. Van Nostrand Co., Inc., 1927.
- _____. *Mainsprings of Civilization*, John Wiley and Sons, Inc., New York, 1945.
- _____. *World-Power and Evolution*. Yale University Press, New Haven, 1920.

INDEX

In some cases, the listed page numbers only represent the principal areas where the subject is discussed.

A

action-reaction effect, 50
Affidavits:
 Gillis, Dr. John P., 232
 Hastings, Dr. Roger, 36-39, 229
 list of endorsers, 40-41
 Matherne, Robert J., 235-237
 Newman, Joseph, 261-262
 Smythe, Arnold R., Jr., 230
 Soule', Evan R., Jr., 231
 Szuter, Eric, 234
 Trinko, Dr. J. Richard, Jr., 233
Appendix, 283
Archimedian Laws of Leverage, 57
Astronomy, 112-153:
 central electromagnetic field, 116ff., 135
 central entity, 141-143
 complex motions, 141
 Earth's magnetic field, 88, 116ff., 118
 Earth's magnetic poles, 121-128
 Earth's orbit, 145
 earthquakes and tornadoes, 144-153
 experiments of Joseph Newman, 130-134
 Jupiter's magnetic field, 136
 Moon's magnetic field, 117ff., 125
 our galaxy's magnetic arc, 141-142
 planetary alignment, 146-148, 151-152
 planets' tilts, 132
 Pluto's inclination, 128
 right-angular orbits, 143
 stellar alignment, 138
 Sun's magnetic field, 117ff., 131-132
 sunspots, 120-121, 133-135
 weather effects, 137-153, 284-288, 332
atoms, 52, 73
atom alignment, 8, 10-11, 49-50, 53, 55, 58, 68, 76f., 83-84

B

Bacon, Francis, 103
battery, 50-52, 56, 60, 69, 333, 348-349
Bermuda Triangle, 138-140
Bernoulli, Daniel, 104
Black, Joseph, 102-110
Boyle, Robert, 104
Brancazio, Peter J., 71, 96
Brewster, David, 74
Burton, Dan, 294

C

Caloric Theory, 102ff.
cancellation effect, 55, 58, 65, 83
capacitor, 69
Carnot, Sadi, 109
catalyst, 18, 50, 57, 62, 66, 69
Charles, Jacques, 104
Clausius, Rudolf, 109
coil discussion, 16-20, 49, 55, 57

cold, 102-110
commutator, 21, 60-69, 292
CONDUCTING coil embodiment (Energy Machine), 18-69
conducting system, 53, 58, 347-349
Congressional Action, 294, 334
conversion efficiency, 20-21
Cooper, Paul R., 253
copper, nature of, 15
Corliss, William R., 140
correspondence (Achievement vs. Apathy), 154-237
cryogenics, 53, 289-290, 330-331
cyclotron, 329-330
current spike, 65, 69

D

Dalton, John, 74, 104
Davy, Humphry, 103, 107
Devil's Sea, 138-140
Dirac's Equation, 72
Duggan, Donovan F., 258

E

Earth and Sun, 133ff.
Earth's magnetic field, 88, 116ff., 118
economics, 253-257
Edison, Thomas, 84
Einstein, Albert, 72, 101
Einstein's Equation of $E = MC^2$, 9-11, 13, 15, 20, 55-56, 59, 60, 70, 74, 79, 81-82, 101-103, 108-110, 116, 330, 333, 347-348
Einstein's General Theory of Relativity, 97
electric charges, 9, 72, 74, 91ff.
electric current, 16-18, 58-59, 69, 347-349
electric field, 76, 95
electrical storms, 88, 149ff., 332
electrolysis, 51, 59-60, 70, 87
electromotive series, 93
Energy Machine:
 automobile, 333, 343, 347-349
 back-emf flow, 21, 57
 commutator, 21, 60-69, 292
 CONDUCTING COIL EMBODIMENT, 18-69
 Large Prototype (5000 lbs.), 66, 20-21, 22ff.
 Medium Prototype (900 lbs.), 22ff., 56ff.
 Small Prototype (200 lbs.), 36ff., 59, 67
 GAS EMBODIMENT, 88-90
 gyroscopic particles, 62-63
 new magnetic motor/pump design, 292
 photographs, 21, 36, 67
 proper design, 53-55, 65, 68
 rotating magnet, 65-67
 STATIC EMBODIMENT, 83-84
 test results by Dr. Hastings, 22-39
 torque created, 57
 universal energy machine, 140, 293
entropy, 110
Everett, Milton, xi, 14

F

Faraday, Michael:
 describing magnetic fields, 12
 First Law of, 51, 59f., 70
 gravitation, 97
 magnetism and optics, 75
 neutrality to a magnetic field does not exist, 83, 121, 140
 recognition of achievement, 72

Faraday's Generator, 4-6, 147

Faraday's Law of Electrolysis, 51, 59-60, 70, 87

First Law of Thermodynamics, 82

Flannery, John P., II, Esquire, 275-277, 338-341

flywheel, 5

G

Galambos, Andrew J., *ix*,
 GAS EMBODIMENT (Energy Machine), 88-90

Gilruth, Dr. Robert, 121-124

God, discussion of, 243-252

Gomory, Paul, 261, 263-266

gravitation:
 nature of, 88, 91-95, 116, 210-211
 relation to inertia, 96ff.

Gyromas, *xi*

gyroscope:
 actions, 6-7
 comparison with Faraday's Generator, 6-7
 comparison with quantum mechanics, 72
 right-angle resistance, 99

gyroscopic particles:
 action-reaction effect, 50ff., 67, 70, 76
 as commutator revolves, 62-63
 basic building block of all matter, 17, 72-73, 79, 82, 97,
 140, 153, 281, 329-330
 braking effect, 59
 cancellation effect, 55, 58, 65, 83
 coupling effect, 50
 cumulative effect, 58-59
 "electrical" or "magnetic," 52
 First Law of Thermodynamics, 51, 82, 109
 gravitation, 92-95, 116
 heat, 102-111
 helix motion, 12f.
 hydraulic effect, 50ff., 65-66, 70
 inertial effect, 99
 in a battery, 50-53, 69f.
 in a conductor, 53-54, 283-284
 in magnetic fields, 10ff., 62-63, 65
 Laws of Thermodynamics, 108-110
 lead powder demonstration, 85ff., 90
 light, 71, 74-79, 86-87
 motion of, 10-11, 18
 "negative" or "positive," 9, 72, 74-79, 88, 91-95, 97, 116
 proper, atom-oriented materials, 83f.
 quantum mechanics, 71ff.
 Second Law of Thermodynamics, 109f.
 shells of force, 10-12, 54-55
 space area, 104ff.
 Third Law of Thermodynamics, 110
 timing effect, 63, 65, 67, 69
 unified fields, 14, 72, 101, 116, 140, 153, 281
 Universal Energy, 82

gyroscopic particles (*Contd.*)

universal energy machine, 140, 293
 with a commutator system, 60-70, 283-284
 gyroscopic plane, 74-79, 99

H

Handbook of Unusual Natural Phenomena, 140ff., 150-151

Hastings, Dr. Roger, *xi*, 14, 21, 334:
 Affidavits, 36-39, 65, 229
 Declaration (testing on 5000, 900 lb. units), 22-35
 Declaration (particles within electromagnetic fields), 85
 heat, 102-111

Hertz, Heinrich, 79

Hoyle, Fred, 125-127, 140

Huntington, Dr. Ellsworth, 112, 133-135, 146

Hurricane Elena, 284-288

hydraulic effect, 50ff., 65-66, 70

I

inertia, 96-101
 Inverse-Square Law, 91-92

J

Jackson, Judge Thomas P., 274-277, 333-344
 judicial system, 274-279
 Jupiter's magnetic field, 88, 136

K

Kepler's Second Law, 134

Kerr, John, 75

kinetic energy, 5, 20, 57, 80ff., 87, 102-103, 329

Kirchoff's Law, 16

L

lasers, 151-152

Lavoisier, Antoine, 106

Lenz's Law, 59, 83

light, 71, 74-79, 281

lightning, 149ff., 332

lines of force, 1, 5, 10-14, 76, 118, 125-132, 139, 142-143

M

magnetic field:
 arc in center of our galaxy, 141-142
 atom alignment, 8, 49-50, 53, 83-84
 attraction and repulsion, 9-11
 conductor alignment, 283-284
 copper's magnetic field, 15, 49
 cryogenics, 53, 330-331
 difference in strength, 49
 drawings of magnetic fields, 10-11
 electric fields, 76, 95
 electromagnetic fields and astronomical motions, 116-143
 electromagnetic fields and weather, 137, 144-153, 284-288
 galactic field, 125-127, 135
 gravity, 91ff.
 hydraulic effect, 50ff., 65-66, 70
 iron core, 15, 49
 nature of, 5, 9-14, 49, 76f.

magnetic field (*Contd.*)

niobium-tin, 53, 289-290
Oersted, Hans Christian, 15, 103
of Earth, 88, 116ff.
of Jupiter, 88, 136
of the Moon, 117ff.
of the Sun, 117ff.
permanent magnet, 8
sunspots, 120-121, 133-135
warping, 126-127
mass, 98ff.
Maunder Minimum, 137
Maxwell, James Clerk:
action at a distance, 12
his debt to Faraday, 20
matter-in-motion, 2-3
recognition of achievement, 72
Morgenstern, Christian, *ix*
Mueller, Eike, 14

N

"negative" and "positive," 9, 72, 74-79, 88, 91-95, 97, 116
Newman, Joseph:
Acknowledgements, *xi*
Affidavit on Patent System, 261-262
Declaration on super-conducting materials/cryogenic
magnets, 289
Letter to Dr. Gilruth, 121-123
Letters to individuals (Chapter 20), 155-161, 163-168,
210-211, 218-219
Letter to Paul Gomory, 268-272
Letter to Ralph Oman, 267
Press Release "To the People of the U.S.," 336-344
Prototype Proof of My Patent Applications Pending on an
Unlimited Source of Energy, 86-87
Quotation from Document to 56 universities, 116
Unusual Electrical Observations, 149
Who's Who, 227-228
Newman, Margaret Ellen Green, *xi*, 107, 149
news media, 260-261
Newton, Isaac, 59, 72, 91
Newtonian Mechanics, 79-80, 97
Newton's Third Law of Motion, 81, 83

O

Obvious Work, Force, Power, 17, 20, 57, 59, 80-82
(equations, 81), 91-93, 97, 98f., 105
Oersted, Hans Christian, 15, 103

P

patent system, 258-273, 294
"perpetual motion," 15, 110, 259-261
Pinwheel Cyclones, 285
potential energy, 80ff., 329
Principia Mathematica, 91
prism and spectral effects, 77-79
production efficiency, 20-21
proper, atom-oriented material, 83f.
Prototype Proof of My Patent Application Pending on an
Unlimited Source of Energy, 86-87
pump design, 292

Q

Quigg, Donald J., 273, 336ff.
quantum mechanics, 71ff.

R

radiation, 82
Robinette, Garland, *xi*

S

Schrodinger, Erwin, 72
Second Law of Thermodynamics, 109f.
Sherrill, John L., 249-252
single language, 280
Smith, Dr. Robert, *xi*, 112-115, 133, 137, 225
Soule, Evan R., Jr., *ix*, *xi*, 14, 245
sparkling in commutator, 292
Special Master, William E. Schuyler, Jr., 259
STATIC EMBODIMENT (Energy Machine), 83-84
sub-atomic particles, 60
Super Central Entity, 143
Superconductivity, 53, 289-291, 330-331

T

teaching system, 238-242, 329
thermodynamics:
Caloric Theory, 102-105
First Law of, 82, 109
heat, 102ff.
Second Law of, 109f.
Third Law of, 110
Thompson, Benjamin, 103, 107
Thomson, William, 110

U

Unified Field Concept, 14, 72, 101, 116, 140, 153, 281
Unobvious Work, Force, Power, 17, 20, 57, 65, 80-82
(equations, 81), 84, 91-93, 97, 105, 133, 283
uranium, 79

V

voltage, 50ff., 59, 347ff.

W

Warping of Space, 294
Watts, Dr. Isaac, 81
wave-particle duality, 71, 74
weather effects, 137-153, 284-288, 332
weather photographs, 286

X

x-rays, 78, 152

Z

Zeeman Effect, 77, 120-121

Joe Newman's Philosophy: 'If It Can't Be Done, It Interests Me.'

PHOTO BY MARY ANN WELLS



Joe Newman

A great thinker is seldom a disputant. He answers other men's arguments by stating the truth as he sees it.

— Daniel March

Joseph Newman is an original thinker who has the ability to visualize the mechanical essence of what he evaluates.

For the past 23 years, he has made his living by inventing. He holds eight patents for inventions which include plastic-covered barbell sets, a mechanical orange picker, a bike that does "wheelies," a knife that always lands point forward, and a new type of automobile rain-deflector.

Joe's formal education ended after his junior year of college so that he could pursue his true love — inventing. He did, however, continue to use his own brains and books to teach himself physics, chemistry, astronomy, and other areas of science.

At one point, Joe began to study the experiments and writings of the famous English scientist Michael Faraday, whose ideas led to the development of the modern electrical generator. Following 15 years of independent study, Joe explained his theory in a 133-page document which described a new technical process for understanding and utilizing a source of unlimited energy.

According to previously written statements, the Newman energy generator (its formal name) works successfully because "all mass is made up of electromagnetic energy, and if the proper, mechanically-designed mechanism is

built, one can change mass into pure electrical energy and/or rotational motion in a 100-percent conversion process." His three operational prototypes — one small, one medium in size, and a third weighing over 5,000 pounds with a 600-pound rotating magnet — have already been constructed. He built the three machines several years ago in his workshop, and he repeatedly emphasizes that he developed his conceptual theory over a period of 15 years before building the first physical prototype.

Joe Newman says that his invention is far more efficient than conventional nuclear energy and doesn't release any harmful radiation. He also says that his invention will replace all other forms of energy. It will be utilized in the home, by industry, and to produce commercial electrical energy at a small fraction of today's cost.

More than 30 competent physicists, electrical engineers, and technical individuals have signed Affidavits which state that Joseph Newman's invention does what he says it does: the external energy output exceeds the external, electrical energy input. This additional energy output is the result of the internal, magnetic energy within Joe's invention being converted to electrical energy. [This process is described in this book.]

Those who have signed the Affidavits include Milton Everett (biomass energy specialist from the Mississippi Department of Energy and Transportation), Mike Meatyard (electrical engineer for the Alabama Corps of Engineers), Eike Mueller (European Space Agency mission coordinator with NASA), and Dr. Roger Hastings (a principal physicist for Sperry-Univac, Inc., St. Paul, Minnesota).

In his endorsement, Dr. Roger Hastings writes: "To date we have been pouring huge funds into nuclear fusion in search of this dream. It appears that Mr. Newman has found the solution on a scale which will allow immediate and economically reliable development."

As Joe Newman says, "The finished prototype of what I teach will change the world drastically for the good of mankind, more so than any invention before this time."

For the first time in our history, this book — THE ENERGY MACHINE OF JOSEPH NEWMAN — discloses the principles and technology required to create a totally new method of energy generation via "an invention whose time has come."

THE AUTHOR'S PURPOSE

To those who may be inspired by what I have written within this book – it is to you that I write the following:

There has never been anything written before my work that was complete in terms of answering all there is to know on any given subject. There is also nothing that I have written in this book which represents any final aspect of knowledge and, for the future, I doubt that there will ever be an end to the quest for knowledge in any intellectual domain.

Any previously established and accepted subject matter is incomplete if it cannot clearly and distinctly provide an answer to any question (appropriate to that subject matter) which is posed by the mind of an honest and inquisitive person.

With what I present in this book, I do not endeavor to awe you but, on the contrary, I wish to *inspire* you to "stand on my shoulders and see further than I have seen" (to paraphrase Isaac Newton). It is my purpose to enable you to teach others to question everything and to accept nothing blindly. Likewise, do not blindly accept what I present in this book, just as you should not blindly accept that which is taught in any given historical age. You have before you the evidence of history to verify the error of blind, non-intellectual acceptance of dogma. In essence, I wish to encourage all people to "THINK FOR THEMSELVES."

The new source of energy which I disclose in this book is not the ultimate discovery. On the contrary. The energy which I have discovered is as basic as the WHEEL itself, and such energy will vastly improve the qualitative life of our human species. Moreover, World Peace can result from such improvement.

I foresee in the future that expanded space travel will become an exciting reality as a result of the utilization of this new source of energy. All aspects of science will be greatly enhanced by the thorough mastery of what I present in this book and, as a result, beneficial changes of a phenomenal nature will quickly occur for our species.

If I can only bestow upon the reader the excitement and enchantment which I foresee within the immediate grasp of our human species: access to energy will no longer be a problem and there will be a successful merger between economics and automation. Moreover, the mysteries within the Universe will be experienced by our children and their descendants.

The reader will find that I discuss many different but related topics within this book. Read carefully what I have written and you will discover that I have no ulterior motive other than a sincere quest for "Absolute Truth."

Over sixteen years ago, I wrote –

To all peoples whose brain burns and aches to accomplish great things and changes for the good, may God and/or the Goodness of the Universe be with you. For you are the Goodness of the Universe and do good for people in spite of themselves. And I salute you!

JOSEPH WESTLEY NEWMAN

"The future of the human race may be dramatically uplifted by the large scale commercial development of this invention."

– DR. ROGER HASTINGS
Principal Physicist, Sperry-Univac Corporation

\$34.95 (add \$3.50 for shipping and handling in U.S.)

To order, send **\$38.45** total to:

JOSEPH NEWMAN PUBLISHING CO.

Route 1, Box 52, Lucedale, Mississippi 39452

FOR POSTAGE COSTS TO CANADA AND MEXICO ADD:

\$7.50 (Airmail) or \$2.50 (Surface*)

FOR OVERSEAS POSTAGE COSTS TO EUROPE, FAR EAST, ETC., ADD:

\$22.50 (Airmail) or \$2.50 (Surface*)

[* Allow 8 weeks for shipping time.]

ISBN: 0-9613835-6-9

VCR Tapes now available!

★★★★★★★★★★★★★★★★★★★★

ITEM #3 (See reverse)

VCR TAPE OF JOSEPH NEWMAN'S LOUISIANA STATE UNIVERSITY PRESENTATION

On Wednesday evening, February 25, 1986, inventor Joseph Newman presented his electromagnetic theories and technical processes before 1500 people in the main auditorium of Louisiana State University in Baton Rouge, Louisiana. This event was sponsored by the American Society of Mechanical Engineers (Student Chapter), the LSU College of Design, and the HELENE Foundation.



In this excellent and visually graphic presentation, Joseph Newman gives an overview of the events that led to his mechanical understanding of magnetic attraction and repulsion and he explains the technical processes relating to his concepts of electromagnetism. In addition, by hearing the anecdotes that affected his life, the audience had the opportunity to know the "human side" of Joseph Newman the inventor. This tape features a large number of slides and graphics that highlight and illustrate the subject matter in this presentation.

Apr. 60 minutes, \$39.95
(Add \$6.00 for OVERSEAS postage.)

*Industrial grade quality.
Available in VHS or BETA. Originally filmed on 3/4" tape.*

ITEM #4 (See reverse)

VCR TAPE OF JOSEPH NEWMAN'S LOUISIANA SUPERDOME PRESENTATION

From Friday, April 11, 1986 - Thursday, April 17, 1986, Joseph Newman held a continuous energy machine demonstration in the Louisiana Superdome. Over 8,500 people from across the country attended this event which featured an apr. 180-pound energy machine (with a reciprocating magnet armature operating with high voltage/very low amperage input) that powered a variety of lights. In addition, Joseph Newman had various magnetic demonstrations which further proved that a magnetic field is a kinetic river of energy.

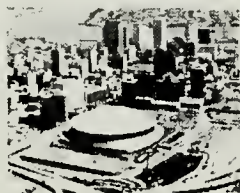

As Dr. Roger Hastings has stated, "The significance of high voltage on the Newman motor is that our data show that 1) the output power increases as the square of the input voltage, 2) the input power increases linearly with the voltage, 3) the motor efficiency increases linearly with the voltage, 4) output power levels required, for example, to power a home will require input voltages estimated at ten to twenty kilovolts." This tape features the Wednesday evening presentation on April 16, 1986.

Apr. 60 minutes, \$29.95
(Add \$6.00 for OVERSEAS postage.)

*Consumer grade quality.
Available in VHS or BETA. Originally filmed on 1/2" tape.*

ITEM #5 (See reverse)

VCR TAPE OF JOSEPH NEWMAN'S JACKSON, MISSISSIPPI NEWS CONFERENCE/DEMONSTRATION

In the Sheraton Regency Hotel on Wednesday, August 20, 1986 at 10:30AM, inventor Joseph Newman operated his latest, portable, home appliance fan motor and also demonstrated the practicality of a revolutionary electromagnetic lifting and motion device for Earth and space travel. He demonstrated — contrary to conventional scientific teaching — that the electromagnetic effect occurring between objects can be made to consistently repel regardless of whether a magnetic entity has its poles reversed or whether the current in a conductor is reversed.

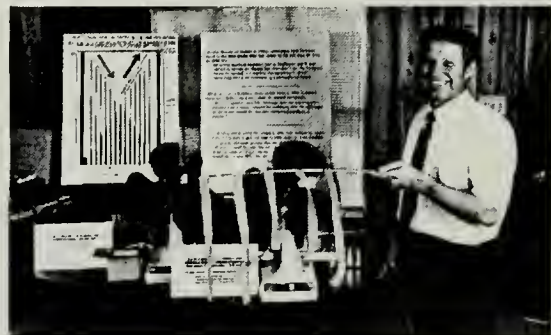

In his Declaration of August 22, 1986 (see ITEM #17 on reverse), Dr. Hastings wrote: "The levitation experiment demonstrated a vertical force exceeding the force of gravity on strands of #40 copper wire when a few hundred milliamps were applied." The watts needed to power the Newman-motor-connected-fan at high speed is 6.9 watts (.003 amps X 2300 volts). In addition, six times the current is going back into the batteries than comes out of the batteries. To equal the speed of the Newman-motor-connected-fan, the input into the conventional fan must be raised to 28.5 watts (.38 amps X 75 volts).

Apr. 60 minutes, \$29.95
(Add \$6.00 for OVERSEAS postage.)

*Consumer grade quality.
Available in VHS or BETA. Originally filmed on 1/2" tape.*

ORDER FORM — All Prices Include Postage & Handling

Item #	Cost Each	Quantity	\$ Total
(1) Subscription to the ENERGY MACHINE NEWSLETTER (You can also order for your friends, business associates, etc.)	\$ 15.00		
(2) THE ENERGY MACHINE OF JOSEPH NEWMAN , 310 pgs (price includes postage & handling in U.S.), additional postage to CANADA & MEXICO \$7.50 (airmail) or \$2.50 (surface); OVERSEAS: \$22.50 (airmail) or \$2.50 (surface).	38.45		
(3) VCR TAPE of Joseph Newman's LOUISIANA STATE UNIVERSITY PRESENTATION (2/25/86) [please check: <input type="checkbox"/> VHS or <input type="checkbox"/> BETA (if unchecked, VHS will be mailed)] (Add \$6.00 OVERSEAS Postage)	39.95		
(4) VCR TAPE of Joseph Newman's LOUISIANA SUPERDOME PRESENTATION (4/16/86) [please check: <input type="checkbox"/> VHS or <input type="checkbox"/> BETA (if unchecked, VHS will be mailed)] (Add \$6.00 OVERSEAS Postage)	29.95		
(5) VCR TAPE of Joseph Newman's JACKSON, MISS. NEWS CONFERENCE/DEMONSTRATION (8/20/86) [please check: <input type="checkbox"/> VHS or <input type="checkbox"/> BETA (if unchecked, VHS will be mailed)] (Add \$6.00 OVERSEAS Postage)	29.95		
(6) Copy of New Sections in latest Edition of THE ENERGY MACHINE OF JOSEPH NEWMAN , 32 pgs	3.60		
(7) Extra Book Order Forms (in quantity)	.10		
(8) MAIN FLYER : FACTS CONCERNING THE ENERGY MACHINE OF JOSEPH NEWMAN, 2 pgs.	.25		
(9) BUMPERSTICKER : "The ENERGY MACHINE — An Invention Whose Time Has Come" (gold on burgundy)	1.60		
(10) GLOSSY PHOTOGRAPHS of JOSEPH NEWMAN (5"x7")			
		BLACK & WHITE	4.00
		COLOR	6.00
(11) DIXIE MAGAZINE ARTICLE (9/29/85), 6 pgs., w/pictures, large format	2.25		
(12) COLLECTION OF PRESS RELEASES (4/17/85 - 10/17/85), 28 pgs.	3.50		
(13) COLLECTION OF PRESS RELEASES (1/27/86 - 10/6/86), 35 pgs.	4.50		
(14) SPECIAL MASTER'S REPORT, 20 pgs.	2.50		
(15) REPUBLICAN STUDY COMMITTEE OF CONGRESS, REPORT, 5 pgs.	.80		
(16) SET OF ALL ITEMS LISTED BELOW: #17 - #47	26.00		
(17) 4 DISCLOSURE STATEMENTS by Dr. Hastings (9/20/85, 6/19/86, 7/4/86, 8/22/86), 4 pgs.	.80		
(18) 3 ARTICLES by national columnist James J. Kilpatrick, 3 pgs.	.60		
(19) IMPORTANT ASSORTMENT of items: FACT SHEET, Events History, Oscillographs, etc., 12 pgs.	2.00		
(20) EXCELLENT REGARDIES ARTICLE on Joseph Newman, 12/85, 8 pgs.	1.40		
(21) "GENERAL BACKGROUND INFORMATION" on the Energy Machine, by Evan Soule, Jr., 5 pgs.	.80		
(22) "Joseph Newman Battles with the PTO" by Evan Soule, Jr., 3 pgs.	.60		
(23) Sample form letter to send to Congressmen & Senators, 1 pg.	.40		
(24) "JOSEPH NEWMAN NEEDS YOUR HELP" Flyer w/scientists' supporting quotes, 2 pgs.	.50		
(25) "Energy Machine Wows Crowd at Superdome" article, with photos, 1 pg.	.40		
(26) DR. NICHOLAS TSOUPIAS' LETTER re Joseph Newman plus supporter's ltr., 2 pgs.	.50		
(27) Ken Arno Letter from Gravitation, Energy Research & Development Co., 2 pgs.	.50		
(28) IMPORTANT COLLECTION of Numerous Interviews & Articles beginning with the MONEYCHANGER: "Free Energy: An Interview with Joseph Newman," plus many more articles, 21 pgs.	2.50		
(29) UNIVERSITY OF NEW ORLEANS, Center for Economic Development ltr., 4 pgs.	.80		
(30) COPY OF TEN BILLS IN THE HOUSE OF REPRESENTATIVES to grant the patent, 2 pgs.	.50		
(31) LIST OF CONGRESSMEN on House Subcommittee w/patent Bills & reasons for passage, 4 pgs.	.75		
(32) CONGRESSIONAL CORRESPONDENCE, including 2 long letters by CONGRESSMAN LIVINGSTON, 15 pgs.	2.20		
(33) MISSISSIPPI HOUSE & SENATE RESOLUTIONS, NEW ORLEANS CITY COUNCIL RESOLUTION, & Press Release re Misappropriations of Government Funds by PTO, 8 pgs.	1.40		
(34) INFORMATION re CONGRESSMAN ROBERT KASTENMEIER'S opposition, 1 pg.	.40		
(35) Testimony of JOSEPH NEWMAN, JOHN FLANNERY, DR. ROGER HASTINGS & MILTON EVERETT before the Senate Subcommittee on Energy (7/30/86), 16 pgs.	2.30		
(36) Testimony of CONGRESSMEN KINDNESS, LIVINGSTON, DOWDY, LOTT & SENATOR STENNIS before the Senate Subcommittee on Energy (7/30/86), 3 pgs.	.75		
(37) PHILADELPHIA INQUIRER, Front Page Article on J. Newman (3/21/85), 11"x17", 2 pgs.	.80		
(38) ATLANTA CONSTITUTION, Front Page Article: "What I Have Done Will Revolutionize the World" (7/13/86), 2 pgs.	.50		
(39) COLUMBUS DISPATCH, Front Page Article on J. Newman (7/31/86), 1 pg.	.40		
(40) CLARION-LEDGER article on JACKSON, MISS. NEWS CONFERENCE (8/21/86), 1 pg.	.40		
(41) 3 ARTICLES FEATURING HILTON HOTEL DEMONSTRATION (10/9/85), 2 pgs.	.50		
(42) "A VIABLE ENERGY ALTERNATIVE," Letter to Editor by Evan Soule, Jr., 1 pg.	.40		
(43) "Newman's Machine," Letter to Editor by Richard Stone (8/14/86), 1 pg.	.40		
(44) HEALTH FREEDOM NEWS ARTICLE on Joseph Newman by Clinton Ray Miller (4/86), 4 pgs.	.80		
(45) "The PTO's 'Expert' Witness: the NBS" [A Chronology], 2 pgs.	.50		
(46) 7 ARTICLES: "Tale of Red Tape," "Joseph Newman Energy Machine on Display," "Joseph Newman Takes to Superdome," "Inventor Hoping Perpetual Effort Will Secure Patent," "Inventor Takes Fight to House," "Newman Discusses Energy Machine Battle," "Inventor Newman Demonstrates New Device in Jackson," 11 pgs.	1.80		
(47) 10 ARTICLES: "New Fight in Battle for Energy Machine" (11/15/85), "Inventor Battles for EM" (11/23/85), "Inventor Awaits Test of Machine" (2/15/86), "America Kept From Getting Free Electricity" (2/21/86), "The Inventor vs. the PTO" (2/24/86), "One Man's Tangle with the PTO" (5/21/86), "Newman's Battle Continues" (6/19/86), "Electronic Design Article" (7/24/86), "Miss. Man Seeks EM Patent" (7/31/86), "Inventor Presents Case to Congress" (8/11/86), 13 pgs.	2.10		

SUBTOTAL: \$ _____
 (6% Sales Tax, Miss. residents only): \$ _____
 TOTAL: \$ _____

TO ORDER ITEMS, PLEASE PRINT CLEARLY THE FOLLOWING AND RETURN THIS COMPLETE PAGE

[Another order form will be shipped with your order. VCR tapes may be shipped separately. Checks are acceptable — money orders will expedite processing.]

I have enclosed a money order for \$ _____ payable to the JOSEPH NEWMAN PUBLISHING COMPANY for the items listed above.

Please send items to:

Name: _____
 Address: _____
 City: _____ State: _____ Zip: _____

Check here if you would like to receive free investment information should it become available.
 Check here if you wish to be informed of other VCR tapes when available.

If you have particular skills or interests that could be utilized for energy machine production purposes, please let us know (a resume' would be useful).

Please allow 2-3 weeks for delivery.

Send this form to: **JOSEPH NEWMAN PUBLISHING CO., Route 1, Box 52, Iucedale, Mississippi 39452**

★ ☆ ★ ☆ ★ ☆ ★ **New VCR Tape now available!** ★ ☆ ★ ☆ ★ ☆ ★

VCR TAPE OF JOSEPH NEWMAN'S ELECTRIC AUTOMOBILE DEMONSTRATION AT BILOXI, MISSISSIPPI

On Wednesday morning, March 11, 1987, inventor Joseph Newman demonstrated his revolutionary electric automobile in the Biloxi Coliseum before apr. 750 people and newsmedia. This videotape contains footage of the automobile as well as other demonstrations, slides and graphics.

Apr. 60 minutes, \$29.95
(Add \$6.00 for OVERSEAS postage.)
(Miss. residents add 6% sales tax.)

*Industrial grade quality.
Please specify VHS or BETA.*

[Note: EM's RF energy is audible on the tape.]

ORDER FROM: **JOSEPH NEWMAN PUBLISHING CO., Route 1, Box 52, Lucedale, MS 39452**

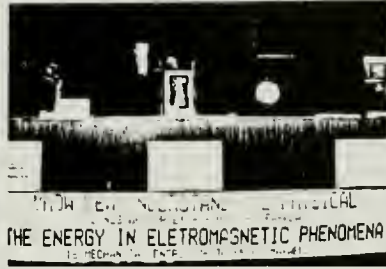

For those individuals who have ordered this book through a bookstore, if you would like to receive future mailings concerning the development of the energy machine, please send your name and address to:

JOSEPH NEWMAN PUBLISHING COMPANY
Route 1, Box 52
Lucedale, Mississippi 39452

[Please indicate that you received your book through a bookstore. *Thank you!*]

